

**Anritsu** envision : ensure

# VectorStar®

High Performance, Broadband Network Analysis Solutions

## MS4640B Series

Microwave Vector Network Analyzers

- MS4642B (Optional 70 kHz) 10 MHz to 20 GHz
- MS4644B (Optional 70 kHz) 10 MHz to 40 GHz
- MS4647B (Optional 70 kHz) 10 MHz to 70 GHz

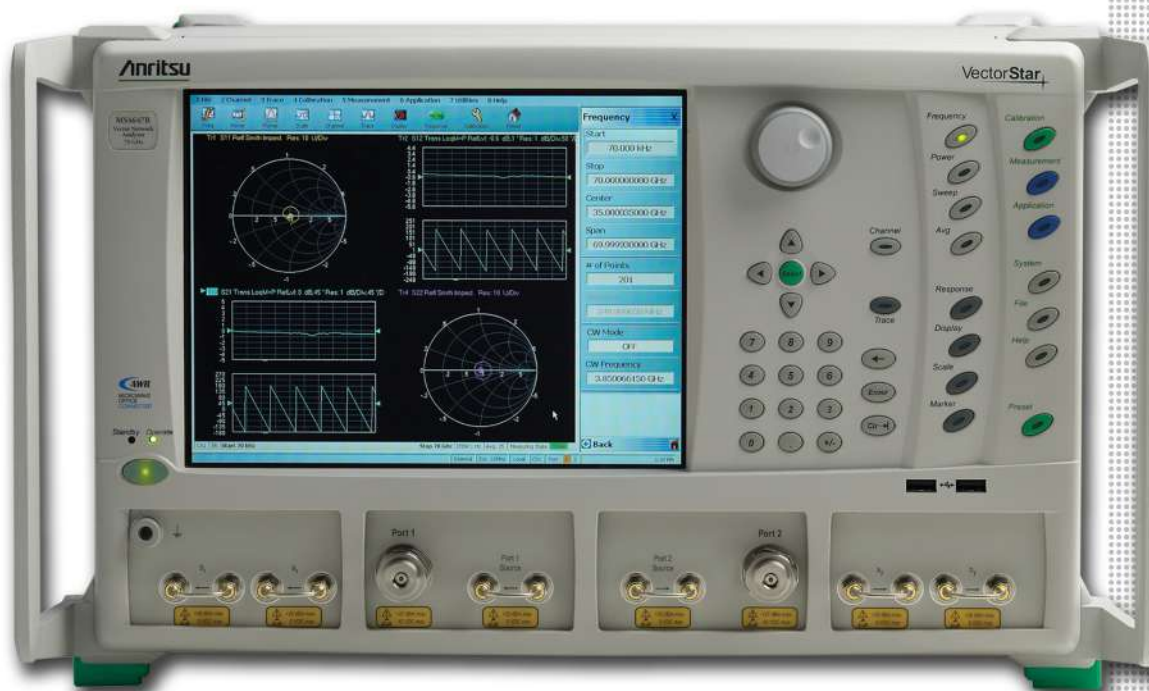

## Introduction

This document provides detailed specifications for the MS4640B series microwave Vector Network Analyzers (VNAs) listed below, including all related options, and accessories.

### Instrument Models and Operating Frequencies

- MS4642B – (Optional 70 kHz) 10 MHz to 20 GHz
- MS4644B – (Optional 70 kHz) 10 MHz to 40 GHz
- MS4647B – (Optional 70 kHz) 10 MHz to 70 GHz
- Extended Operating Frequency Details Inside

### Principal Options

- MS4640B-002 – Time Domain
- MS4640B-007 – Receiver Offset
- MS4640B-021 – Universal Fixture Extraction
- MS4640B-031 – Dual Source Architecture
- MS4640B-032 – Internal RF Combiner
- MS4640B-035 – IF Digitizer
- MS4640B-036 – Extended IF Digitizer Memory
- MS4640B-041 – Noise Figure
- MS4640B-042 – PulseView™
- MS4640B-043 – DifferentialView™
- MS4640B-044 – IMDView™
- MS4640B-046 – Fast CW
- MS4640B-047 – Eye Diagram
- MS4640B-048 – Differential Noise Figure
- MS4640B-051 – Direct Access Loops
- MS4640B-053 – External ALC
- MS4640B-061/062 – Active Measurements Suite
- MS4640B-070 – 70 kHz Low-End Frequency Extension

A detailed color brochure available on the Anritsu web site provides descriptions and examples of the VectorStar family's features and benefits. The web site also provides detailed information on 110 /125/145/220 GHz Broadband Coaxial, Banded Waveguide, and Multiport solutions based on the MS4640B VNA:

(<https://www.anritsu.com/en-us/test-measurement/products/ms4640b-series>)

**Table of Contents**

Introduction ..... 2

Definitions ..... 4

System Dynamic Range ..... 5

Receiver Dynamic Range ..... 6

Receiver Compression ..... 6

High Level Noise ..... 7

Noise Floor ..... 7

Power Range ..... 9

Output Default Power ..... 11

Power Accuracy, Linearity, and Resolution ..... 11

Measurement Stability ..... 11

Frequency Resolution, Accuracy, and Stability ..... 11

Phase Noise, Harmonics, and Non-Harmonics (Spurious) ..... 11

Uncorrected (Raw) Port Characteristics ..... 12

Power Range with Option 32 ..... 12

MS4642B 20 GHz VNA System Performance ..... 14

MS4644B 40 GHz VNA System Performance ..... 20

MS4647B 70 GHz VNA System Performance ..... 24

Measurement Times ..... 34

Standard Capabilities ..... 35

Remote Operability ..... 37

Calibration and Correction Capabilities ..... 38

Optional Capabilities ..... 39

CPU, OS, Memory, and Security Features ..... 44

Front Panel Connections ..... 45

Rear Panel Connections ..... 46

Mechanical and Environmental ..... 48

Regulatory Compliance ..... 48

Warranty ..... 49

Block Diagram ..... 49

MN4765B O/E Calibration Module ..... 50

MN4775A E/O Converter Features ..... 52

36585-Series Automatic Calibrators (AutoCal) ..... 53

Mechanical Calibration Kits ..... 54

Verification Kits ..... 58

Precision Adapters, Attenuators, and Other Components ..... 58

Test Port Cables ..... 59

Universal Test Fixture (UTF) ..... 60

Ordering Information ..... 61

Extended Service Options ..... 65

**Definitions**

	All specifications and characteristics apply under the following conditions, unless otherwise stated:
Warm-Up Time	After 90 minutes of warm-up time, where the instrument is left in the ON state.
Temperature Range	Over the 25 °C ± 5 °C temperature range.
Error-Corrected Specifications	For error-corrected specifications, over 23 °C ± 3 °C, with < 1 °C variation from calibration temperature. For error-corrected specifications are warranted and include guard-bands, unless otherwise stated.
Frequency Bands in Tables	When a frequency is listed in two rows of the same table, the specification for the common frequency is taken from the lower frequency band, except when the band edge is less than 5 GHz.
User Cables	Specifications do not include effects of any user cables, adapters, or fixtures attached to the instrument.
Discrete Spurious Responses	Specifications may exclude discrete spurious responses.
Internal Reference Signal	All specifications apply with internal 10 MHz Crystal Oscillator Reference Signal.
Interpolation Mode	All specifications are with Interpolation Mode Off.
Standard	Refers to instruments without Option 51, 61, or 62.
Typical Performance	Typical performance indicates the measured performance of an average unit. It does not include guard-bands and is not covered by the product warranty. Typical specifications are shown in parentheses, such as (-102 dB), or noted as typical.
Characteristic Performance	Characteristic performance indicates a performance designed-in and verified during the design phase. It does include guard-bands and is not covered by the product warranty.
Nominal Performance	Nominal performance indicates a performance designed in and observed during the design phase. It does not include guard bands, is not production tested, and is not covered by the product warranty.
Below 300 kHz	All uncertainties below 300 kHz are typical.
Recommended Calibration Cycle	12 months (Residual specifications also require calibration kit calibration cycle adherence.)
Specifications Subject to Change	All specifications subject to change without notice. For the most current data sheet, please visit the Anritsu web site: <a href="http://www.anritsu.com">www.anritsu.com</a>

The instrument may be protected by one or more of the following patents: 6894581, 7088111, 7545151, 7683633, 7924024, 8185078, 8306134, 8417189, 8718586, 9103873, 9606212, 9753071, 10225073 depending on the model and option configuration of the instrument.

**System Dynamic Range**

System dynamic range is calculated as the difference between the maximum rated source power and the specified noise floor at the specified reference plane. Option 31 System Dynamic Range is listed in alternating tables. Note that Option 32 System Dynamic Range differs by the delta in max power.

MS4642B 20 GHz Model, System Dynamic Range (dB)		
Frequency (GHz)	at Ports 1 or 2	
	Option 61 <sup>a</sup> or 62	
0.07 to 0.3 MHz	81	
> 0.3 to 2 MHz	98	
> 2 to 10 MHz	111	
> 0.01 to < 2.5	114	
2.5 to 20	115	
<b>With Option 31</b>		
0.07 to 0.3 MHz	83	
> 0.3 to 2 MHz	100	
> 2 to 10 MHz	113	
> 0.01 to < 2.5	116	
2.5 to 20	116	

MS4644B 40 GHz Model, System Dynamic Range (dB)					
Frequency (GHz)	at Ports 1 or 2			at b <sub>1</sub> or b <sub>2</sub>	
	Standard	Option 51	Option 61 <sup>b</sup> or 62	Option 51	Option 61 <sup>b</sup> or 62
0.07 to 0.3 MHz	85	83	81	114	112
> 0.3 to 2 MHz	102	100	98	126	124
> 2 to 10 MHz	115	113	111	134	132
> 0.01 to < 2.5	122	119	114	140	135
2.5 to 40	119	115	110	130	125
<b>With Option 31</b>					
0.07 to 0.3 MHz	87	85	83	116	114
> 0.3 to 2 MHz	104	102	100	128	126
> 2 to 10 MHz	117	115	113	136	134
> 0.01 to < 2.5	129	121	116	142	137
2.5 to 40	122	118	113	133	128

MS4647B 70 GHz Model, System Dynamic Range (dB)					
Frequency (GHz)	at Ports 1 or 2			at b <sub>1</sub> or b <sub>2</sub>	
	Standard	Option 51	Option 61 <sup>b</sup> or 62	Option 51	Option 61 <sup>b</sup> or 62
0.07 to 0.3 MHz	85	83	81	114	112
> 0.3 to 2 MHz	102	100	98	126	124
> 2 to 10 MHz	115	113	111	134	132
> 0.01 to < 2.5	122	119	114	140	135
2.5 to 5	116	112	106	127	121
> 5 to 20	115	111	105	126	120
> 20 to 38	116	111	105	126	120
> 38 to 50	115	109	104	124	119
> 50 to 65	110	104	99	119	115
> 65 to 67	108	103	95	117	111
> 67 to 70	107	100	90	110	106
<b>With Option 31</b>					
0.07 to 0.3 MHz	87	85	83	116	114
> 0.3 to 2 MHz	104	102	100	128	126
> 2 to 10 MHz	117	115	113	136	134
> 0.01 to < 2.5	124	121	116	142	137
2.5 to 5	118	114	108	129	123
> 5 to 20	118	114	108	129	123
> 20 to 38	118	113	107	128	122
> 38 to 50	117	111	106	126	121
> 50 to 65	117	111	106	126	122
> 65 to 67	116	111	103	125	119
> 67 to 70	114	107	97	120	113

a. The Option 61 dynamic range reported in this column corresponds to S<sub>21</sub>. For S<sub>12</sub>, add 2 dB.

b. The Option 61 dynamic range reported in this column applies for S<sub>21</sub> measurements. For S<sub>12</sub> dynamic range, use the figures from the Option 51 column.

## Receiver Dynamic Range

Calculated as the difference between the maximum receiver input level for 0.1 dB compression and the specified noise floor at the specified reference plane. Characteristic Performance.

### All Models, Receiver Dynamic Range (dB)

Frequency (GHz)	at Ports 1 or 2			at b <sub>1</sub> or b <sub>2</sub>	
	Standard <sup>a</sup>	Option 51 <sup>a</sup>	Option 61 <sup>b,c</sup> or 62	Option 51 <sup>a</sup>	Option 61 <sup>c</sup> or 62
0.07 to 0.3 MHz	80	79	78	90	89
> 0.3 to 2 MHz	102	102	102	107	107
> 2 to 10 MHz	115	115	115	115	115
> 0.01 to < 2.5	120	119	116	119	116
2.5 to 5	120	118	115	117	114
> 5 to 20	120	118	115	118	115
> 20 to 40 <sup>d</sup>	120	118	115	118	116
> 38 to 50	120	118	117	117	117
> 50 to 65	117	115	115	113	114
> 65 to 67	115	113	111	110	109
> 67 to 70	113	110	109	107	108

a. Not applicable to MS4642B.

b. The Option 61 dynamic range reported in this column applies for S21 measurements. For S12 dynamic range, use the figures from the Option 51 column.

c. The Option 61 dynamic range reported in this column corresponds to S21. For S12, add 2 dB.

d. 20 to 38 GHz for MS4647B.

## Receiver Compression

Port power level beyond which the response may be compressed more than 0.1 dB relative to the normalization level. 10 Hz IF bandwidth used to remove any high level noise effects. Match not included. Performance is characteristic. In pulse modes (Option 42), compression is measured with 1 kHz IF bandwidth and the compression level is 0.3 dB below 1 GHz.

### All Models, Compression Levels (dBm)

Frequency (GHz)	0.1 dB Compression Levels in dBm relative to the Normalization Level <sup>a</sup>					
	at Ports 1 or 2			at a <sub>x</sub> loops	at b <sub>x</sub> loops	
	Standard <sup>b</sup>	Option 51 <sup>b</sup>	Option 61 <sup>c</sup> or 62	Option 51, 61, or 62	Option 51 <sup>b</sup>	Option 61 <sup>c</sup> or 62
0.07 to 0.3 MHz	+5	+5	+5	-15	-15	-15
> 0.3 to 10 MHz	+10	+11	+12	-10	-10	-9
> 0.01 to < 2.5	+10	+11	+12	-10	-10	-9
2.5 to 5	+10	+11	+12	-5	-5	-4
> 5 to 20	+10	+11	+12	-4	-4	-3
> 20 to 40 <sup>d</sup>	+10	+11	+12	-4	-4	-2
> 38 to 50	+10	+12	+14	-4	-4	-1
> 50 to 65	+10	+12	+14	-5	-5	-2
> 65 to 67	+10	+13	+15	-5	-5	-2
> 67 to 70	+10	+13	+15	-5	-5	-1

a. 0.3 dB for < 0.3 MHz.

b. Not applicable to MS4642B.

c. The Option 61 compression level reported in this column applies to Port 2 or b2. For MS4642B Port 1 or b1, subtract 1 dB. For all other models Port 1 or b1, use the figures from the appropriate Port X or b<sub>x</sub> Option 51 column.

d. 20 to 38 GHz for MS4647B.

During intermodulation measurements it is useful to know the linearity of the receiver. In addition to considering the receiver compression point, it is helpful to understand the third order Intercept Point (IP3) of the receiver. IP3 can therefore be used as a figure of merit to describe the range and quality of IMD measurements. The nominal IP3 performance provided is valid with or without the Option 32 combiner and represents the receiver performance at the input of the test port. Minimal degradation of IP3 at different tone spacings. For the approximate IP3 of the receiver at the sampler input, deduct ~13 dB from the numbers below. The spec values below were derived by using -10 dBm/tone power incident at the receive port, a tone spacing of 3 MHz (reducing to frequency/10 for frequencies under 30 MHz) and an IF bandwidth of no more than 10 Hz.

### All Models, Third Order Intercept Point (IP3, dBm)

Frequency Range	At Port 2 (Nominal)
0.07 MHz to 0.3 MHz	+20
0.3 MHz to 1.0 GHz	+25
> 1.0 GHz to 20/40/70 GHz (max frequency of the models)	+35

### High Level Noise

Measured at 1 kHz IF bandwidth, at default power, with either full reflects or through transmission. RMS.

Characteristic performance on MS4647B.

High level noise magnitude may be degraded to 20 mdB RMS (typical) at particular frequencies due to receiver residuals.

Frequency (GHz)	Magnitude (dB)	Phase (degree)
70 kHz to 500 kHz	< 0.04	< 0.4
> 500 kHz to < 2.5	< 0.0045	< 0.05
2.5 to 5	< 0.0045	< 0.05
> 5 to 20	< 0.0045	< 0.05
> 20 to 40	< 0.006	< 0.06
> 40 to 67	< 0.006	< 0.08
> 67 to 70	< 0.008 (< 0.006)	< 0.08

### Noise Floor

Measured at 10 Hz IF Bandwidth with no averaging, and at -10 dBm port power. RMS, no leakage correction applied. Measurement made with a through line connection, with its effects compensated for. Performance at a<sub>x</sub> and b<sub>x</sub> loops is characteristic.

All Models, Noise Floor (dBm)						
Frequency (GHz)	At Ports 1 or 2			At a <sub>x</sub> Loops	At b <sub>x</sub> Loops	
	Standard <sup>a</sup>	Option 51 <sup>a</sup>	Option 61 <sup>b</sup> or 62	Option 51, 61, or 62	Option 51 <sup>a</sup>	Option 61 <sup>b</sup> or 62
0.07 to 0.3 MHz	-75	-74	-73	-105	-105	-104
> 0.3 to 2 MHz	-92	-91	-90	-117	-117	-116
> 2 to 10 MHz	-105	-104	-103	-125	-125	-124
> 0.01 to < 2.5	-110	-108	-104	-129	-129	-125
2.5 to 40 <sup>c</sup>	-110	-107	-103	-121	-122	-118
> 38 to 50	-110	-106	-103	-121	-121	-118
> 50 to 65	-110	-106	-103	-121	-121	-119
> 65 to 67	-110	-106	-100	-120	-120	-116
> 67 to 70	-110	-106	-100	-115	-119	-116

a. Not applicable to MS4642B.

b. The Option 61 noise floor reported in this column applies to Port 2 or b2. For MS4642B Port 1 or b1, the appropriate value is 1 dB more negative. For all other models Port 1 or b1, use the figures from the appropriate Port X or bx Option 51 column.

c. 2.5 GHz to 38 GHz for MS4647B.

MS4647B Example Noise Floor (Standard Configuration)

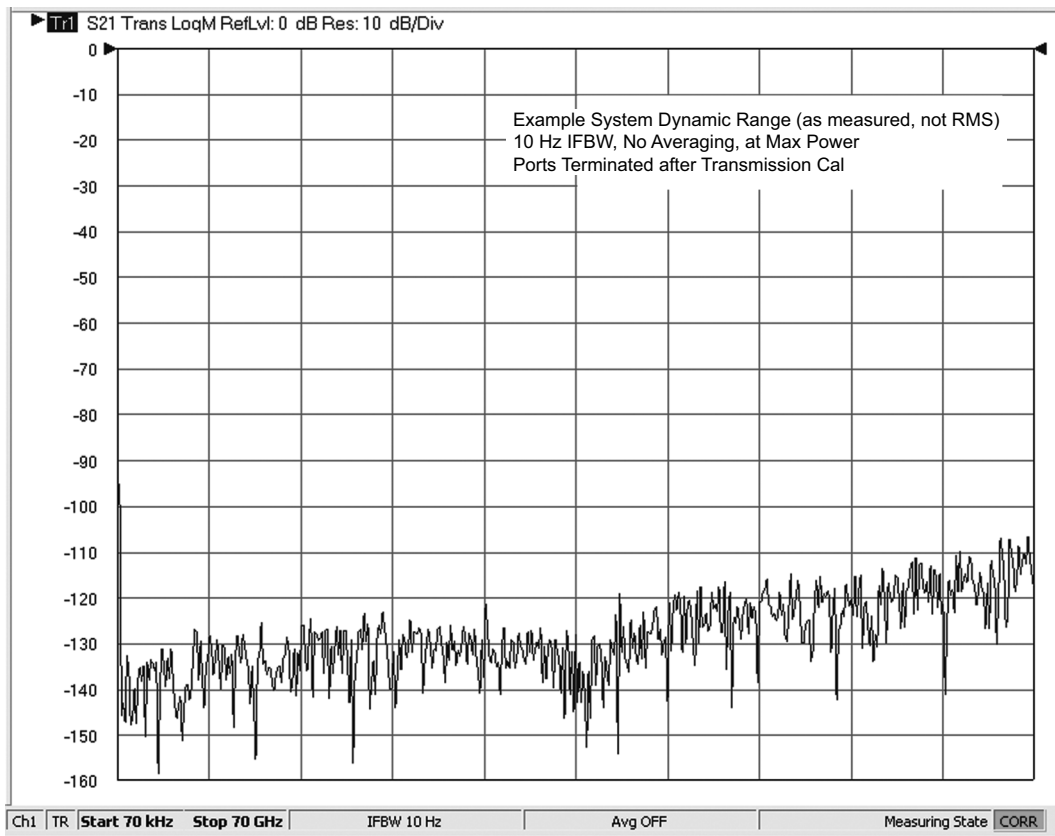
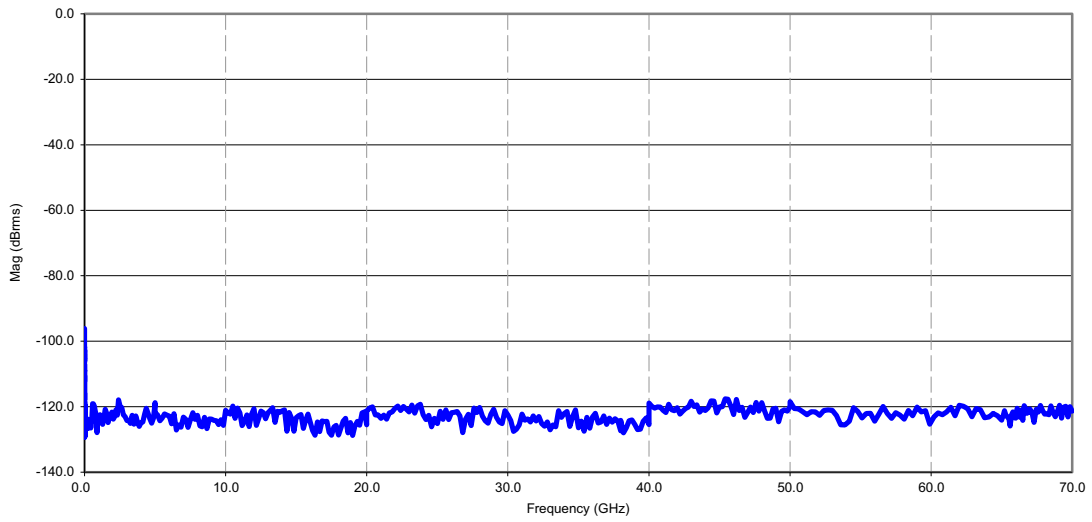

Example System Dynamic Range



**Power Range**

Maximum rated power to minimum level. The difference reflects the ALC range for standard models or with Option 51, and the ALC + attenuator range for models with Option 61 or 62. Maximum Rated Power is typical from 2.4 GHz to 2.7 GHz.

<b>MS4642B, 20 GHz Model, Power Range (dBm)</b>	
Frequency (GHz)	Option 61 <sup>a</sup> or 62
70 kHz to 0.01	+8 to -95
> 0.01 to < 2.5	+10 to -95
2.5 to 20	+11 to -90
<b>With Option 31</b>	
70 kHz to 0.01	+10 to -95
> 0.01 to < 2.5	+12 to -95
2.5 to 20	+12 to -90

a. For Option 61, the power range reported in this column applies to Port 1. For Port 2, add 1 dB to the maximum (minimum unchanged).

<b>MS4644B, 40 GHz Model, Power Range (dBm)</b>			
Frequency (GHz)	Standard	Option 51	Option 61 <sup>a</sup> or 62
70 kHz to 0.01	+10 to -25	+9 to -25	+8 to -95
> 0.01 to < 2.5	+12 to -25	+11 to -25	+10 to -95
2.5 to 20	+9 to -20	+8 to -20	+7 to -90
> 20 to 40	+9 to -25	+8 to -25	+7 to -95
<b>With Option 31<sup>b</sup></b>			
70 kHz to 0.01	+12 to -25	+11 to -25	+10 to -95
> 0.01 to < 2.5	+14 to -25	+13 to -25	+12 to -95
2.5 to 20	+12 to -20	+11 to -20	+10 to -90
> 20 to 40	+12 to -25	+11 to -25	+10 to -95

a. The Option 61 power range reported in this column applies to Port 1. For Port 2, use the figures from the Option 51 column.

b. With Option 8x, Test Port 2 maximum power is equivalent to the non-option 31 range (typical).

<b>MS4647B, 70 GHz Model, Power Range (dBm)</b>			
Frequency (GHz)	Standard	Option 51	Option 61 <sup>a</sup> or 62
70 kHz to 0.01	+10 to -25	+9 to -25	+8 to -85
> 0.01 to < 2.5	+12 to -25	+11 to -25	+10 to -85
2.5 to 5	+6 to -20	+5 to -20	+3 to -80
> 5 to 20	+5 to -20	+4 to -20	+2 to -80
> 20 to 38	+6 to -25	+4 to -25	+2 to -85
> 38 to 50 <sup>b</sup>	+5 to -25	+3 to -25	+1 to -85
> 50 to 65	0 to -25	-2 to -25	-4 to -85
> 65 to 67	-2 to -25	-3 to -25	-5 to -85
> 67 to 70	-3 to -25	-6 to -25	-10 to -85
<b>With Option 31<sup>c</sup></b>			
70 kHz to 0.01	+12 to -25	+11 to -25	+10 to -85
> 0.01 to < 2.5	+14 to -25	+13 to -25	+12 to -85
2.5 to 5	+8 to -20	+7 to -20	+5 to -80
> 5 to 20	+8 to -20	+7 to -20	+5 to -80
> 20 to 38	+8 to -25	+6 to -25	+4 to -85
> 38 to 50	+7 to -25	+5 to -25	+3 to -85
> 50 to 65	+7 to -25	+5 to -25	+3 to -85
> 65 to 67	+6 to -25	+4 to -25	+2 to -85
> 67 to 70	+4 to -25	+1 to -25	-3 to -85

a. The Option 61 power range reported in this column applies to Port 1. For Port 2, use the figures from the Option 51 column.

b. Rated power is typical 49 GHz to 50 GHz.

c. With Option 8x, Test Port 2 maximum power is equivalent to the non-option 31 range (typical). 38 to 50 GHz range may degrade by up to 3 dB.

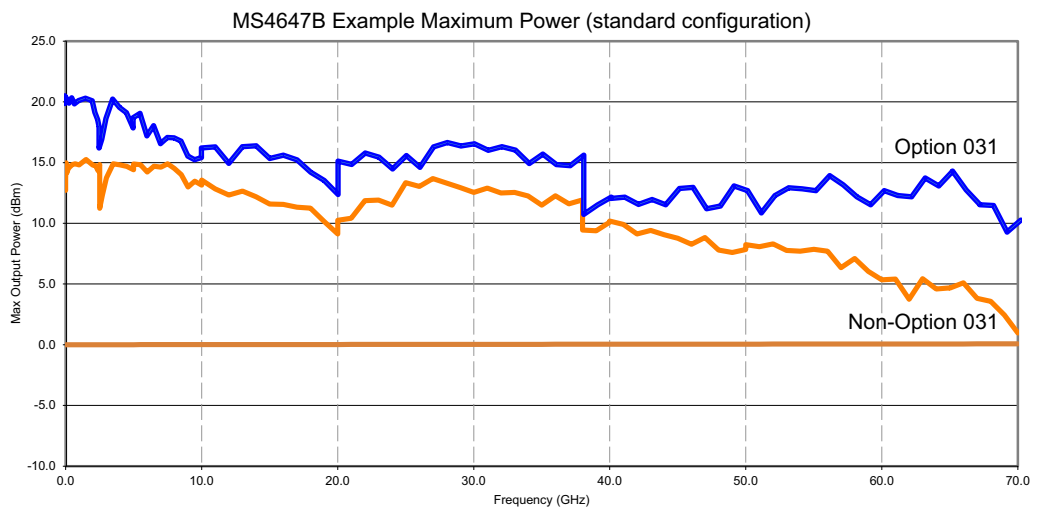
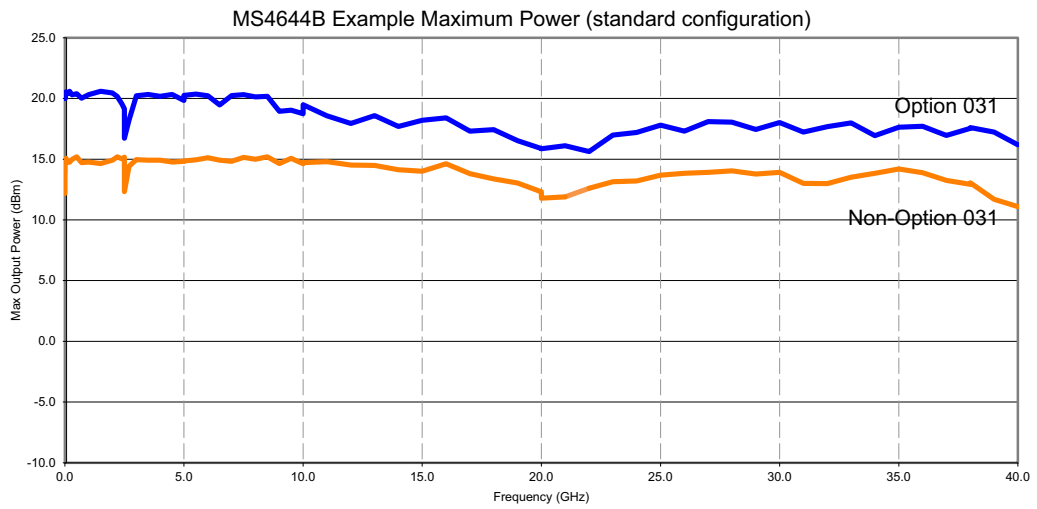
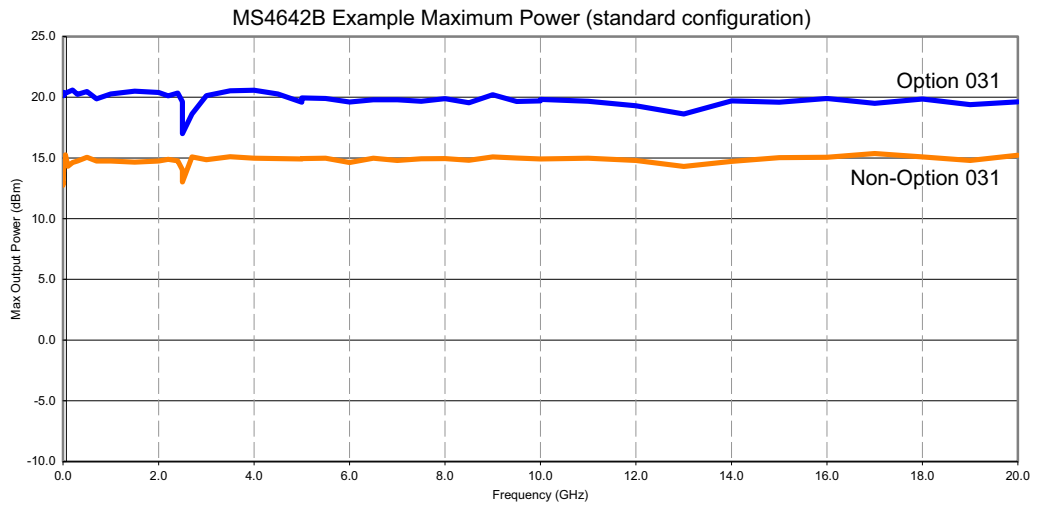

**Output Default Power**

Instrument default power. For maximum rated power, refer to “Power Range” above.

Model	Standard (No Options)	Option 51, 61, or 62
MS4642B, 20 GHz	NA	+5 dBm
MS4644B, 40 GHz	+5 dBm	+5 dBm
MS4647B, 70 GHz	-3 dBm <sup>a</sup>	-10 dBm

a. -5 dBm for MS4647B Option 8x systems.

**Power Accuracy, Linearity, and Resolution**

Frequency (GHz)	Accuracy <sup>a</sup> (dB)	Linearity <sup>b</sup> (dB)	Resolution (dB)
70 kHz to 0.01	± 1.5	± 1.5	0.01
> 0.01 to 40	± 1.5	± 1.0	0.01
> 40 to 67	± 3.0	± 1.0	0.01
> 67 to 70	± 4.0 (± 3.0)	± 2.0 (± 1.0)	0.01

a. Measured at default power.

b. Measured between default and 5 dB below default port power.

**Measurement Stability**

Ratio measurement, with ports shorted. Characteristic.

Frequency (GHz)	Magnitude (dB/°C)	Phase (degree/°C)
70 kHz to 0.01	< 0.04	< 0.4
> 0.01 to 20	< 0.02	< 0.2
> 20 to 40	< 0.03	< 0.5
> 40 to 67	< 0.03	< 0.7
> 67 to 70	< 0.04	< 0.8

**Frequency Resolution, Accuracy, and Stability**

Resolution	Accuracy	Stability
1 Hz	± 5 x 10 <sup>-7</sup> Hz/Hz (at time of calibration)	< 5 x 10 <sup>-9</sup> /°C over 0 °C to 50 °C temperature < 1 x 10 <sup>-9</sup> /day aging, instrument on

**Phase Noise, Harmonics, and Non-Harmonics (Spurious)**

Measured at default power. Phase Noise values are typical. Non-Harmonics are characteristic performance.

Frequency (GHz)	SSB Phase Noise (dBc/Hz) at 1 kHz Offset	SSB Phase Noise (dBc/Hz) at 10 kHz Offset	SSB Phase Noise (dBc/Hz) at 100 kHz Offset	Harmonics (dBc) (second and third)	Non-Harmonic Spurious (dBc) at > 1 kHz Offsets
70 kHz to 0.01	-86	-83	-88 <sup>a</sup>	-20	-20
> 0.01 to < 2.5	-90	-92	-96	-20	-30
2.5 to 5	-93	-94	-95	-20 <sup>b</sup>	-30
> 5 to 10	-86	-90	-90	-20	-30
> 10 to 20	-81	-84	-84	-20	-30
> 20 to 26.5	-78	-81	-81	-20	-30
> 26.5 to 40	-72	-76	-78	-20 <sup>b</sup>	-30
> 40 to 50	-70	-75	-75	-20	-30
> 50 to 70	-69	-71	-71	-20	-30

a. Only applies for source frequencies > 300 kHz.

b. Typical from 2.5 to 2.7 GHz on MS4642B systems and from 20.0 to 21.0 GHz on MS4647B systems.

## Uncorrected (Raw) Port Characteristics

Characteristic performance with Option 31, 51, 61, or 62.

Frequency Range (GHz)	Directivity (dB)	Port Match <sup>a</sup> (dB)
70 kHz to 0.01	> 10 <sup>b</sup>	> 8
> 0.01 to < 2.5	> 9 <sup>b</sup>	> 10
2.5 to 5	> 20	> 10
> 5 to 20	> 17	> 9
> 20 to 40	> 14	> 7
> 40 to 65	> 11	> 7
> 65 to 67	> 11	> 7
> 67 to 70	> 5 (> 10)	> 7

a. Port Match is defined as the worst of source and load match.

b. Raw Directivity degraded to 4 dB (typical) below 300 kHz and in a 300 MHz window below 2.5 GHz.

## Power Range with Option 32

Maximum rated power to minimum level. Option 32 System Dynamic range differs by the delta in max power.

### SOURCE1 to PORT1 POWER RANGE (dBm)

#### MS4642B, 20 GHz with Option 31 and Option 32

Frequency (GHz)	Option 61 or 62
70 kHz to 0.01	+8 to -95
> 0.01 to < 2.5	+10 to -95
2.5 to 20	+10 to -90

#### MS4644B, 40 GHz with Option 31 and Option 32

Frequency (GHz)	Standard	Option 51	Option 61 or 62
70 kHz to 0.01	+10 to -25	+9 to -25	+8 to -95
> 0.01 to < 2.5	+12 to -25	+11 to -25	+10 to -95
2.5 to 20	+10 to -20	+9 to -20	+8 to -90
> 20 to 40	+10 to -25	+9 to -25	+8 to -95

#### MS4647B, 70 GHz with Option 31 and Option 32

Frequency (GHz)	Standard	Option 51	Option 61 or 62
70 kHz to 0.01	+10 to -25	+9 to -25	+8 to -85
> 0.01 to < 2.5	+12 to -25	+11 to -25	+10 to -85
2.5 to 5	+6 to -20	+5 to -20	+3 to -80
> 5 to 20	+6 to -20	+5 to -20	+3 to -80
> 20 to 38	+6 to -25	+4 to -25	+2 to -85
> 38 to 50	+5 to -25	+3 to -25	+1 to -85
> 50 to 65	+5 to -25	+3 to -25	+1 to -85
> 65 to 67	+3 to -25	+1 to -25	-1 to -85
> 67 to 70	+2 to -25	-1 to -25	-5 to -85

**Power Range with Option 32 (Continued)**

**SOURCE2 to PORT2 POWER RANGE (dBm)**

**MS4642B, 20 GHz with Option 31 and Option 32**

Frequency (GHz)	Option 61 or 62
70 kHz to 0.01	+6 to -95
> 0.01 to < 2.5	+8 to -95
2.5 to 20	+9 to -90

**MS4644B, 40 GHz with Option 31 and Option 32**

Frequency (GHz)	Standard	Option 51	Option 61 or 62
70 kHz to 0.01	+8 to -25	+7 to -25	+6 to -95
> 0.01 to < 2.5	+10 to -25	+9 to -25	+8 to -95
2.5 to 20	+7 to -20	+6 to -20	+5 to -90
> 20 to 40	+7 to -25	+6 to -25	+5 to -95

**MS4647B, 70 GHz with Option 31 and Option 32**

Frequency (GHz)	Standard	Option 51	Option 61 or 62
70 kHz to 0.01	+8 to -25	+7 to -25	+6 to -85
> 0.01 to < 2.5	+10 to -25	+9 to -25	+8 to -85
2.5 to 5	+4 to -20	+3 to -20	+1 to -80
> 5 to 20	+3 to -20	+2 to -20	0 to -80
> 20 to 38	+4 to -25	+2 to -25	0 to -85
> 38 to 50 <sup>a</sup>	+3 to -25	+1 to -25	-1 to -85
> 50 to 65	-2 to -25	-4 to -25	-6 to -85
> 65 to 67	-4 to -25	-5 to -25	-7 to -85
> 67 to 70	-5 to -25	-8 to -25	-12 to -85

a. Rated power is typical 49 GHz to 50 GHz.

**SOURCE2 to PORT1 POWER RANGE (dBm, typical performance)**

**MS4642B, 20 GHz with Option 31 and Option 32**

Frequency (GHz)	Option 61 or 62
70 kHz to 0.01	-22 to -95
> 0.01 to < 2.5	-15 to -95
2.5 to 20	-11 to -95

**MS4644B, 40 GHz with Option 31 and Option 32**

Frequency (GHz)	Standard	Option 51 or 61	Option 62
70 kHz to 0.01	-20 to -25	-21 to -25	-22 to -95
> 0.01 to < 2.5	-13 to -25	-14 to -25	-15 to -95
2.5 to 20	-9 to -25	-10 to -25	-11 to -95
> 20 to 40	-8 to -25	-9 to -25	-10 to -95

**MS4647B, 70 GHz with Option 31 and Option 32**

Frequency (GHz)	Standard	Option 51 or 61	Option 62
70 kHz to 0.01	-20 to -25	-21 to -25	-22 to -85
> 0.01 to < 2.5	-13 to -25	-14 to -25	-15 to -85
2.5 to 5	-12 to -25	-13 to -25	-15 to -85
> 5 to 20	-11 to -25	-12 to -25	-14 to -85
> 20 to 38	-11 to -25	-13 to -25	-15 to -85
> 38 to 50	-12 to -25	-14 to -25	-16 to -85
> 50 to 65	-16 to -25	-18 to -25	-20 to -85
> 65 to 67	-17 to -25	-18 to -25	-20 to -85
> 67 to 70	-20 to -25	-23 to -25	-27 to -85

MS4642B 20 GHz VNA System Performance

MS4642B – 12-Term SOLT – Sliding Load – 3652A-1 K Calibration Kit

MS4642B 20 GHz Model, with 12-term SOLT with Sliding Load Calibration, using the 3652A-1 K Calibration Kit.

Frequency Range (GHz)	Directivity (dB)	Source Match (dB)	Load Match <sup>a</sup> (dB)	Reflection Tracking (dB)	Transmission Tracking (dB)
70 kHz to 0.01	> 38	> 36	> 38	± 0.02	± 0.05
> 0.01 to < 2.5	> 42	> 41	> 42	± 0.005	± 0.03
2.5 to 20	> 43	> 39	> 43	± 0.006	± 0.07

a. Since Residual Load Match is limited by Residual Directivity and the user test port cable, it can only be specified as Residual Directivity. For practical considerations, derate it by approximately 8 dB for a 3670 Series test port cable, to compensate for effects such as match, repeatability, bend radius, and similar parameters.

MS4642B Measurement Uncertainties

The graphs give measurement uncertainties after the above calibration. The errors are a worst-case contribution of residual directivity, load and source match, frequency response and isolation, network analyzer dynamic accuracy, and connector repeatability. 10 Hz IF Bandwidth is used. For transmission uncertainties, it is assumed that  $S_{11} = S_{22} = 0$ . For reflection uncertainties, it is assumed that  $S_{21} = S_{12} = 0$ . All calibrations and measurements were performed at 0 dBm or default port power, whichever is less. For other conditions, please use our free Exact Uncertainty Calculator software, available for download from the Anritsu web site at [www.anritsu.com](http://www.anritsu.com).

Transmission Magnitude Uncertainty; MS4642B (Opt. 61/62); SOLTSL Calibration using 3652A -1 K kit

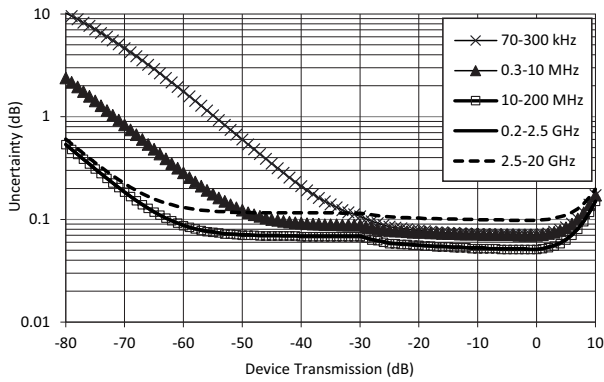

Transmission Phase Uncertainty; MS4642B (Opt. 61/62); SOLT- SL Calibration using 3652A -1 K kit

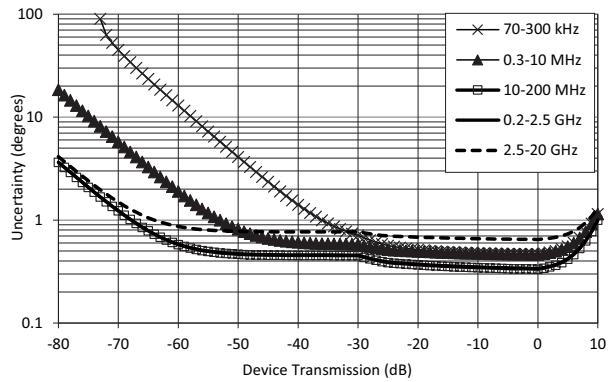

Reflection Magnitude Uncertainty; MS4642B (Opt. 61/62); SOLT-SL Calibration using 3652A-1 K Cal Kit

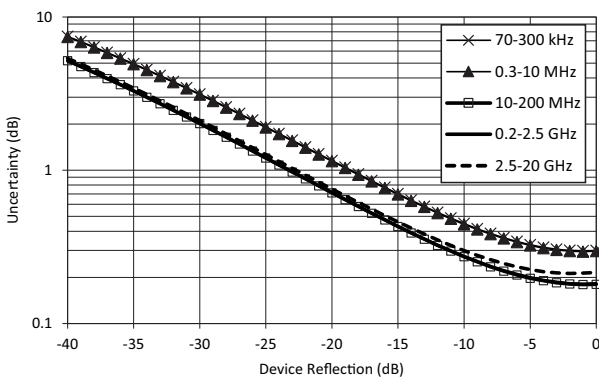

Reflection Phase Uncertainty; MS4642B (Opt. 61/62); SOLT-SL Calibration using 3652A-1 K Cal Kit

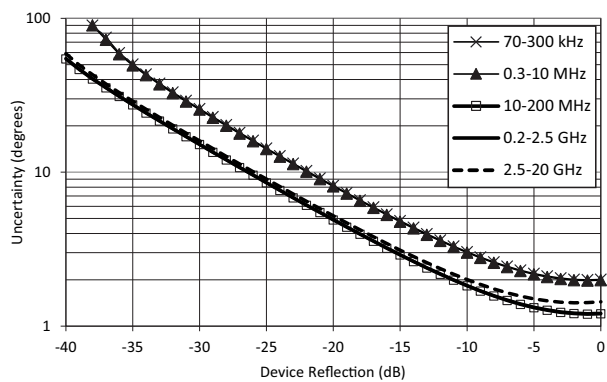

**MS4642B – 12-Term SOLT – 3652A or 3652A-1 K Calibration Kit**

MS4642B 20 GHz Model, with 12-term SOLT Calibration, using 3652A K or 3652A-1 K Cal Kit.

Frequency Range (GHz)	Directivity (dB)	Source Match (dB)	Load Match <sup>a</sup> (dB)	Reflection Tracking (dB)	Transmission Tracking (dB)
70 kHz to 0.01	> 38	> 36	> 38	± 0.02	± 0.05
> 0.01 to < 2.5	> 37	> 41	> 37	± 0.005	± 0.03
2.5 to 20	> 34	> 39	> 35	± 0.006	± 0.07

a. Since Residual Load Match is limited by Residual Directivity and the user test port cable, it can only be specified as Residual Directivity. For practical considerations, derate it by approximately 8 dB for a 3670 Series test port cable, to compensate for effects such as match, repeatability, bend radius, and similar parameters.

**MS4642B Measurement Uncertainties**

The graphs give measurement uncertainties after the above calibration. The errors are a worst-case contribution of residual directivity, load and source match, frequency response and isolation, network analyzer dynamic accuracy, and connector repeatability. 10 Hz IF Bandwidth is used. For transmission uncertainties, it is assumed that  $S_{11} = S_{22} = 0$ . For reflection uncertainties, it is assumed that  $S_{21} = S_{12} = 0$ . All calibrations and measurements were performed at 0 dBm or default port power, whichever is less. For other conditions, please use our free Exact Uncertainty Calculator software, available for download from the Anritsu web site at [www.anritsu.com](http://www.anritsu.com).

Transmission Magnitude Uncertainty; MS4642B (Opt. 61/62); SOLT Calibration using 3652A K Cal Kit

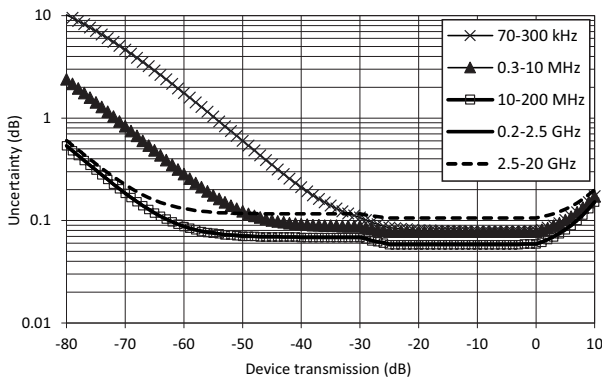

Transmission Phase Uncertainty; MS4642B (Opt. 61/62); SOLT Calibration using 3652A K Cal Kit

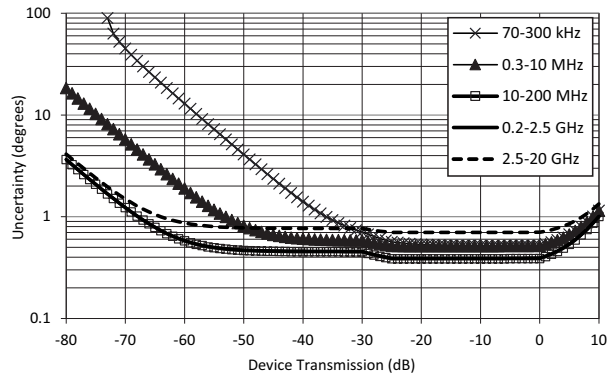

Reflection Magnitude Uncertainty; MS4642B (Opt. 61/62); SOLT Calibration using 3652A K Cal Kit

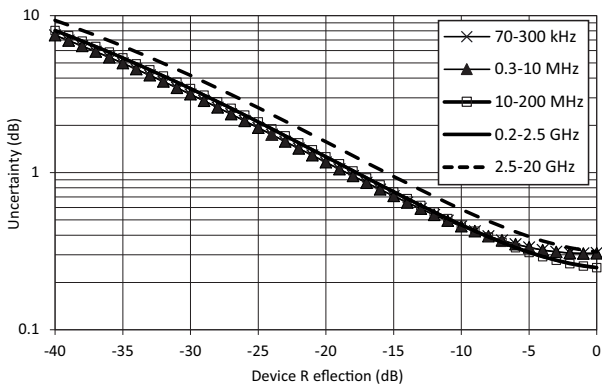

Reflection Phase Uncertainty; MS4642B (Opt. 61/62); SOLT Calibration using 3652A K Cal Kit

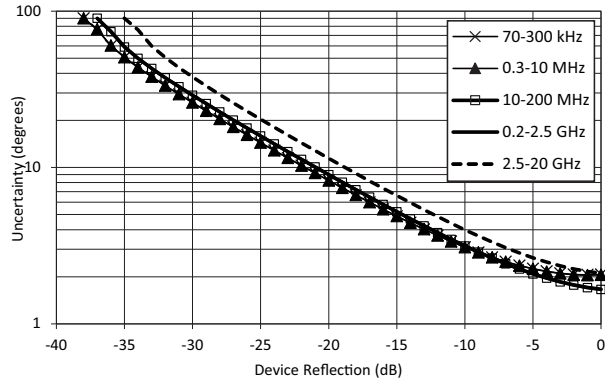

**MS4642B with .s1p Calibration and 3652A-3 or 3652A-4 K Calibration Kit**

MS4642B 20 GHz Model, with .s1p Calibration, using the 3652A-3 or 3652A-4 K Calibration Kit.

Frequency Range (GHz) <sup>a</sup>	Directivity (dB)	Source Match (dB)	Load Match <sup>b</sup> (dB)	Reflection Tracking (dB)	Transmission Tracking (dB)
< 0.01	> 47	> 45	> 46	± 0.02	± 0.05
0.01 to < 2.5	> 47	> 45	> 46	± 0.005	± 0.03
2.5 to 20	> 46	> 45	> 46	± 0.006	± 0.07

- a. The performance levels for the s1p calibration processes are contingent on the pin depth of the connector at the reference plane (and of any DUT connector) meeting Anritsu specifications.
- b. Since Residual Load Match is limited by Residual Directivity and the user test port cable, it can only be specified at Residual Directivity. For practical considerations, derate it by approximately 8 dB for a 3670 series test port cable, to compensate for effects such as match, repeatability, bend radius, and similar parameters.

**MS4642B Measurement Uncertainties**

The graphs give measurement uncertainties after the above calibration. The errors are a worst-case contribution of residual directivity, load and source match, frequency response and isolation, network analyzer dynamic accuracy, and connector repeatability. 10 Hz IF Bandwidth is used. For transmission uncertainties, it is assumed that  $S_{11} = S_{22} = 0$ . For reflection uncertainties, it is assumed that  $S_{21} = S_{12} = 0$ . All calibrations and measurements were performed at 0 dBm or default port power, whichever is less. Graphs calculated not using Options 51, 61, or 62. Those options affect noise floor and will shift the low transmission uncertainties accordingly. For other conditions, please use our free Exact Uncertainty Calculator software, available for download from the Anritsu web site at [www.anritsu.com](http://www.anritsu.com).

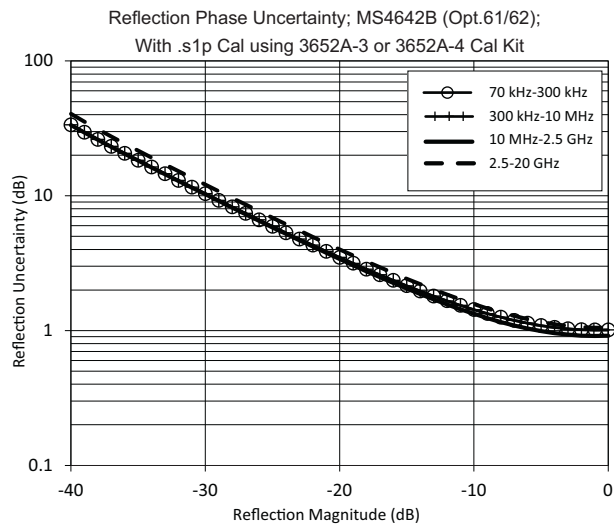
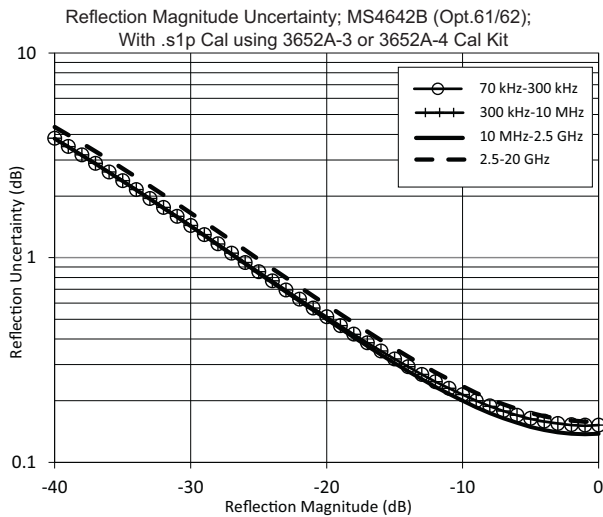
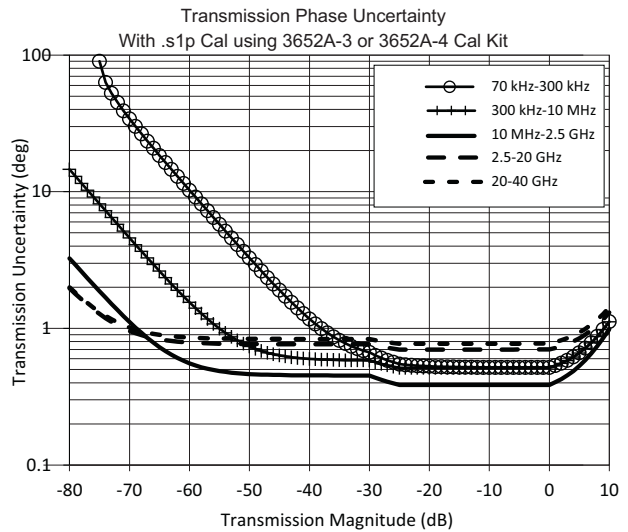
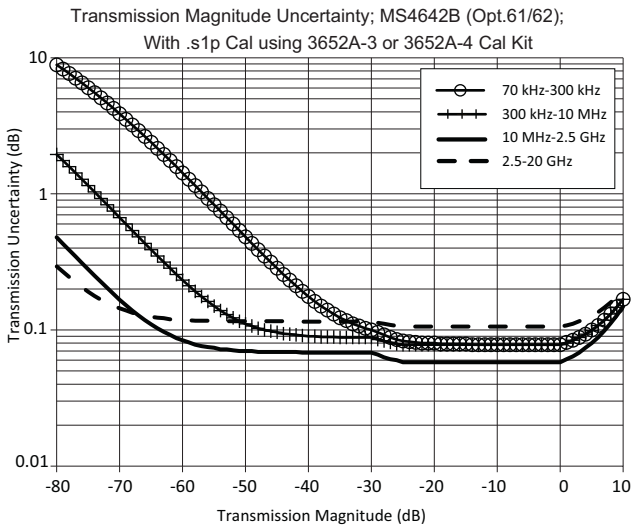



**MS4642B - 12-Term SOLT - Sliding Load - 3650A-1 3.5 mm Calibration Kit**

MS4642B 20 GHz Model, with 12-term SOLT Calibration with Sliding Load Calibration, using the 3650A-1 3.5 mm Cal Kit.

Frequency Range (GHz)	Directivity (dB)	Source Match (dB)	Load Match <sup>a</sup> (dB)	Reflection Tracking (dB)	Transmission Tracking (dB)
70 kHz to 0.01	> 40	> 37	> 40	± 0.02	± 0.05
> 0.01 to < 2.5	> 42	> 41	> 42	± 0.005	± 0.03
2.5 to 10	> 43	> 39	> 43	± 0.005	± 0.03
> 10 to 20	> 43	> 39	> 43	± 0.006	± 0.07

a. Since Residual Load Match is limited by Residual Directivity and the user test port cable, it can only be specified as Residual Directivity. For practical considerations, derate it by approximately 8 dB for a 3670 series test port cable, to compensate for effects such as match, repeatability, bend radius, and similar parameters.

**MS4642B Measurement Uncertainties**

The graphs give measurement uncertainties after the above calibration. The errors are a worst-case contribution of residual directivity, load and source match, frequency response and isolation, network analyzer dynamic accuracy, and connector repeatability. 10 Hz IF Bandwidth is used. For transmission uncertainties, it is assumed that  $S_{11} = S_{22} = 0$ . For reflection uncertainties, it is assumed that  $S_{21} = S_{12} = 0$ . All calibrations and measurements were performed at 0 dBm or default port power, whichever is less. For other conditions, please use our free Exact Uncertainty Calculator software, available for download from the Anritsu web site at [www.anritsu.com](http://www.anritsu.com).

Transmission Magnitude Uncertainty; MS4642B (Opt. 61/62); SOLT-SL Calibration using 3650A-1 3.5 mm Cal Kit

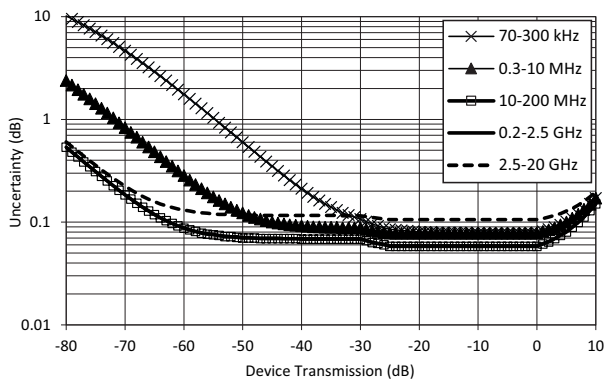

Transmission Phase Uncertainty; MS4642B (Opt. 61/62); SOLT-SL Calibration using 3650A-1 3.5 mm Cal Kit

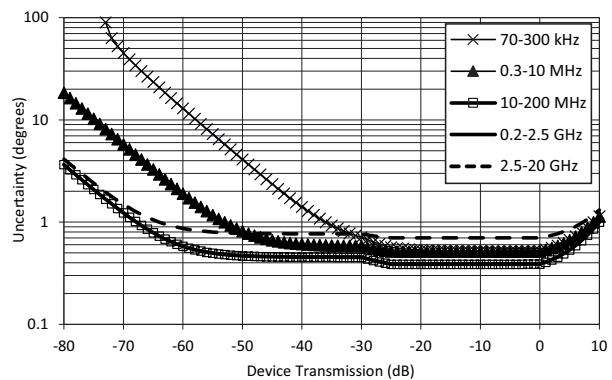

Reflection Magnitude Uncertainty; MS4642B (Opt. 61/62); SOLT-SL Calibration using 3650A-1 3.5 mm Cal Kit

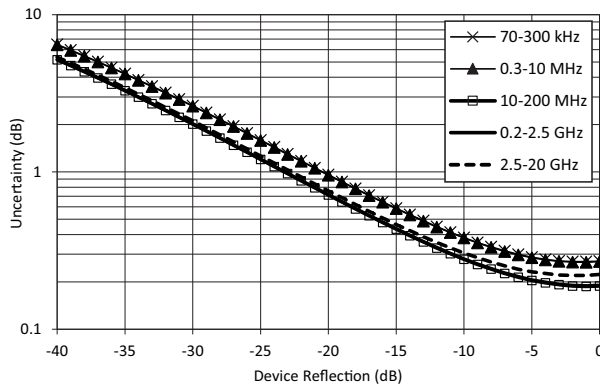

Reflection Phase Uncertainty; MS4642B (Opt. 61/62); SOLT-SL Calibration using 3650A-1 3.5 mm Cal Kit

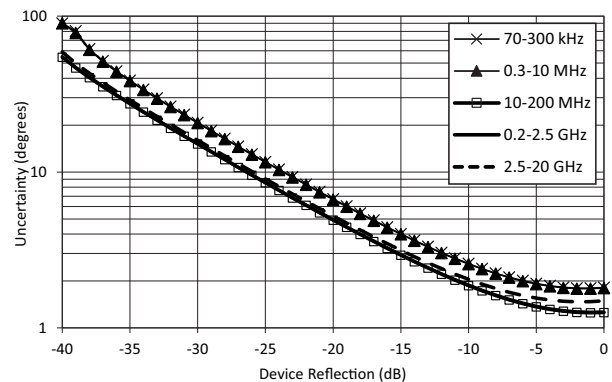

**MS4642B – 12-Term SOLT – 3650A or 3650A-1 3.5 mm Calibration Kit**

MS4642B 20 GHz Model, with 12-term SOLT Calibration, using the 3650A or 3650A-1 3.5 mm Cal Kit.

Frequency Range (GHz)	Directivity (dB)	Source Match (dB)	Load Match <sup>a</sup> (dB)	Reflection Tracking (dB)	Transmission Tracking (dB)
70 kHz to 0.01	> 40	> 37	> 40	± 0.02	± 0.05
> 0.01 to < 2.5	> 42	> 40	> 42	± 0.005	± 0.03
2.5 to 10	> 40	> 34	> 40	± 0.005	± 0.03
> 10 to 20	> 30	> 34	> 30	± 0.006	± 0.07

a. Since Residual Load Match is limited by Residual Directivity and the user test port cable, it can only be specified as Residual Directivity. For practical considerations, derate it by approximately 8 dB for a 3670 Series test port cable, to compensate for effects such as match, repeatability, bend radius, and similar parameters.

**MS4642B Measurement Uncertainties**

The graphs give measurement uncertainties after the above calibration. The errors are a worst-case contribution of residual directivity, load and source match, frequency response and isolation, network analyzer dynamic accuracy, and connector repeatability. 10 Hz IF Bandwidth is used. For transmission uncertainties, it is assumed that  $S_{11} = S_{22} = 0$ . For reflection uncertainties, it is assumed that  $S_{21} = S_{12} = 0$ . All calibrations and measurements were performed at 0 dBm or default port power, whichever is less. For other conditions, please use our free Exact Uncertainty Calculator software, available for download from the Anritsu web site at [www.anritsu.com](http://www.anritsu.com).

Transmission Magnitude Uncertainty; MS4642B (Opt. 61/62); SOLT Calibration using 3650A 3.5 mm Cal Kit

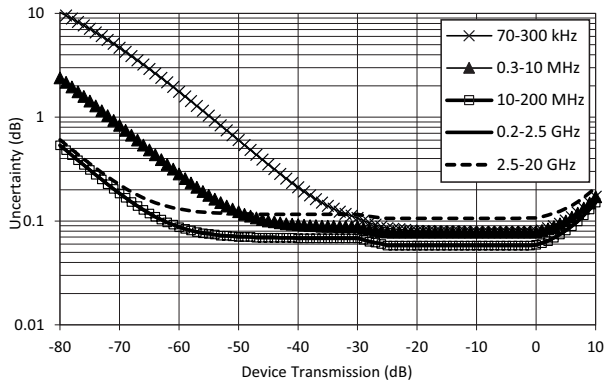

Transmission Phase Uncertainty; MS4642B (Opt. 61/62); SOLT Calibration using 3650A 3.5 mm Cal Kit

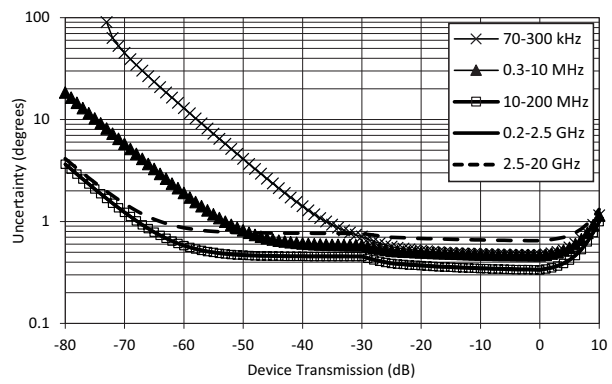

Reflection Magnitude Uncertainty; MS4642B (Opt. 16/62); SOLT Calibration using 3650A 3.5mm Cal Kit

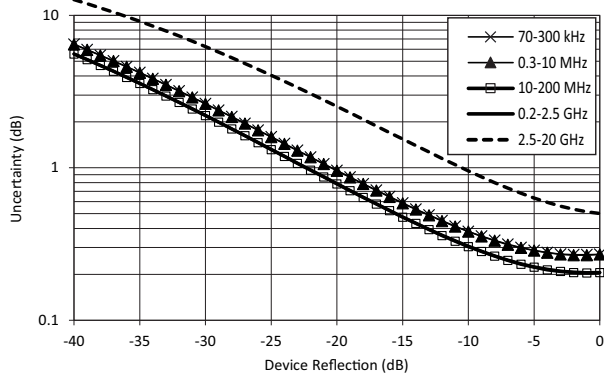

Reflection Phase Uncertainty; MS4642B (Opt. 61/62); SOLT Calibration using 3650A 3.5 mm Cal Kit

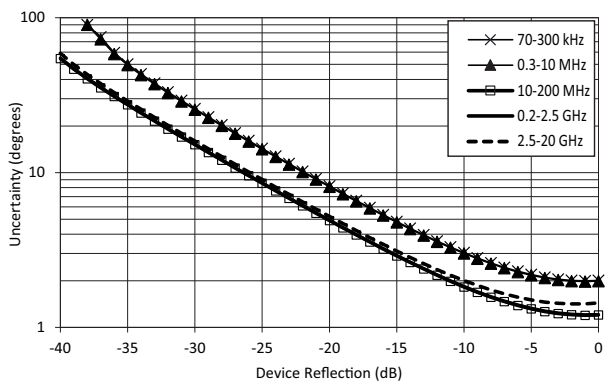

**MS4642B – 12-Term – 36585K K AutoCal™**

MS4642B 20 GHz Model, with 12-term Calibration, using the 36585K K Automatic Calibrator (AutoCal)

Frequency Range (GHz)	Directivity (dB)	Source Match (dB)	Load Match <sup>a</sup> (dB)	Reflection Tracking (dB)	Transmission Tracking (dB)
70 kHz to 0.01 <sup>b</sup>	> 40	> 40	> 43	± 0.10	± 0.10
> 0.01 to < 2.5	> 43	> 47	> 43	± 0.05	± 0.03
2.5 to 20	> 50	> 47	> 50	± 0.09	± 0.03

a. Since Residual Load Match is limited by Residual Directivity and the user test port cable, it can only be specified as Residual Directivity. For practical considerations, derate it by approximately 8 dB for a 3670 series test port cable, to compensate for effects such as match, repeatability, bend radius, and similar parameters.

b. Typical performance below 2 MHz.

**MS4642B Measurement Uncertainties**

The graphs give measurement uncertainties after the above calibration. The errors are a worst-case contribution of residual directivity, load and source match, frequency response and isolation, network analyzer dynamic accuracy, and connector repeatability. 10 Hz IF Bandwidth is used. For transmission uncertainties, it is assumed that  $S_{21} = S_{12} = 0$ . For reflection uncertainties, it is assumed that  $S_{11} = S_{22} = 0$ . All calibrations and measurements were performed at 0 dBm or default port power, whichever is less. For other conditions, please use our free Exact Uncertainty Calculator software, available for download from the Anritsu web site at [www.anritsu.com](http://www.anritsu.com).

Transmission Magnitude Uncertainty; MS4642B (Opt. 61/62);  
12-term Calibration using 36585K AutoCal

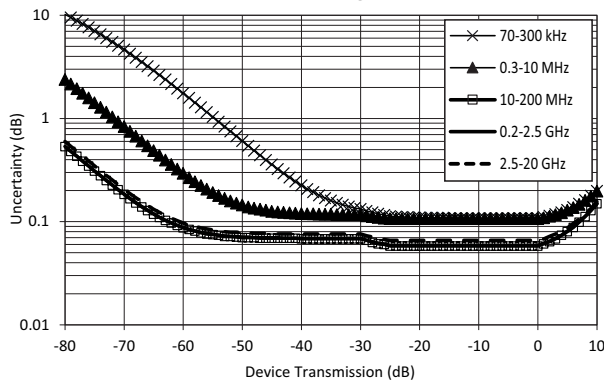

Transmission Phase Uncertainty; MS4642B (Opt. 61/62);  
12-term Calibration using 36585K AutoCal

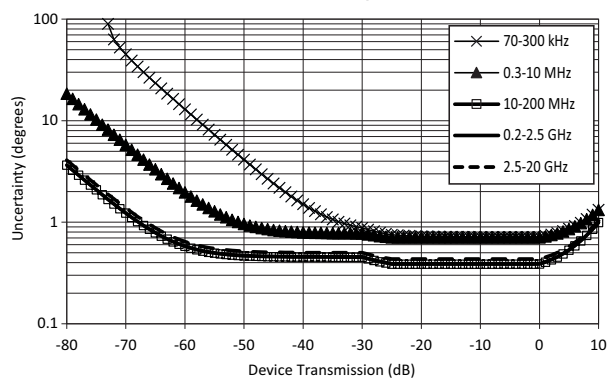

Reflection Magnitude Uncertainty; MS4642B (Opt. 61/62);  
12-term Calibration using 36585K AutoCal

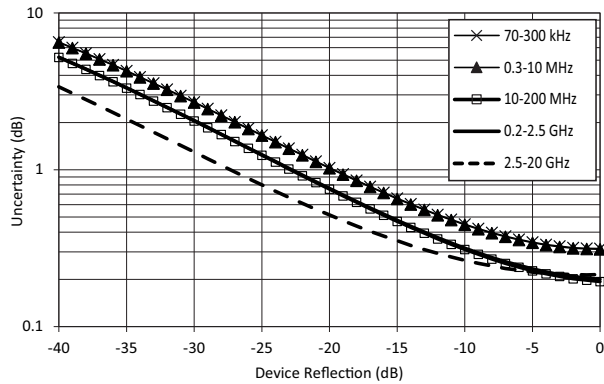

Reflection Phase Uncertainty; MS4642B (Opt. 61/62);  
12-term Calibration using 36585K AutoCal

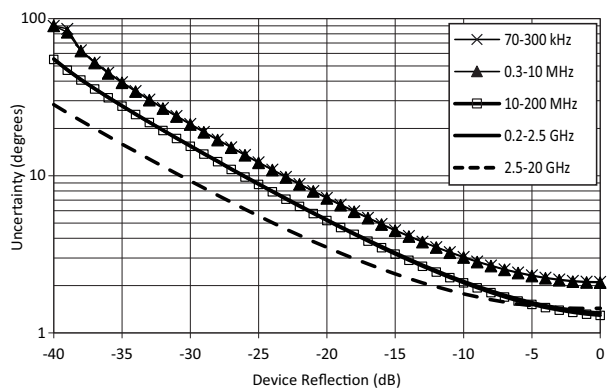

MS4644B 40 GHz VNA System Performance

MS4644B – 12-Term SOLT – Sliding Load – 3652A-1 K Calibration Kit

MS4644B 40 GHz Model, with 12-term SOLT with Sliding Load Calibration, using the 3652A-1 K Calibration Kit.

Frequency Range (GHz)	Directivity (dB)	Source Match (dB)	Load Match <sup>a</sup> (dB)	Reflection Tracking (dB)	Transmission Tracking (dB)
70 kHz to 0.01	> 38	> 36	> 38	± 0.02	± 0.05
> 0.01 to < 2.5	> 42	> 41	> 42	± 0.005	± 0.03
2.5 to 20	> 43	> 39	> 43	± 0.006	± 0.07
> 20 to 40	> 40	> 34	> 40	± 0.006	± 0.08

a. Since Residual Load Match is limited by Residual Directivity and the user test port cable, it can only be specified at Residual Directivity. For practical considerations, derate it by approximately 8 dB for a 3670 series test port cable, to compensate for effects such as match, repeatability, bend radius, and similar parameters.

MS4644B Measurement Uncertainties

The graphs give measurement uncertainties after the above calibration. The errors are a worst-case contribution of residual directivity, load and source match, frequency response and isolation, network analyzer dynamic accuracy, and connector repeatability. 10 Hz IF Bandwidth is used. For transmission uncertainties, it is assumed that  $S_{11} = S_{22} = 0$ . For reflection uncertainties, it is assumed that  $S_{21} = S_{12} = 0$ . All calibrations and measurements were performed at 0 dBm or default port power, whichever is less. Graphs calculated not using Options 51, 61, or 62. Those options affect noise floor and will shift the low transmission uncertainties accordingly. For other conditions, please use our free Exact Uncertainty Calculator software, available for download from the Anritsu web site at [www.anritsu.com](http://www.anritsu.com).

Transmission Magnitude Uncertainty  
MS4644B with SOLT-SL Calibration using 3652A-1 Cal Kit

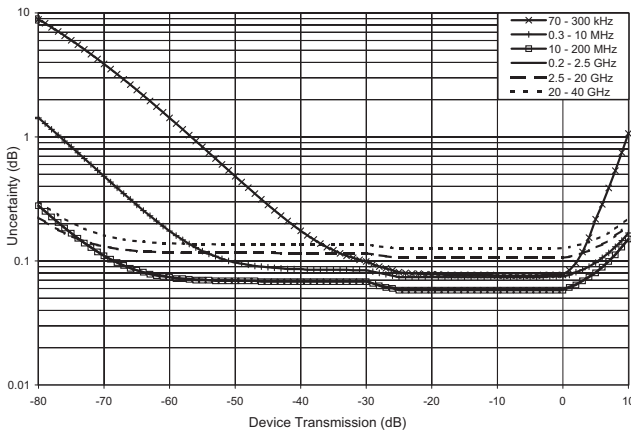

Transmission Phase Uncertainty  
MS4644B with SOLT-SL Calibration using 3652A-1 Cal Kit

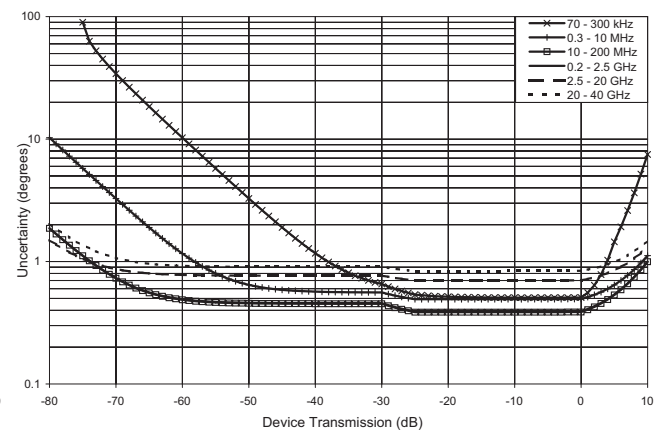

Reflection Magnitude Uncertainty  
MS4644B with SOLT-SL Calibration using 3652A-1 Cal Kit

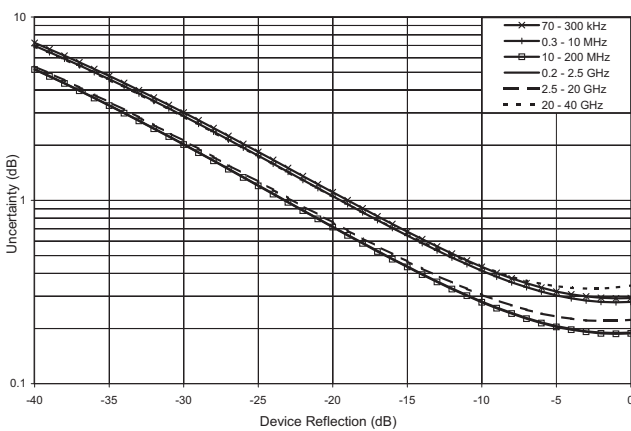

Reflection Phase Uncertainty  
MS4644B with SOLT-SL Calibration using 3652A-1 Cal Kit

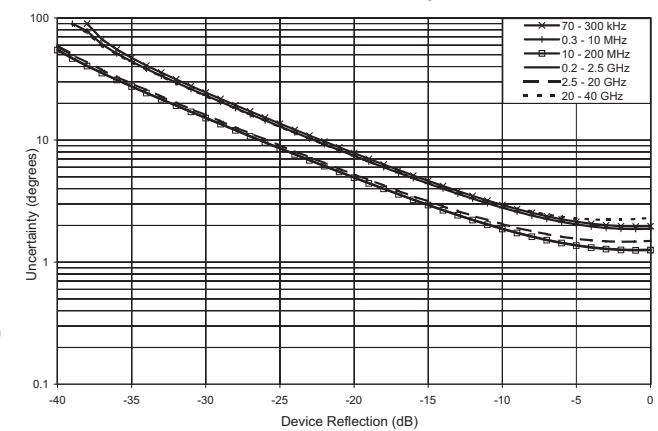

**MS4644B – 12-Term SOLT – 3652A or 3652A-1 K Calibration Kit**

MS4644B 40 GHz Model, with 12-term SOLT Calibration, using the 3652A or 3652A-1 K Calibration Kit.

Frequency Range (GHz)	Directivity (dB)	Source Match (dB)	Load Match <sup>a</sup> (dB)	Reflection Tracking (dB)	Transmission Tracking (dB)
70 kHz to 0.01	> 38	> 36	> 38	± 0.02	± 0.05
> 0.01 to < 2.5	> 37	> 41	> 37	± 0.005	± 0.03
2.5 to 20	> 34	> 39	> 35	± 0.006	± 0.07
> 20 to 40	> 32	> 34	> 32	± 0.006	± 0.08

a. Since Residual Load Match is limited by Residual Directivity and the user test port cable, it can only be specified as Residual Directivity. For practical considerations, derate it by approximately 8 dB for a 3670 series test port cable, to compensate for effects such as match, repeatability, bend radius, and similar parameters.

**MS4644B Measurement Uncertainties**

The graphs give measurement uncertainties after the above calibration. The errors are a worst-case contribution of residual directivity, load and source match, frequency response and isolation, network analyzer dynamic accuracy, and connector repeatability. 10 Hz IF Bandwidth is used. For transmission uncertainties, it is assumed that  $S_{11} = S_{22} = 0$ . For reflection uncertainties, it is assumed that  $S_{21} = S_{12} = 0$ . All calibrations and measurements were performed at 0 dBm or default port power, whichever is less. Graphs calculated not using Options 51, 61, or 62. Those options affect noise floor and will shift the low transmission uncertainties accordingly. For other conditions, please use our free Exact Uncertainty Calculator software, available for download from the Anritsu web site at [www.anritsu.com](http://www.anritsu.com).

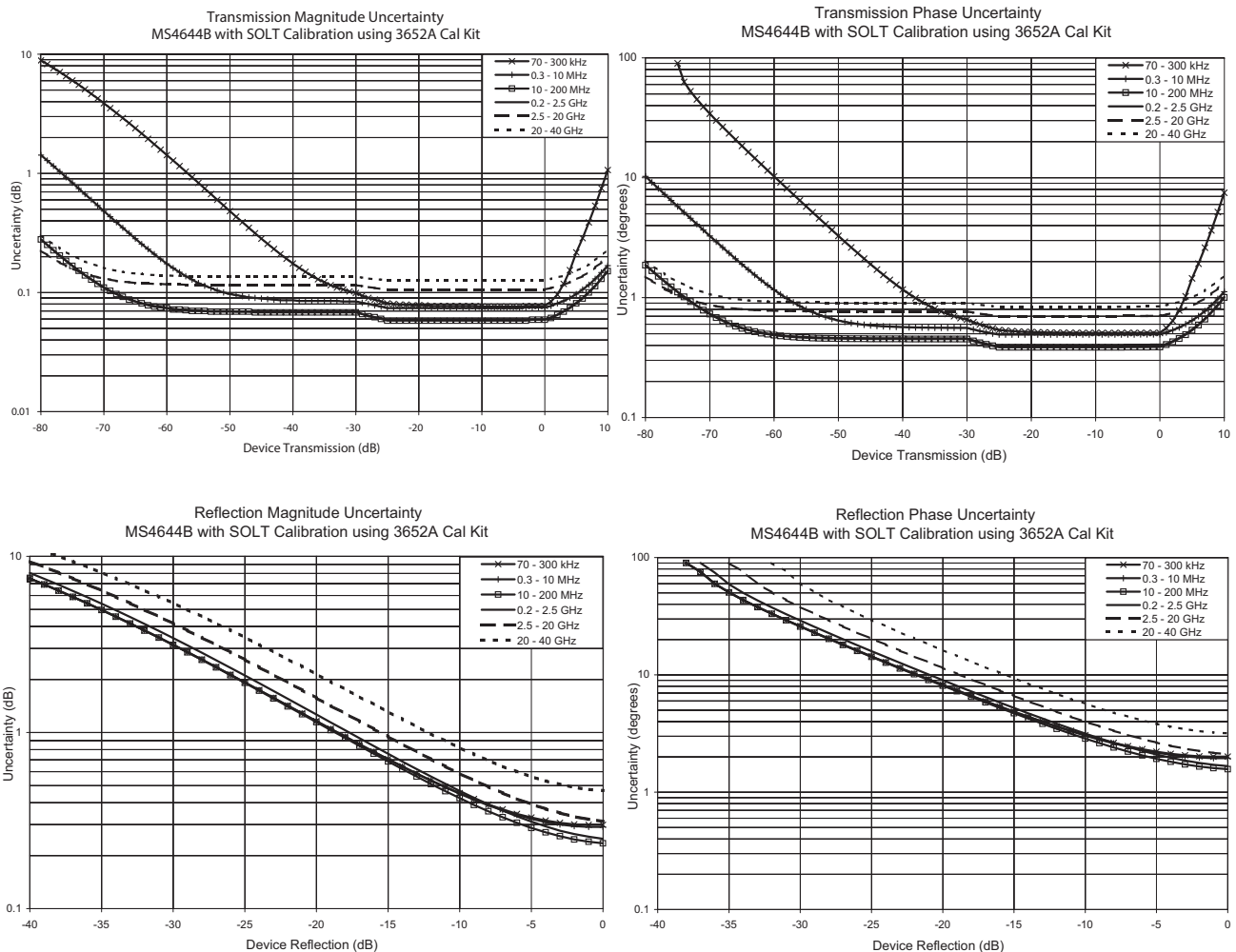

**MS4644B with .s1p Calibration and 3652A-3 or 3652A-4 K Calibration Kit**

MS4644B 40 GHz Model, with .s1p Calibration, using the 3652A-3 or 3652A-4 K Calibration Kit.

Frequency Range (GHz) <sup>a</sup>	Directivity (dB)	Source Match (dB)	Load Match <sup>b</sup> (dB)	Reflection Tracking (dB)	Transmission Tracking (dB)
< 0.01	> 47	> 45	> 46	± 0.02	± 0.05
0.01 to < 2.5	> 47	> 45	> 46	± 0.005	± 0.03
2.5 to 20	> 46	> 45	> 46	± 0.006	± 0.07
> 20 to 40	> 42	> 38	> 42	± 0.006	± 0.07

- a. The performance levels for the .s1p calibration processes are contingent on the pin depth of the connector at the reference plane (and of any DUT connector) meeting Anritsu specifications.
- b. Since Residual Load Match is limited by Residual Directivity and the user test port cable, it can only be specified at Residual Directivity. For practical considerations, derate it by approximately 8 dB for a 3670 series test port cable, to compensate for effects such as match, repeatability, bend radius, and similar parameters.

**MS4644B Measurement Uncertainties**

The graphs give measurement uncertainties after the above calibration. The errors are a worst-case contribution of residual directivity, load and source match, frequency response and isolation, network analyzer dynamic accuracy, and connector repeatability. 10 Hz IF Bandwidth is used. For transmission uncertainties, it is assumed that  $S_{11} = S_{22} = 0$ . For reflection uncertainties, it is assumed that  $S_{21} = S_{12} = 0$ . All calibrations and measurements were performed at 0 dBm or default port power, whichever is less. Graphs calculated not using Options 51, 61, or 62. Those options affect noise floor and will shift the low transmission uncertainties accordingly. For other conditions, please use our free Exact Uncertainty Calculator software, available for download from the Anritsu web site at [www.anritsu.com](http://www.anritsu.com).

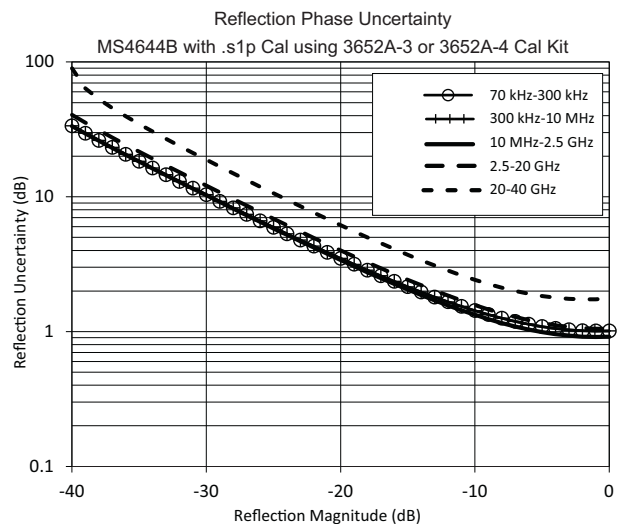
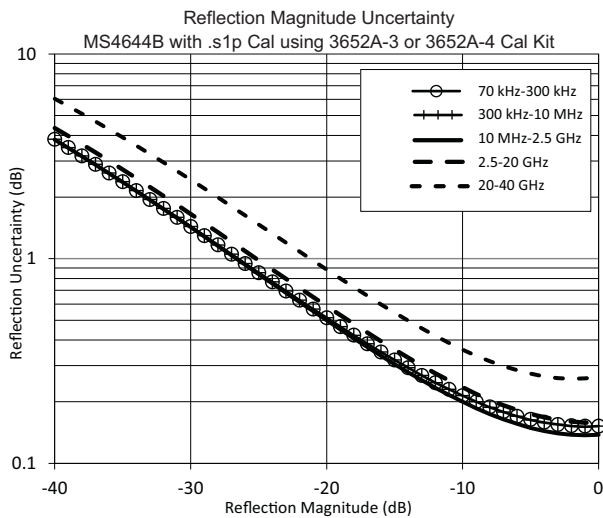
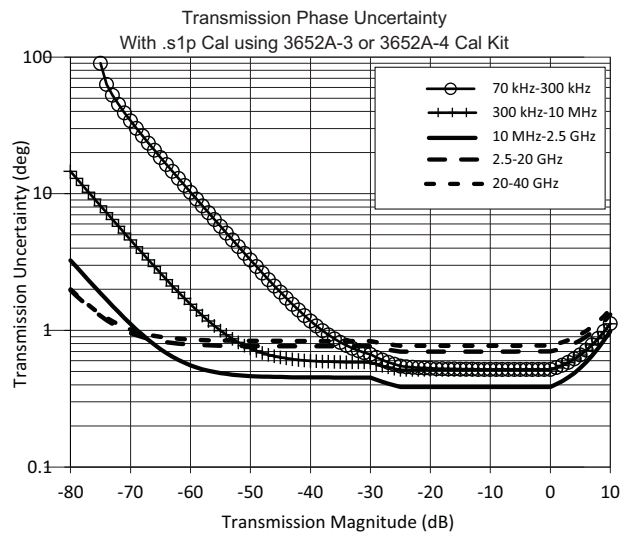
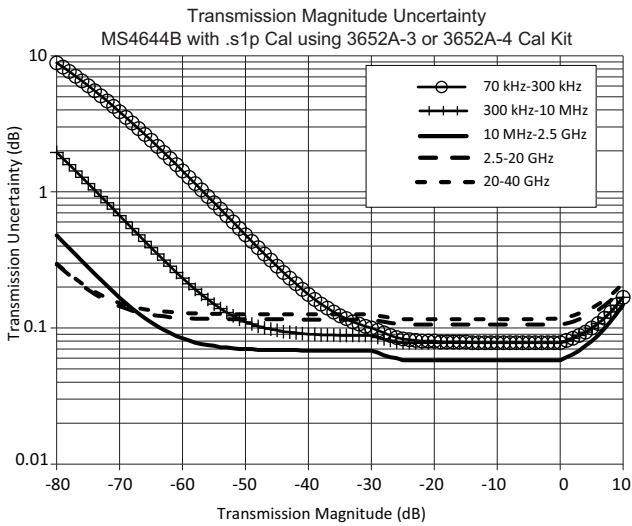

**MS4644B – 12-Term – 36585K K AutoCal**

MS4644B 40 GHz Model, with 12-term Calibration, using the 36585K K AutoCal.

Frequency Range (GHz)	Directivity (dB)	Source Match (dB)	Load Match <sup>a</sup> (dB)	Reflection Tracking (dB)	Transmission Tracking (dB)
70 kHz to 0.01 <sup>b</sup>	> 40	> 40	> 43	± 0.10	± 0.10
> 0.01 to < 2.5	> 43	> 47	> 43	± 0.05	± 0.03
2.5 to 20	> 50	> 47	> 50	± 0.09	± 0.03
> 20 to 40	> 48	> 47	> 48	± 0.14	± 0.07

- a. Since Residual Load Match is limited by Residual Directivity and the user test port cable, it can only be specified as Residual Directivity. For practical considerations, derate it by approximately 8 dB for a 3670 Series test port cable, to compensate for effects such as match, repeatability, bend radius, and similar parameters.
- b. Typical performance below 2 MHz.

**MS4644B Measurement Uncertainties**

The graphs give measurement uncertainties after the above calibration. The errors are a worst-case contribution of residual directivity, load and source match, frequency response and isolation, network analyzer dynamic accuracy, and connector repeatability. 10 Hz IF Bandwidth is used. For transmission uncertainties, it is assumed that  $S_{11} = S_{22} = 0$ . For reflection uncertainties, it is assumed that  $S_{21} = S_{12} = 0$ . All calibrations and measurements were performed at 0 dBm or default port power, whichever is less. Graphs calculated not using Options 51, 61, or 62. Those options affect noise floor and will shift the low transmission uncertainties accordingly. For other conditions, please use our free Exact Uncertainty Calculator software, available for download from the Anritsu web site at [www.anritsu.com](http://www.anritsu.com).

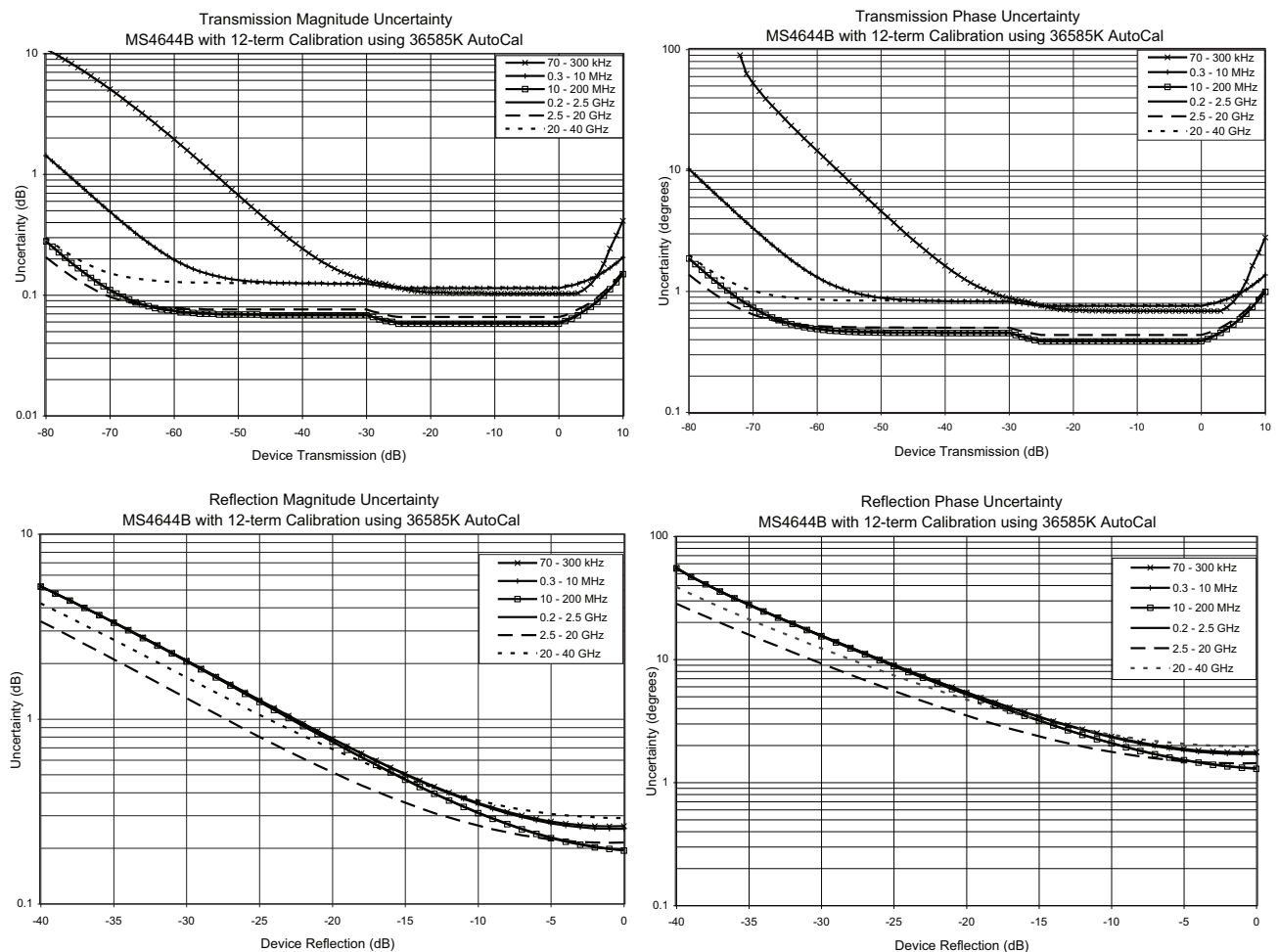

MS4647B 70 GHz VNA System Performance

MS4647B VNA - 12-Term SOLT Sliding Load - 3654D-1 V Calibration Kit

Frequency Range (GHz)	Directivity (dB)	Source Match (dB)	Load Match <sup>a</sup> (dB)	Reflection Tracking (dB)	Transmission Tracking (dB)
70 kHz to 0.01	> 38	> 36	> 38	± 0.02	± 0.05
> 0.01 to < 2.5	> 41	> 39	> 41	± 0.02	± 0.05
2.5 to 20	> 41	> 37	> 41	± 0.02	± 0.07
> 20 to 40	> 37	> 32	> 37	± 0.02	± 0.08
> 40 to 65	> 35	> 28	> 35	± 0.08	± 0.12
> 65 to 67	> 35	> 28	> 35	± 0.15	± 0.15
> 67 to 70	> 30	> 26	> 30	± 0.30	± 0.15

a. Since Residual Load Match is limited by Residual Directivity and the user test port cable, it can only be specified as Residual Directivity. For practical considerations, derate it by approximately 8 dB for a 3670 series test port cable, to compensate for effects such as match, repeatability, bend radius, and similar parameters.

MS4647B Measurement Uncertainties (Transmission)

The graphs give measurement uncertainties after the above calibration. The errors are a worst-case contribution of residual directivity, load and source match, frequency response and isolation, network analyzer dynamic accuracy, and connector repeatability. 10 Hz IF Bandwidth is used. For transmission uncertainties, it is assumed that  $S_{11} = S_{22} = 0$ . For reflection uncertainties, it is assumed that  $S_{21} = S_{12} = 0$ . All calibrations and measurements were performed at 0 dBm or default port power, whichever is less. Graphs calculated not using Options 51, 61, or 62. Those options affect noise floor and will shift the low transmission uncertainties accordingly. For other conditions, please use our free Exact Uncertainty Calculator software, available for download from the Anritsu web site at [www.anritsu.com](http://www.anritsu.com).

Transmission Magnitude Uncertainty (1 of 2)  
MS4647B with SOLT-SL Calibration using 3654D-1 Cal Kit

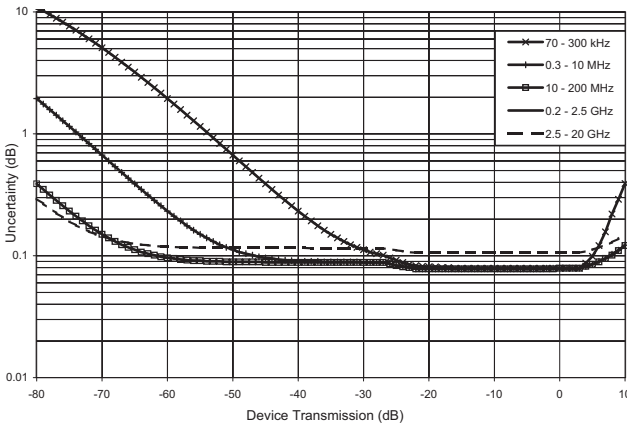

Transmission Magnitude Uncertainty (2 of 2)  
MS4647B with SOLT-SL Calibration using 3654D-1 Cal Kit

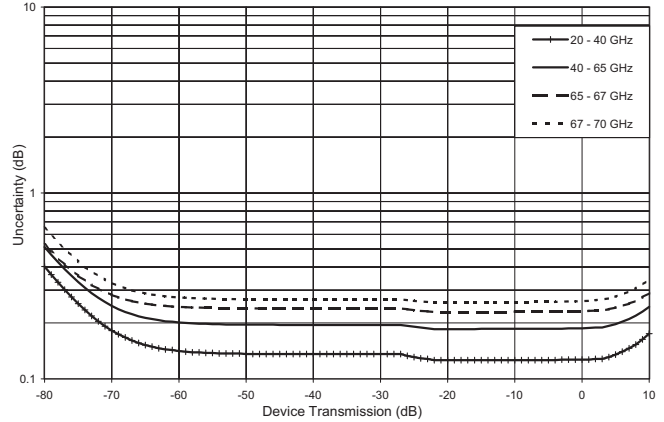

Transmission Phase Uncertainty (1 of 2)  
MS4647B with SOLT-SL Calibration using 3654D-1 Cal Kit

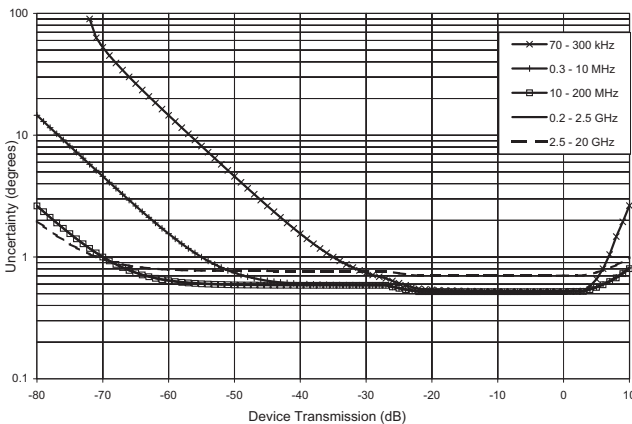

Transmission Phase Uncertainty (2 of 2)  
MS4647B with SOLT-SL Calibration using 3654D-1 Cal Kit

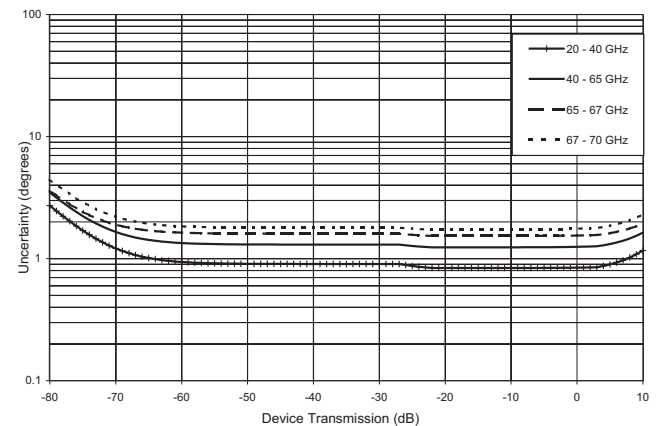



**MS4647B Measurement Uncertainties (Reflection)**

The graphs give measurement uncertainties after the above calibration. The errors are a worst-case contribution of residual directivity, load and source match, frequency response and isolation, network analyzer dynamic accuracy, and connector repeatability. 10 Hz IF Bandwidth is used. For transmission uncertainties, it is assumed that  $S_{11} = S_{22} = 0$ . For reflection uncertainties, it is assumed that  $S_{21} = S_{12} = 0$ . All calibrations and measurements were performed at 0 dBm or default port power, whichever is less. Graphs calculated not using Options 51, 61, or 62. Those options affect noise floor and will shift the low transmission uncertainties accordingly. For other conditions, please use our free Exact Uncertainty Calculator software, available for download from the Anritsu web site at [www.anritsu.com](http://www.anritsu.com).

Reflection Magnitude Uncertainty (1 of 2)  
MS4647B with SOLT-SL Cal with 3654D-1 Cal Kit

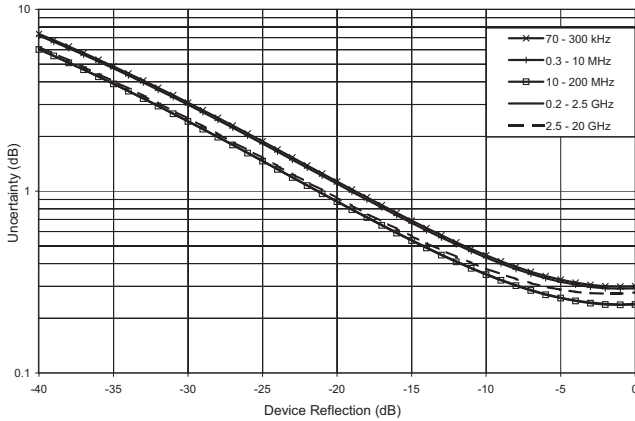

Reflection Magnitude Uncertainty (2 of 2)  
MS4647B with SOLT-SL Cal with 3654D-1 Cal Kit

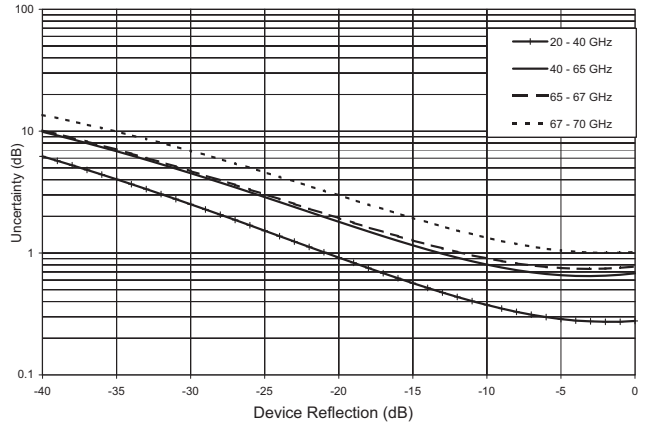

Reflection Phase Uncertainty (1 of 2)  
MS4647B with SOLT-SL Cal with 3654D-1 Cal Kit

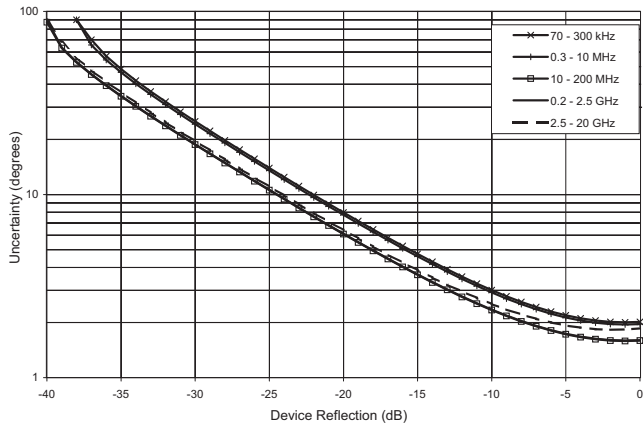

Reflection Phase Uncertainty (2 of 2)  
MS4647B with SOLT-SL Cal with 3654D-1 Cal Kit

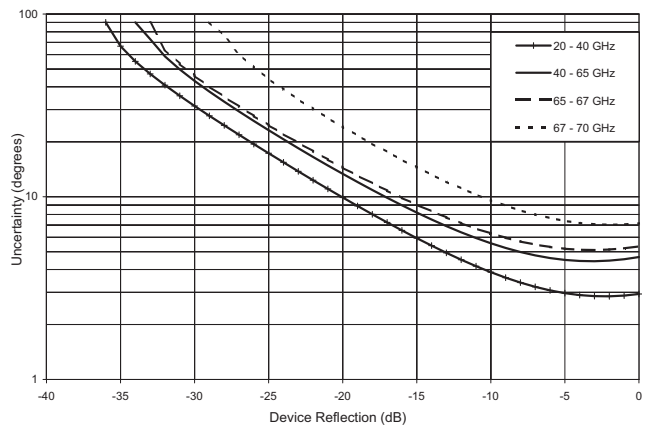

**MS4647B VNA – 12-Term SOLT – 3654D or 3654D-1 V Calibration Kit**

Frequency Range (GHz)	Directivity (dB)	Source Match (dB)	Load Match <sup>a</sup> (dB)	Reflection Tracking (dB)	Transmission Tracking (dB)
70 kHz to 0.01	> 38	> 36	> 38	± 0.02	± 0.05
> 0.01 to < 2.5	> 40	> 39	> 40	± 0.02	± 0.05
2.5 to 20	> 40	> 37	> 40	± 0.02	± 0.07
> 20 to 40	> 35	> 32	> 35	± 0.02	± 0.08
> 40 to 65	> 32	> 28	> 32	± 0.08	± 0.12
> 65 to 67	> 32	> 28	> 32	± 0.15	± 0.15
> 67 to 70	> 28	> 26	> 28	± 0.30	± 0.15

a. Since Residual Load Match is limited by Residual Directivity and the user test port cable, it can only be specified as Residual Directivity. For practical considerations, derate it by approximately 8 dB for a 3670 series test port cable, to compensate for effects such as match, repeatability, bend radius, and similar parameters.

**MS4647B Measurement Uncertainties (Transmission)**

The graphs give measurement uncertainties after the above calibration. The errors are a worst-case contribution of residual directivity, load and source match, frequency response and isolation, network analyzer dynamic accuracy, and connector repeatability. 10 Hz IF Bandwidth is used. For transmission uncertainties, it is assumed that  $S_{11} = S_{22} = 0$ . For reflection uncertainties, it is assumed that  $S_{21} = S_{12} = 0$ . All calibrations and measurements were performed at 0 dBm or default port power, whichever is less. Graphs calculated not using Options 51, 61, or 62. Those options affect noise floor and will shift the low transmission uncertainties accordingly. For other conditions, please use our free Exact Uncertainty Calculator software, available for download from the Anritsu web site at [www.anritsu.com](http://www.anritsu.com).

Transmission Magnitude Uncertainty (1 of 2)  
MS4647B with SOLT Calibration using 3654D Cal Kit

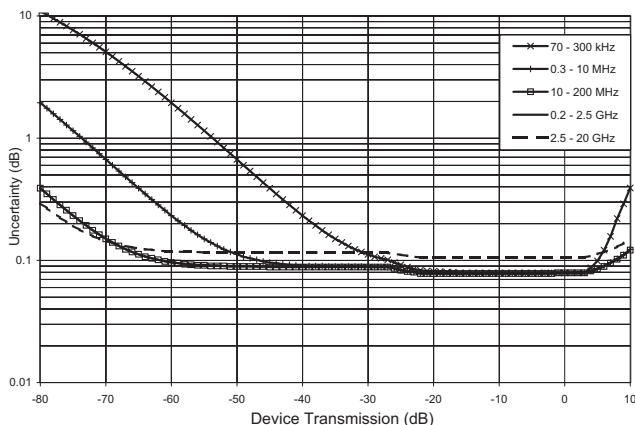

Transmission Magnitude Uncertainty (2 of 2)  
MS4647B with SOLT Calibration using 3654D Cal Kit

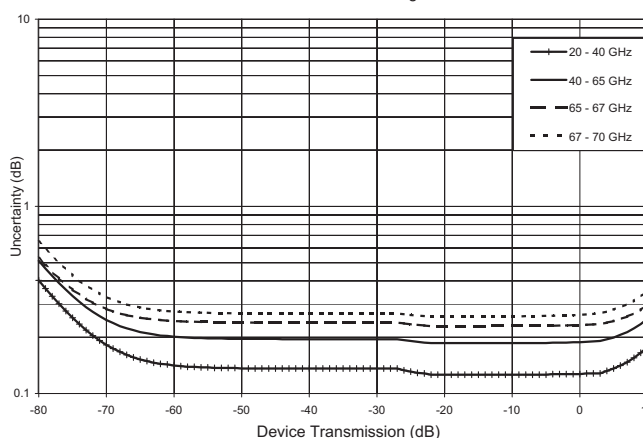

Transmission Phase Uncertainty (1 of 2)  
MS4647B with SOLT Calibration using 3654D Cal Kit

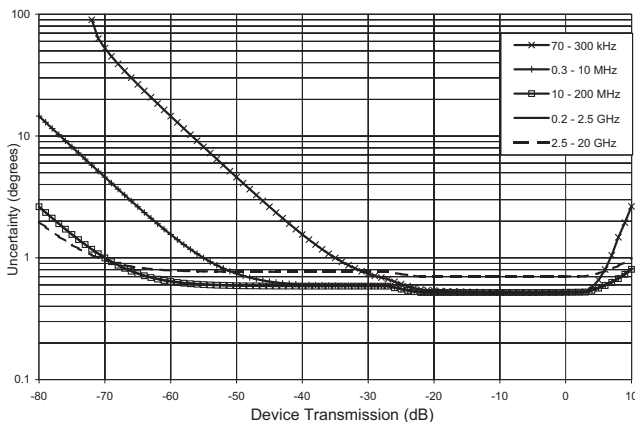

Transmission Phase Uncertainty (2 of 2)  
MS4647B with SOLT Calibration using 3654D Cal Kit

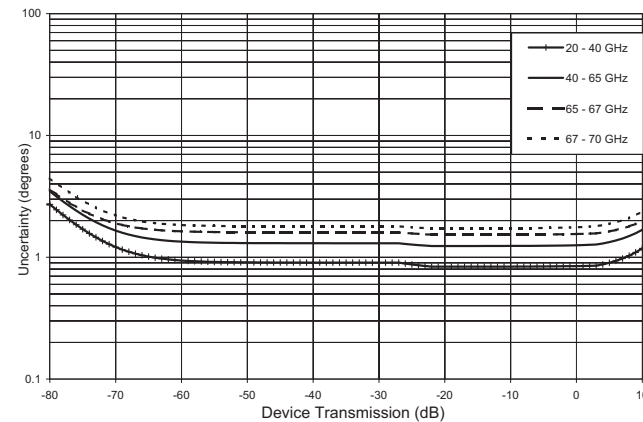

**MS4647B Measurement Uncertainties (Reflection)**

The graphs give measurement uncertainties after the above calibration. The errors are a worst-case contribution of residual directivity, load and source match, frequency response and isolation, network analyzer dynamic accuracy, and connector repeatability. 10 Hz IF Bandwidth is used. For transmission uncertainties, it is assumed that  $S_{11} = S_{22} = 0$ . For reflection uncertainties, it is assumed that  $S_{21} = S_{12} = 0$ . All calibrations and measurements were performed at 0 dBm or default port power, whichever is less. Graphs calculated not using Options 51, 61, or 62. Those options affect noise floor and will shift the low transmission uncertainties accordingly. For other conditions, please use our free Exact Uncertainty Calculator software, available for download from the Anritsu web site at [www.anritsu.com](http://www.anritsu.com).

Reflection Magnitude Uncertainty (1 of 2)  
MS4647B with SOLT Calibration using 3654D Cal Kit

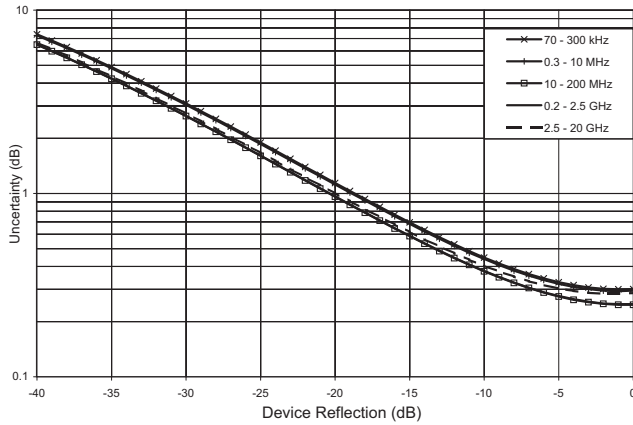

Reflection Magnitude Uncertainty (2 of 2)  
MS4647B with SOLT Calibration using 3654D Cal Kit

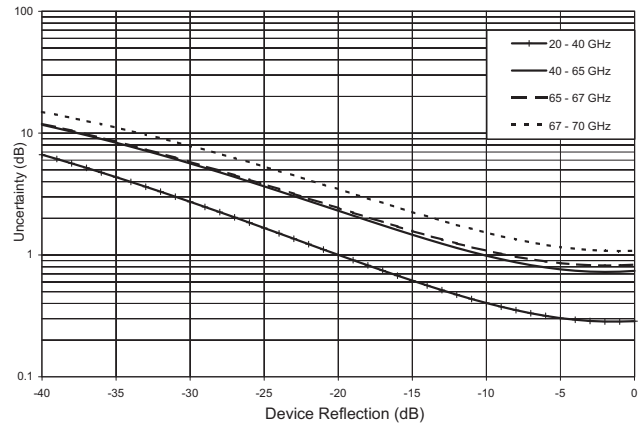

Reflection Phase Uncertainty (1 of 2)  
MS4647B with SOLT Calibration using 3654D Cal Kit

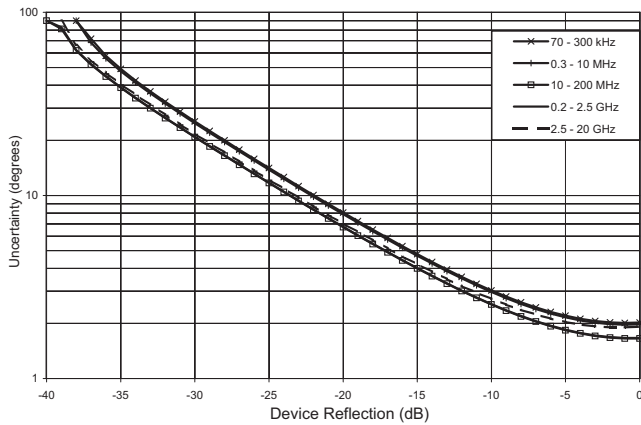

Reflection Phase Uncertainty (2 of 2)  
MS4647B with SOLT Calibration using 3654D Cal Kit

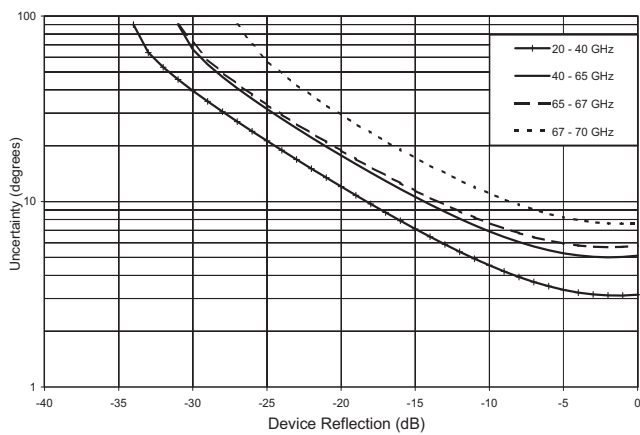

**MS4647B VNA with .s1p Calibration and 3654D-3 or 3654D-4 Calibration Kit**

Frequency Range (GHz) <sup>a</sup>	Directivity (dB)	Source Match (dB)	Load Match <sup>b</sup> (dB)	Reflection Tracking (dB)	Transmission Tracking (dB)
70 kHz to 0.01	> 47	> 47	> 46	± 0.02	± 0.05
> 0.01 to < 2.5	> 47	> 47	> 46	± 0.01	± 0.05
2.5 to 20	> 46	> 42	> 46	± 0.01	± 0.07
> 20 to 35	> 44	> 42	> 44	± 0.01	± 0.07
> 35 to 40	> 44	> 41	> 44	± 0.03	± 0.08
> 40 to 50	> 42	> 37	> 42	± 0.05	± 0.1
> 50 to 65	> 42	> 34	> 42	± 0.06	± 0.1
> 65 to 67	> 40	> 34	> 40	± 0.1	± 0.12
> 67 to 70	> 37	> 34	> 37	± 0.15	± 0.12

- a. The performance levels for the s1p calibration processes are contingent on the pin depth of the connector at the reference plane (and of any DUT connector) meeting Anritsu specifications.
- b. Since Residual Load Match is limited by Residual Directivity and the user test port cable, it can only be specified as Residual Directivity. For practical considerations, derate it by approximately 8 dB for a 3670 series test port cable, to compensate for effects such as match, repeatability, bend radius, and similar parameters.

**MS4647B Measurement Uncertainties (Transmission)**

The graphs give measurement uncertainties after the above calibration. The errors are a worst-case contribution of residual directivity, load and source match, frequency response and isolation, network analyzer dynamic accuracy, and connector repeatability. 10 Hz IF Bandwidth is used. For transmission uncertainties, it is assumed that  $S_{11} = S_{22} = 0$ . For reflection uncertainties, it is assumed that  $S_{21} = S_{12} = 0$ . All calibrations and measurements were performed at 0 dBm or default port power, whichever is less. Graphs calculated not using Options 51, 61, or 62. Those options affect noise floor and will shift the low transmission uncertainties accordingly. For other conditions, please use our free Exact Uncertainty Calculator software, available for download from the Anritsu web site at [www.anritsu.com](http://www.anritsu.com).

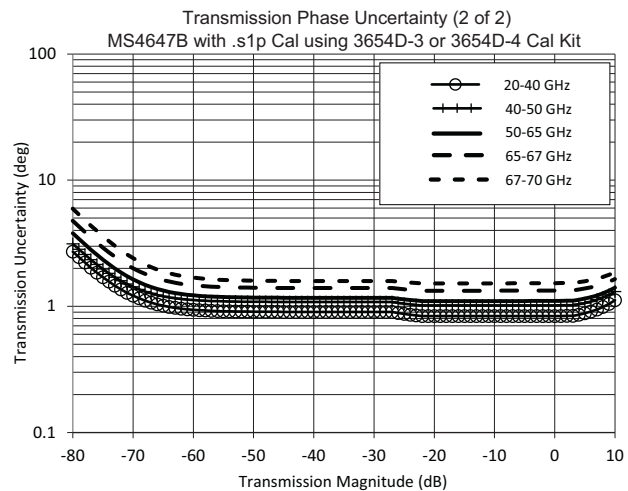
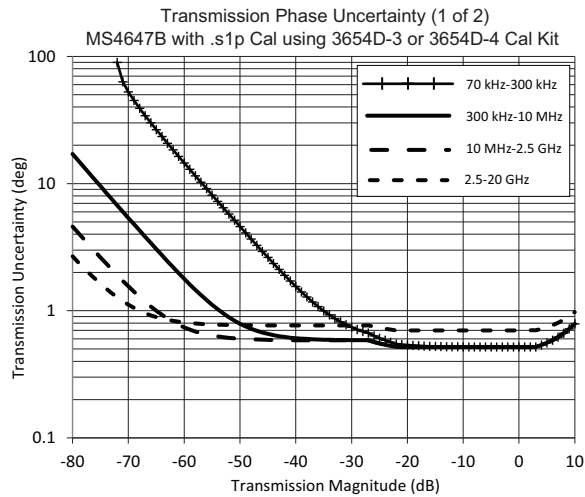
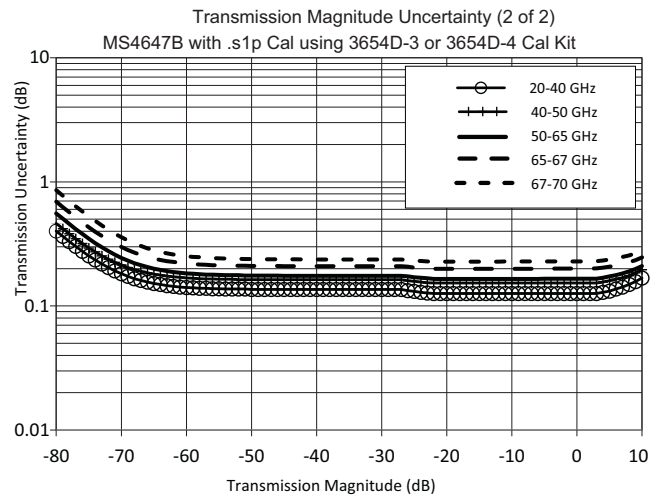
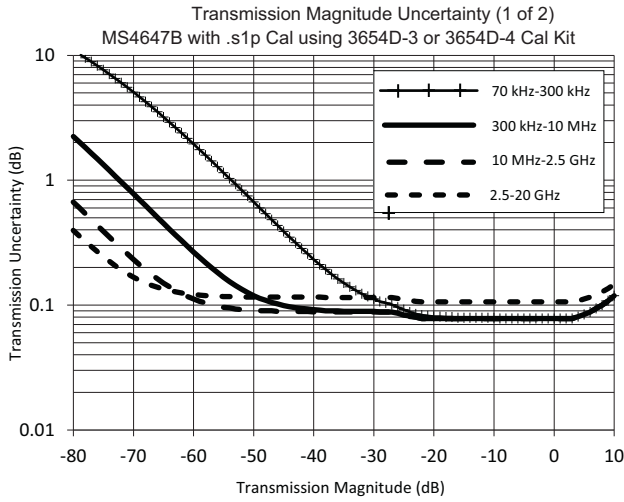

**MS4647B Measurement Uncertainties (Reflection)**

The graphs give measurement uncertainties after the above calibration. The errors are a worst-case contribution of residual directivity, load and source match, frequency response and isolation, network analyzer dynamic accuracy, and connector repeatability. 10 Hz IF Bandwidth is used. For transmission uncertainties, it is assumed that  $S_{11} = S_{22} = 0$ . For reflection uncertainties, it is assumed that  $S_{21} = S_{12} = 0$ . All calibrations and measurements were performed at 0 dBm or default port power, whichever is less. Graphs calculated not using Options 51, 61, or 62. Those options affect noise floor and will shift the low transmission uncertainties accordingly. For other conditions, please use our free Exact Uncertainty Calculator software, available for download from the Anritsu web site at [www.anritsu.com](http://www.anritsu.com).

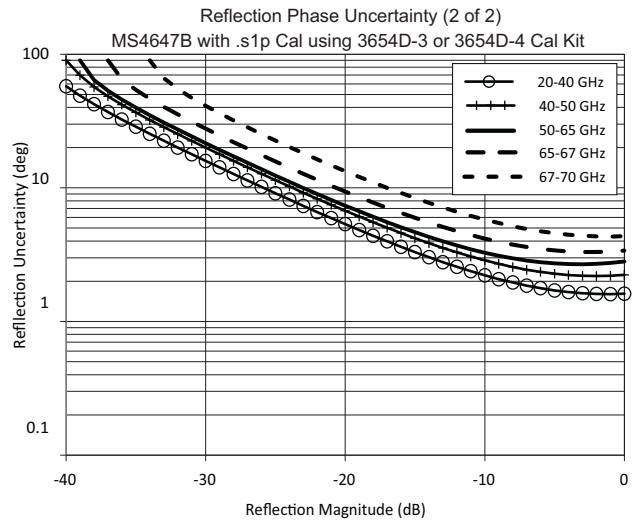
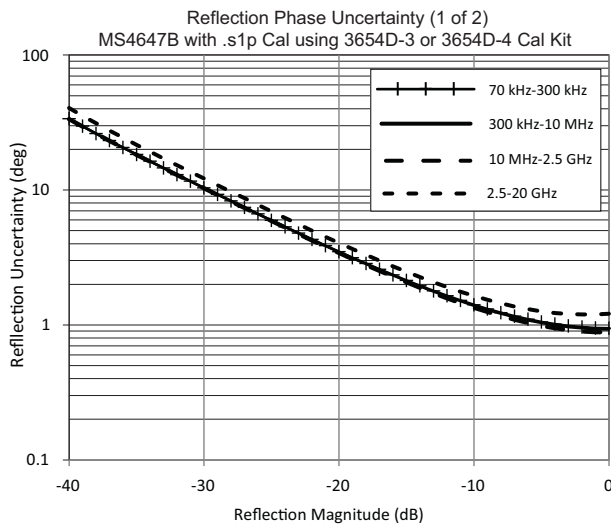
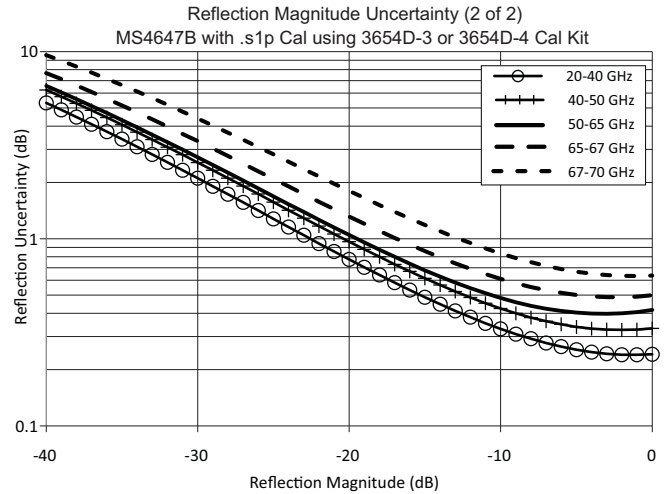
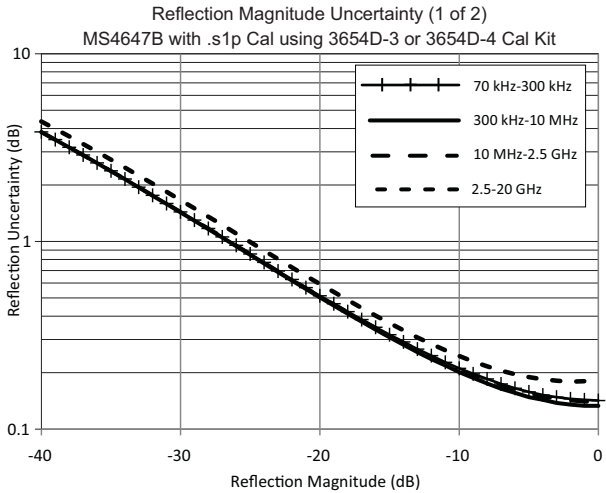

**MS4647B VNA – LRL – 3657-1 V Multi-Line Calibration Kit**

MS4647B 70 GHz VNA, with an LRL Calibration, using the 3657-1 V Multi-Line Calibration Kit, with symmetric reflects.

Frequency Range (GHz)	Directivity (dB)	Source Match (dB)	Load Match <sup>a</sup> (dB)	Reflection Tracking (dB)	Transmission Tracking (dB)
0.24 <sup>b</sup> to < 2.5	> 50	> 50	> 50	± 0.005	± 0.02
2.5 to 20	> 50	> 50	> 50	± 0.005	± 0.02
> 20 to 40	> 50	> 50	> 50	± 0.005	± 0.02
> 40 to 65	> 45	> 50	> 45	± 0.015	± 0.02
> 65 to 67	> 45	> 50	> 45	± 0.03	± 0.04
> 67 to 70	> 45	> 45	> 45	± 0.10	± 0.08

a. Since Residual Load Match is limited by Residual Directivity and the user test port cable, it can only be specified as Residual Directivity. For practical considerations, derate it by approximately 8 dB for a 3670 series test port cable, to compensate for effects such as match, repeatability, bend radius, and similar parameters.

b. Limited to about 240 MHz, due to the longest line delta of 34.84 mm in the 3657 Series Multi-Line Calibration Kit.

**MS4647B Measurement Uncertainties (Transmission)**

The graphs give measurement uncertainties after the above calibration. The errors are a worst-case contribution of residual directivity, load and source match, frequency response and isolation, network analyzer dynamic accuracy, and connector repeatability. 10 Hz IF Bandwidth is used. For transmission uncertainties, it is assumed that  $S_{11} = S_{22} = 0$ . For reflection uncertainties, it is assumed that  $S_{21} = S_{12} = 0$ . All calibrations and measurements were performed at 0 dBm or default port power, whichever is less. Graphs calculated not using Options 51, 61, or 62. Those options affect noise floor and will shift the low transmission uncertainties accordingly. For other conditions, please use our free Exact Uncertainty Calculator software, available for download from the Anritsu web site at [www.anritsu.com](http://www.anritsu.com).

Transmission Magnitude Uncertainty (1 of 2)  
MS4647B with LRL Calibration using 3657-1 Cal Kit (> 5 GHz)  
with LRM Calibration using 3654D Cal Kit (< 5 GHz)

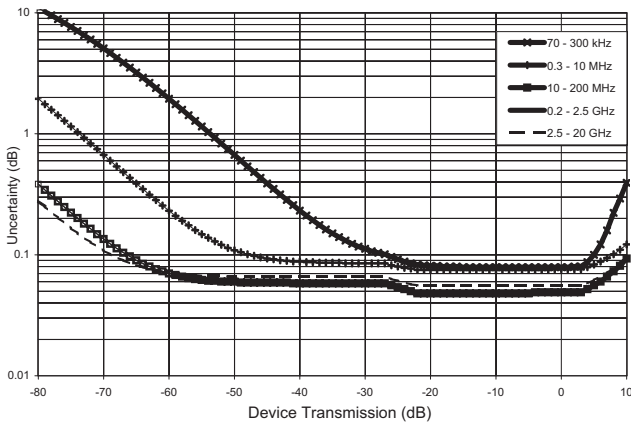

Transmission Magnitude Uncertainty (2 of 2)  
MS4647B with LRL Calibration using 3657-1 Cal Kit (> 5 GHz)  
with LRM Calibration using 3654D Cal Kit (< 5 GHz)

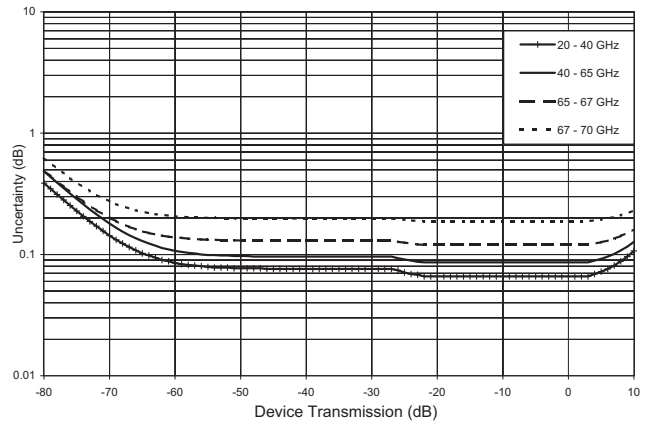

Transmission Phase Uncertainty (1 of 2)  
MS4647B with LRL Calibration using 3657-1 Cal Kit (> 5 GHz)  
with LRM Calibration using 3654D Cal Kit (< 5 GHz)

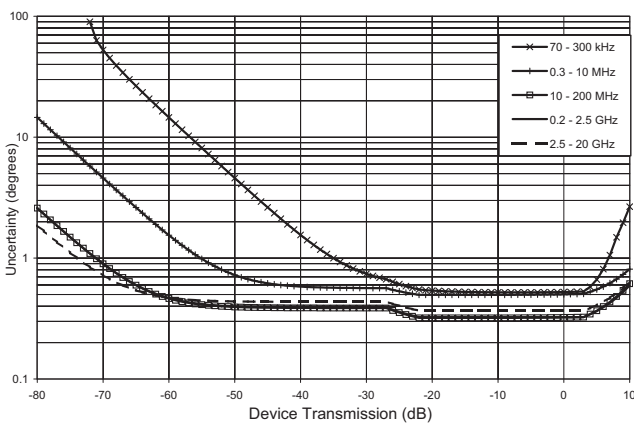

Transmission Phase Uncertainty (2 of 2)  
MS4647B with LRL Calibration using 3657-1 Cal Kit (> 5 GHz)  
with LRM Calibration using 3654D Cal Kit (< 5 GHz)

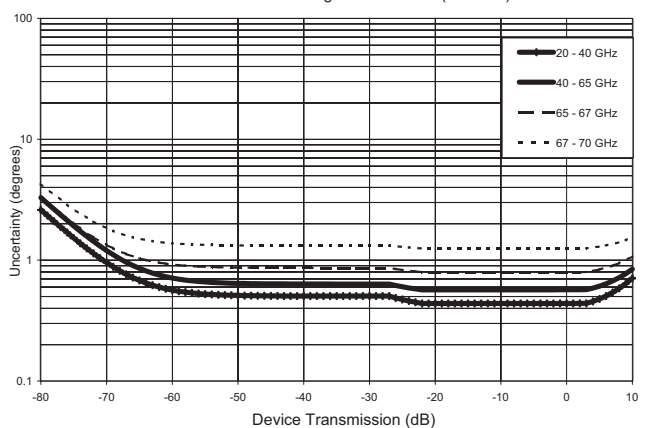

**MS4647B Measurement Uncertainties (Reflection)**

The graphs give measurement uncertainties after the above calibration. The errors are a worst-case contribution of residual directivity, load and source match, frequency response and isolation, network analyzer dynamic accuracy, and connector repeatability. 10 Hz IF Bandwidth is used. For transmission uncertainties, it is assumed that  $S_{11} = S_{22} = 0$ . For reflection uncertainties, it is assumed that  $S_{21} = S_{12} = 0$ . All calibrations and measurements were performed at 0 dBm or default port power, whichever is less. Graphs calculated not using Options 51, 61, or 62. Those options affect noise floor and will shift the low transmission uncertainties accordingly. For other conditions, please use our free Exact Uncertainty Calculator software, available for download from the Anritsu web site at [www.anritsu.com](http://www.anritsu.com).

Reflection Magnitude Uncertainty (1 of 2)  
MS4647B with LRL Calibration using 3657-1 Cal Kit (> 5 GHz)  
with LRM Calibration using 3654D Cal Kit (< 5 GHz)

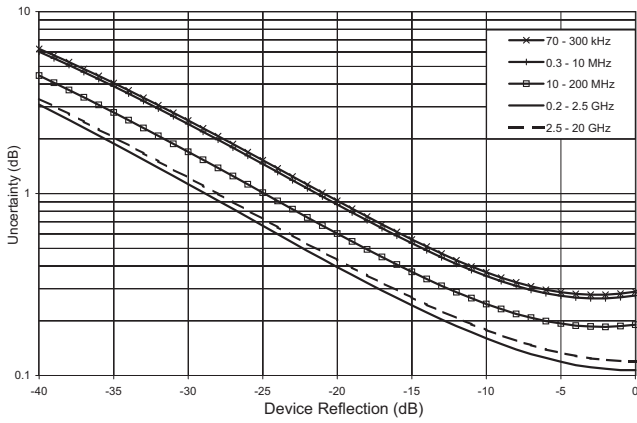

Reflection Magnitude Uncertainty (2 of 2)  
MS4647B with LRL Calibration using 3657-1 Cal Kit (> 5 GHz)  
with LRM Calibration using 3654D Cal Kit (< 5 GHz)

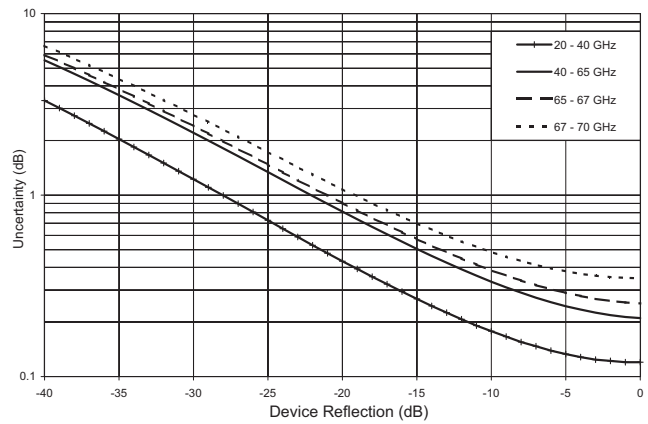

Reflection Phase Uncertainty (1 of 2)  
MS4647B with LRL Calibration using 3657-1 Cal Kit (> 5 GHz)  
with LRM Calibration using 3654D Cal Kit (< 5 GHz)

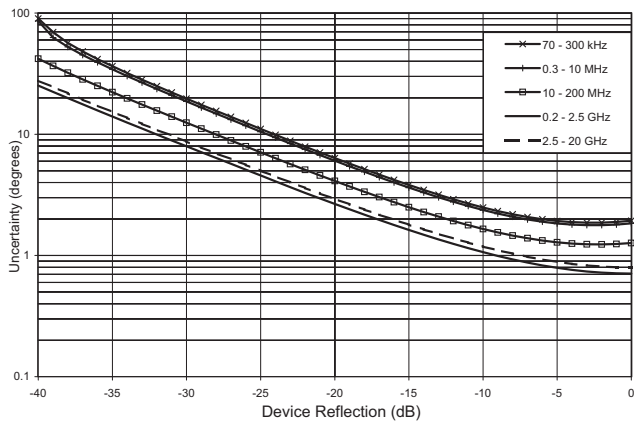

Reflection Phase Uncertainty (2 of 2)  
MS4647B with LRL Calibration using 3657-1 Cal Kit (> 5 GHz)  
with LRM Calibration using 3654D Cal Kit (< 5 GHz)

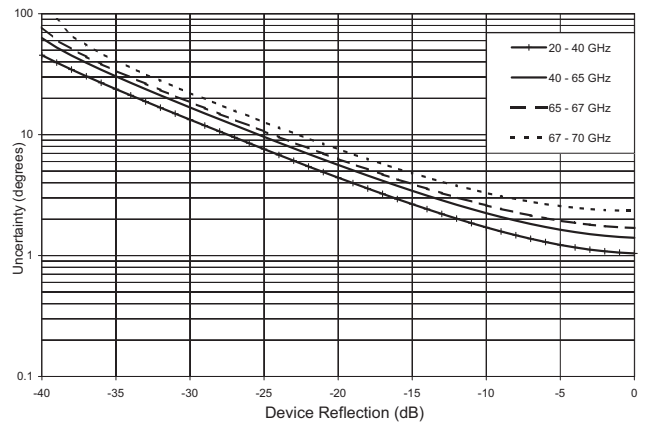

**MS4647B VNAs – 12-Term – 36585V V AutoCal**

MS4647B 70 GHz VNA, with 12-term Calibration, using the 36585V V AutoCal.

Frequency Range (GHz)	Directivity (dB)	Source Match (dB)	Load Match <sup>a</sup> (dB)	Reflection Tracking (dB)	Transmission Tracking (dB)
70 kHz to 0.01 <sup>b</sup>	> 40	> 40	> 40	± 0.10	± 0.10
> 0.01 to < 2.5	> 43	> 47	> 43	± 0.05	± 0.03
2.5 to 20	> 50	> 47	> 50	± 0.09	± 0.03
> 20 to 40	> 48	> 47	> 48	± 0.14	± 0.07
> 40 to 65	> 43	> 45	> 43	± 0.17 <sup>c</sup>	± 0.10
> 65 to 67	> 43	> 45	> 43	± 0.17	± 0.10
> 67 to 70	> 42	> 40	> 42	± 0.30	± 0.12

a. Since Residual Load Match is limited by Residual Directivity and the user test port cable, it can only be specified as Residual Directivity. For practical considerations, derate it by approximately 8 dB for a 3670 series test port cable, to compensate for effects such as match, repeatability, bend radius, and similar parameters.

b. Typical performance below 2 MHz.

c. ± 0.25 dB from 51 to 55 GHz.

**MS4647B Measurement Uncertainties (Transmission)**

The graphs give measurement uncertainties after the above calibration. The errors are a worst-case contribution of residual directivity, load and source match, frequency response and isolation, network analyzer dynamic accuracy, and connector repeatability. 10 Hz IF Bandwidth is used.

For transmission uncertainties, it is assumed that  $S_{11} = S_{22} = 0$ . For reflection uncertainties, it is assumed that  $S_{21} = S_{12} = 0$ . All calibrations and measurements were performed at 0 dBm or default port power, whichever is less. Graphs calculated not using Options 51, 61, or 62. Those options affect noise floor and will shift the low transmission uncertainties accordingly. For other conditions, please use our free Exact Uncertainty Calculator software, available for download from the Anritsu web site at [www.anritsu.com](http://www.anritsu.com).

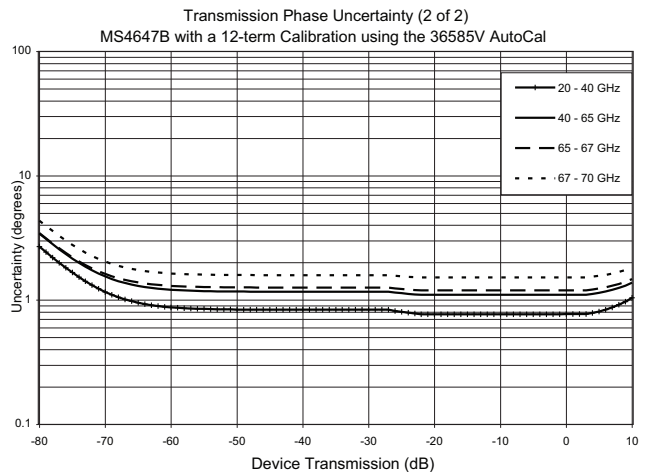
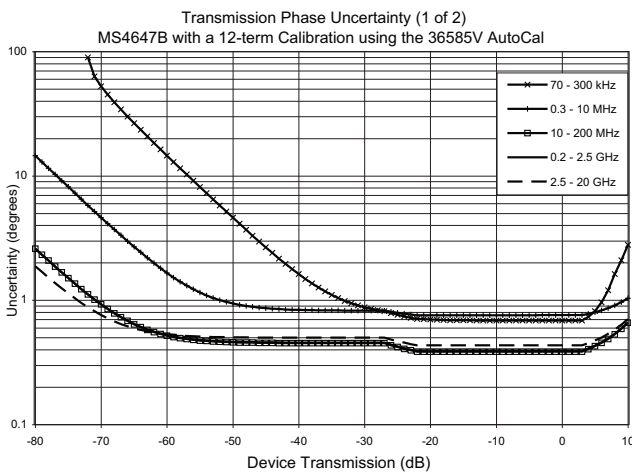
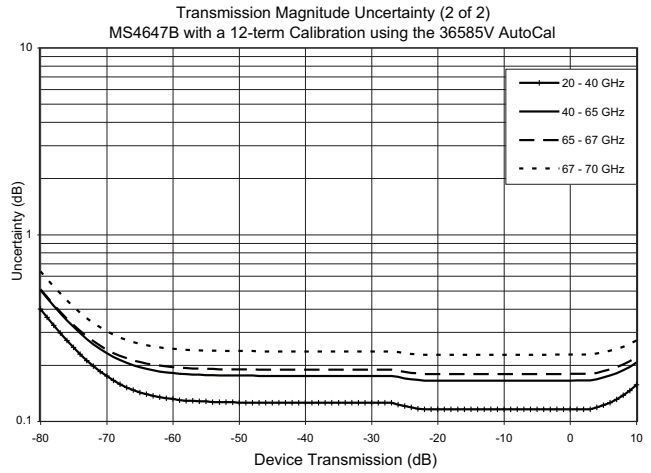
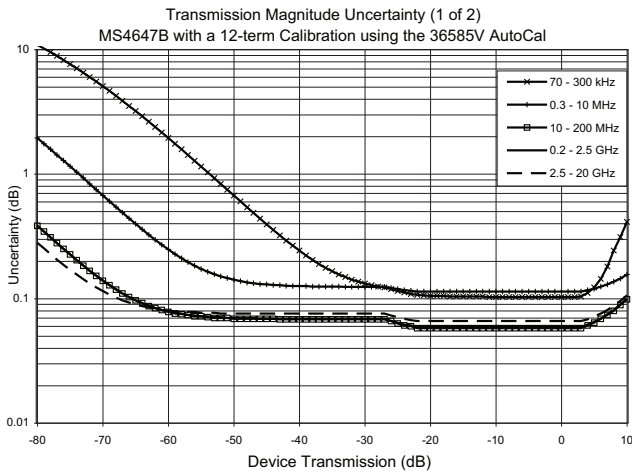



**MS4647B Measurement Uncertainties (Reflection)**

The graphs give measurement uncertainties after the above calibration. The errors are a worst-case contribution of residual directivity, load and source match, frequency response and isolation, network analyzer dynamic accuracy, and connector repeatability. 10 Hz IF Bandwidth is used. For transmission uncertainties, it is assumed that  $S_{11} = S_{22} = 0$ . For reflection uncertainties, it is assumed that  $S_{21} = S_{12} = 0$ . All calibrations and measurements were performed at 0 dBm or default port power, whichever is less. Graphs calculated not using Options 51, 61, or 62. Those options affect noise floor and will shift the low transmission uncertainties accordingly. For other conditions, please use our free Exact Uncertainty Calculator software, available for download from the Anritsu web site at [www.anritsu.com](http://www.anritsu.com).

Reflection Magnitude Uncertainty (1 of 2)  
MS4647B with a 12-term Calibration using the 36585V AutoCal

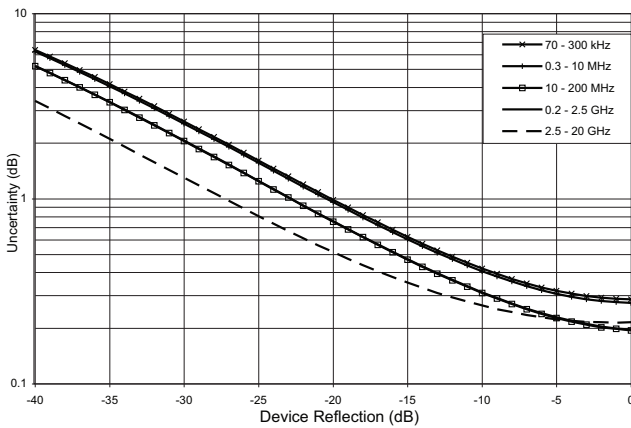

Reflection Magnitude Uncertainty (2 of 2)  
MS4647B with a 12-term Calibration using the 36585V AutoCal

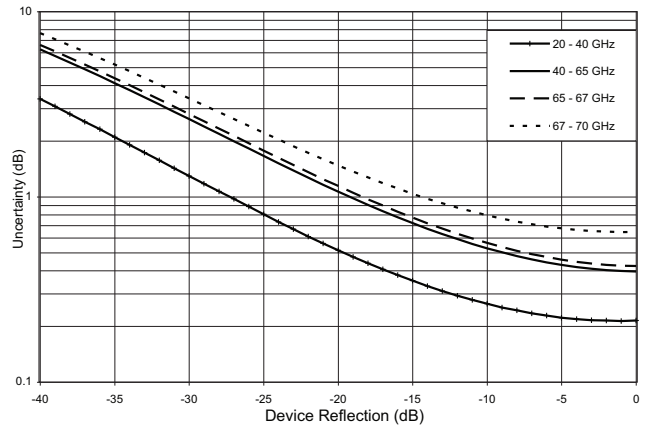

Reflection Phase Uncertainty (1 of 2)  
MS4647B with a 12-term Calibration using the 36585V AutoCal

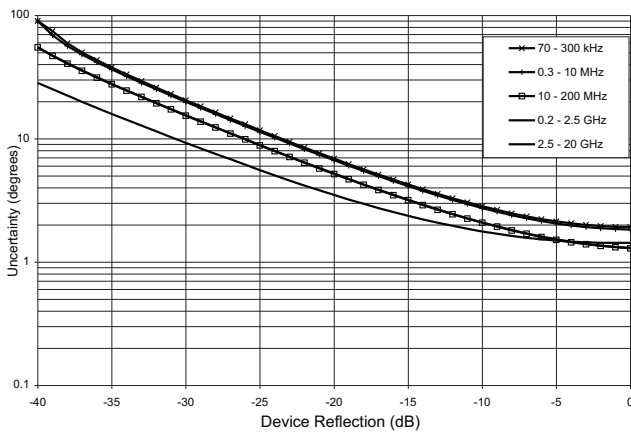

Reflection Phase Uncertainty (2 of 2)  
MS4647B with a 12-term Calibration using the 36585V AutoCal

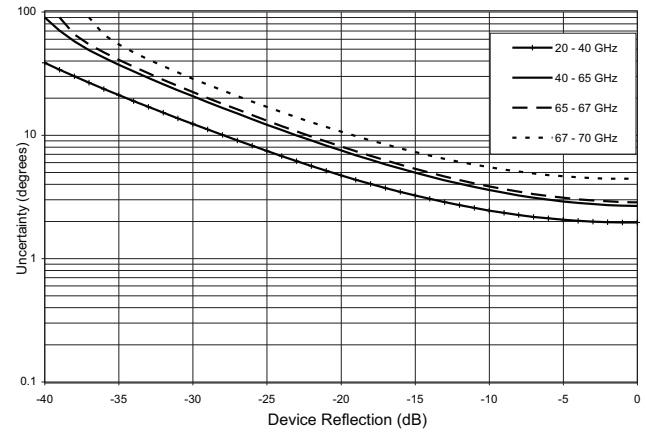

## Measurement Times

Measurement times include sweep time, and band-switching time, in single channel mode. (typical performance)

~30  $\mu$ s/point is achieved in true swept mode, with 100,000 points, with ALC turned on for level accuracy, with display turned-on for tuning purposes, with locking turned-on for frequency accuracy and repeatability, with correction turned on to meet published residual specifications, and over the full span of the product with all band-switch points to fully characterize a device.

### Measurement Time (ms), SYNTHESIZED Sweep, Display ON and ALC ON

Calibration	Sweep Width	IFBW	Measurement Time (ms)			
			401 Points	1,601 Points	25,000 Points	100,000 Points
Uncorrected or 1-port calibration	Narrow ( $\leq$ 1 GHz span without band-switch points)	1 MHz	20	60	890	3,300
		30 kHz	30	110	1,600	6,100
		1 kHz	380	1,600	25,000	100,000
	Wide (70 GHz span)	1 MHz	50	90	1,000	3,400
		30 kHz	60	140	1,700	6,200
		1 kHz	420	1,670	25,000	100,000
2-port calibration (per sweep)	Narrow ( $\leq$ 1 GHz span without band-switch points)	1 MHz	20	60	890	3,300
		30 kHz	30	110	1,600	6,100
		1 kHz	400	1,610	25,000	100,000
	Wide (70 GHz span)	1 MHz	50	90	1,000	3,400
		30 kHz	60	140	1,700	6,200
		1 kHz	420	1,670	25,000	100,000

### Measurement Time (ms) vs. Noise Floor (dBm), SYNTHESIZED Sweep, Display ON and ALC ON

Calibration	Full Band Sweep	Measurement Time 1,601 Points	Achieved Noise Floor at Maximum Frequency (dBm)	IFBW (kHz)
2-port calibration (per sweep)	MS4642B	110	-85	100
		210	-95	10
	MS4644B	115	-80	100
		210	-90	10
	MS4647B	120	-75	100
		210	-85	10

## Standard Capabilities

<b>Operating Frequency</b>	
MS4642B	10 MHz to 20.2 GHz
MS4644B	10 MHz to 40.5 GHz
MS4647B	10 MHz to 70 GHz
MS4640B-070	Optional for MS4640B series VNAs. Provides 40 kHz to 10 MHz Coverage Extension. Provides a lower limit specified to 70 kHz, which is allowed to extend to 40 kHz.
<b>Measurement Parameters</b>	
2-Port Measurements	$S_{11}$ , $S_{21}$ , $S_{22}$ , $S_{12}$ , and any user-defined combination of $a_1$ , $a_2$ , $b_1$ , $b_2$ , and 1.
4-Port Measurements	Refer to the separate VectorStar MN469xC Series Multiport VNA Measurement System Technical Data Sheet 11410-00777, available at <a href="http://www.anritsu.com/en-US/test-measurement/products/ms4640b-series">http://www.anritsu.com/en-US/test-measurement/products/ms4640b-series</a>
Domains	Frequency Domain, Power Domain, CW Draw, and Time (Distance) Domain
<b>Sweeps</b>	
Frequency Sweep Types	Linear, Log, CW, or Segmented
Power Sweep Types	Linear, constant power sweeps, or constant power slope (dB/GHz) over frequency sweep
<b>Display Graphs</b>	
Single Rectilinear Graph Types	Log Magnitude, Phase, Group Delay, Linear Magnitude, Real, Imaginary, Inductance, Capacitance, SWR, Power Out, Impedance, and Power In
Dual Rectilinear Graph Types	Log Magnitude and Phase, Linear Magnitude and Phase, and Real and Imaginary
Circular Graph Types	Smith Chart (Impedance), Smith Chart (Admittance), Linear Polar, and Log Polar
<b>Measurements Data Points</b>	
25,000 Data Points	2 to 25,000 points in up to 16 channels
100,000 Data Points	2 to 100,000 points in single channel
<b>Limit Lines</b>	
Limit Lines	Single or segmented. 2 limit lines per trace. 50 segments per limit line.
Single Limit Readouts	Uses interpolation to determine the intersection frequency.
Test Limits	Both single and segmented limits can be used for PASS/FAIL testing.
<b>Averaging</b>	
Point-by-Point	Point-by-point (default), max Averaging = IF Bandwidth/1 Hz
Sweep-by-Sweep	Sweep-by-sweep (no limit)
<b>IF Bandwidth</b>	
	1, 2, 3, 5, 7, 10, 20, 30, 50, 70, 100, 200, 300, 500, 700 Hz; 1, 2, 3, 5, 7, 10, 20, 30, 50, 70, 100, 200, 300, 500, 700 kHz; 1MHz
<b>Reference Plane</b>	
Line Length or Time Delay	The reference planes of a calibration or other normalization can be changed by entering a line length or time delay.
Dielectric Constants	Dielectric constants may be entered for different media so the length entry can be physically meaningful.
Dispersion Modeling	Dispersion modeling is used in the cases of microstrip and waveguide to take into account frequency dependent phase velocities.
Attenuation	Attenuation (with frequency slope) and constant phase offsets can be entered to better describe any reference plane distortions. The frequency dependence exponent is changeable.
Auto Modes	Automatic reference plane finding tools are available for phase alone or phase + magnitude. These routines do a fitting process on phase or phase and magnitude to estimate the reference plane location and enter correcting values.
De-embedding	For more complete reference plane manipulation, the full de-embedding system can also be used.
<b>Measurement Frequency Range</b>	
Frequency Range Change	Frequency range of the measurement can be narrowed within the calibration range without recalibration.
CW Mode	CW mode permits single frequency measurements also without recalibration.
Interpolation Not Activated	If interpolation is not activated, the subset frequency range is forced to use calibration frequency points.
Interpolation Activated	If interpolation is activated, any frequency range that is a subset of the calibration frequency range can be used, but there may be some added interpolation error.
<b>Group Delay</b>	
Group Delay Aperture	Defined as the frequency span over which the phase change is computed at a given frequency point.
Aperture	The aperture can be changed without recalibration.
Minimum Aperture	The minimum aperture is the frequency range divided by the number of points in calibration and can be increased to 20% of the frequency range.
Group Delay Range	< 180° of phase change within the aperture

**Channels, Display, and Traces**

Channels and Traces	16 channels, each with up to 16 traces
Display	Color touch screen LCD, 26.4 cm (10.4") diagonal
Display Colors	Unlimited colors for data traces, memory, text, markers, graticules and limit lines.
Trace Memory and Math	A separate memory for each trace can be used to store measurement data for later display or subtraction, addition, multiplication or division with current measurement data. The trace data can be saved and recalled.
Inter-trace Math	Any two traces within a channel can also be combined (via addition, subtraction, multiplication or division) and displayed on another trace. An equation editor mode is also available that allows the combination of trace data, trace memory and S-parameter data in more complex equations. Over 30 built-in functions are available. Simple editing tools and the ability to save/recall equations are also provided.

**Scale Resolution**

	Minimum per division, varies with graph type.
Log Magnitude	0.001 dB
Linear Magnitude	1 $\mu$
Inductance	1 fH
Capacitance	1 fF
Phase	0.01°
Group Delay	0.001 ps
Time	0.001 ps
Distance	0.1 $\mu$ m
SWR	1 $\mu$
Power	0.01 dB

**Markers**

Markers	12 markers per trace (x 16 traces x 16 channels, for a total of 3,072)
Marker Coupling	Coupled or decoupled within a channel
Marker Data	Data displayed in graph area or in table form
Reference Marker	Additional marker per trace for reference
Marker Statistics	Mean, maximum, minimum, standard deviation
	Per trace or over a marker region.
Marker Search and Tracking	Search and/or track for minimum, maximum, peak, or target value.

**Other**

Filter Parameters	Display bandwidth (user-selectable loss value), corner and center frequencies, loss, Q, and shape factors.
Blank Frequency Information	Blanking function removes all references to frequencies on the display. Frequency references can only be restored through a system preset or GPIB command.

**Saving Data**

.sNp	<i>(Where N=1 or 2 for two port systems, and N=1 to 4 for four port systems)</i> The traditional Touchstone® file format for loading into simulators and other tools. Tools are available for re-assigning ports and selecting the units (Hz to GHz for frequency; linear magnitude-and-phase, real-and-imaginary or log magnitude-and-phase for data; these units are listed in the file header). Selections are available to put the outputs of frequency-with-time-gating (part of Option 2), or trace math in lieu of just the calibrated S-parameter. It is also possible to enforce passivity or causality on the parameters saved in these files. Only those parameters indicated by the file extension will be saved.
.mNp	<i>(Where N=2 for two port systems, and N= 2 or 4 for four port systems)</i> This is the mixed-mode version of the Touchstone® format with mixed-mode parameters substituted for the single-ended S-parameters. Differential and common-mode port pair assignments can be changed.
.txt and .csv	These are the familiar tab-delimited and comma-delimited file formats often used in spreadsheets. All traces in the current channel will be saved using whatever trace formats are currently enabled. Frequency and time domain traces will be saved in the same file and each trace will be saved with its own frequency/time vector. An extensive header in these files denotes instrument settings.
.bmp, .png, and .jpg	These are the familiar graphics files formats. The graph area, the marker table (if active), the segmented sweep, limit line or multiple source tables (if active) and the bottom status bar are saved as part of the image. The top and side menu bars are not saved.
.tdf and .tdu	These are internal trace data formats (formatted data using the current graph type or unformatted) that can be used to recall data into trace memory at a later time.

**Remote Operability**

VectorStar supports several remote operability options.

Communication Type	Data Format	Performance	Description
Via GPIB	Using IEEE 488.2	1 MB/s Data Transfer Speed	Use SCPI or previous generation Lightning VNA commands. Also compatible with a fundamental set of HP/Agilent 8510x VNA commands.
Via LAN	Using VXI-11 Protocol	2.5 MB/s Data Transfer Speed	
Via USB	Using USBTMC Protocol	5.5 MB/s Data Transfer Speed	
Drivers for GPIB, LAN, or USB	National Instruments LabVIEW and LabWindows/CVI drivers are available for download from both the Anritsu and National Instruments web sites. .NET/COM driver for Windows™ Applications such as Visual Studio 6 thru VS 2005, VB6, C#, C++, C, Visual C, HP Vee, and more are available for download from the Anritsu web site. These drivers require VISA runtime, not provided by Anritsu. NI VISA version 3.2 or higher is recommended for .NET and USB support.		
Triggering	Internal, External, GPIB Single point, Single Sweep, and Single Channel. All Channels are hand-shaking for optimum tandem sweeps (check rear panel connections).		

**Throughput Time**

Throughput Time (ms), Synthesized Sweep, Display ON and ALC ON, single 20 GHz sweep, 30 kHz IFBW, including trigger and data transfer time.

Communication Type	Data Format	Measurement Time (typical)		
		401 points	1,601 points	100,000 points
GPIB (IEEE-488.2)	32- or 64-bit Floating	380	410	6,400
	ASCII	290	370	7,400
LAN (VXI-11)	32- or 64-bit Floating	280	320	6,300
	ASCII	290	350	7,400
USB (USBTMC class)	32- or 64-bit Floating	280	310	6,000
	ASCII	290	350	6,800

## Calibration and Correction Capabilities

<b>Calibration Methods</b>		<p>Short-Open-Load-Through (SOLT) with Fixed or Sliding Load and supporting .s1p-defined cal kits          Offset-Short-Offset-Short-Load-Through (SSLT) with Fixed or Sliding Load          Triple-Offset-Short-Through (SSST)          Short-Open-Load-Reciprocal (SOLR) or Unknown Through Method (SSLR, SSSR)          Thru-Reflect-Line (TRL) – (up to 5 bands supported)          Line-Reflect-Line (LRL) / Line-Reflect-Match (LRM) – (up to 5 bands supported)          Advanced-LRM (A-LRM™) for improved on-wafer calibrations          Multiline Thru-Reflect-Line (mTRL)          AutoCal          Thru Update available          Secondary match correction available for improved low insertion loss measurements</p>
<b>Correction Models</b>		<p>2-Port (Forward, Reverse, or both directions)          1-Port (<math>S_{11}</math>, <math>S_{22}</math>, or both)          Transmission Frequency Response (Forward, Reverse, or both directions)          Reflection Frequency Response (<math>S_{11}</math>, <math>S_{22}</math>, or both)</p>
<b>Merged Calibration</b>		Merge multiple calibrations over bands of frequency points and with different algorithms
<b>Coefficients for Calibration Standards</b>		<p>Use the Anritsu calibration kit USB Memory Device to load kit coefficients and characterization files.          Enter manual coefficients into user-defined locations.          Complex load models are available.          Full .s1p definitions of calibration standards can be loaded.</p>
<b>Reference Impedance</b>		Modify the reference impedance from 50 $\Omega$ to any impedance greater than 0 $\Omega$ .
<b>Interpolation</b>		Allows interpolation between calibration frequency points. Accuracy will be reduced at non-calibration frequencies and that degradation is dependent on the frequency step size in the initial calibration and the electrical length of the user's setup.
<b>Adapter Removal Calibration</b>		Characterizes and “removes” an adapter that is used during calibration that will not be used for subsequent device measurements; for accurate measurement of non-insertable devices.
<b>Dispersion Compensation</b>		Selectable as Coaxial, other non-dispersive (e.g., for coplanar waveguide), Waveguide, or Microstrip.
<b>Power</b>		
Power Meter Correction		Different power meter calibrations are available to enhance power accuracy at the desired reference plane. The source power will match the target calibration power, as read by the power meter, to within ~0.1 dB for short periods of time (determined by thermal drift of the system and the power meter). The absolute accuracy of the calibrated power will be dependent on the power meter and sensor used.
Flat Power Calibrations		A flat power calibration (when in frequency sweep mode) is available at a user-selectable power level, if it is within the power adjustment range of the internal source. The flat power correction is applied to other power levels.
Linear Power Calibrations		A linear power calibration is performed over a range of power levels for use in power sweep mode and is performed at a specified frequency or frequency range.
External Power Meter		Both calibrations are performed using an external power meter (Anritsu ML2438A, ML248xB, ML249xA, Agilent 437, or equivalent) over the Dedicated GPIB port, or a USB power sensor (Anritsu MA24106A, MA24108A, MA24118A, MA24126A, MA24208A, MA24218A, MA24330A, MA24340A, MA24350A, MA24507A, or MA24510A) connected to a USB port. Note: Usage of the MA24500A series sensor requires a dual USB Type A male to single USB Type A female cable to supply needed current draw.
<b>Embedding/De-embedding</b>		The MS4640B is equipped with an Embedding/De-embedding system.
De-embedding		De-embedding is generally used for removal of test fixture contributions, modeled networks and other networks described by S-parameters (s2p files) from measurements.
Embedding		Similarly, the Embedding function can be used to simulate matching circuits for optimizing amplifier designs or simply adding effects of a known structure to a measurement.
Multiple Networks		Multiple networks can be embedded/de-embedded and changing the port and network orientations is handled easily.
Extraction Utility		An extraction utility is part of this package that allows the easier computation of de-embedding files based on some additional calibration steps and measurements.
<b>Impedance Conversion</b>		Allows entry of different reference impedances (complex values) for different ports

<b>Mixer Setup</b>	Mixer setup provides assistance to configure common mixer measurements including a simple, yet accurate, calibration methodology.
Mixer Setup – Single Channel	The prime objective of the guided Mixer Setup Single Channel is to help configure the frequency plan of the measurement using easy-to-understand diagrams. Mixers using harmonics of the LO are supported as are mm-wave configurations (see ME7838x documentation).
Mixer Setup – Multiple Channel	The Mixer Setup Multiple Channels helps configure measurement channels to handle any of a suite of possible mixer measurements and to list the required calibration steps.
Mixer Calibration	Both of these tools are coupled with the mixer calibration menu system that enables both scalar and vector-corrected measurements. The user can be directed to power calibrations that are automatically set up based on the mixer configuration.
Dual Source Mixer	Allows easier external mixer setups and can take advantage of the flexibility of having two independent internal sources within the VNA.

**Optional Capabilities**

**Time Domain Measurements — Option 2**

Displays all S-parameters and overlays with Frequency Domain, Low-pass Mode, Band-pass Mode, Phasor Impulse Mode, Windowing, Gating (pass-band or reject-band), and Frequency with Time Gate. Low-pass mode requires a harmonically related frequency list (step size = start frequency). A harmonic sweep tool is available to help with this setup. In low-pass mode, the impulse or step response can be displayed (the latter for a TDR-like presentation). When applying gating, the impedance levels at gate edges can be changed to simplify de-embedding operations.

**Receiver Offset — Option 7**

Independent Source/Receive Functions	Allows for independent source and receive functions for Mixer, Harmonics, IMD and other measurements, where the source and receive frequencies are offset.
Multiple Source Control Mode	To independently control the frequencies of up to four external sources, in addition to the internal source(s), and the receiver, in a synchronized manner.
NxN Frequency-Translated Devices	Provides calibration and measurements capability for NxN Frequency-translated devices. For accurate and absolute magnitude and phase measurements of match, gain/loss, and group delay of devices such as mixers and converters.

**Universal Fixture Extraction — Option 21**

Provides a suite of additional network extraction techniques for different de-embedding problems, particularly those when only partial interface information is available at the DUT plane. These are often useful for on-wafer and fixtured environments with more complex DUT interfaces where traditional standards may not be available. In most cases, .s1p definition/model of reflect standards is allowed and generally automatic fixture length detection is available. In addition, a sequential extraction (peeling) of isolated fixture defects is possible and allows one to generate sNp files for portions of the fixture for design analysis.

**Dual Source Architecture — Option 31**

Description	Adds a second internal source to the VNA structure and removes the transfer switch. This architecture results in higher test port power and improved dynamic range. Combined with Option 7 Receiver Offset, allows two sources and the receiver to be active at the same time and at independent frequencies. When both sources are active and at the same frequency, a relative phase shift can be set between them. When combined with Option 43 DifferentialView™, adds the ability to perform true mode stimulus measurements of differential devices. The dual source mixer capability allows the flexibility of two independent sources within the VNA to allow external mixer measurements.
Required Options	None, except with the dual source mixer applications which require Option 7.
System Compatible Options	Option 2 Time Domain Option 7 Receiver Offset Option 21 Universal Fixture Extraction Option 32 Internal RF Combiner Option 35 IF Digitizer Option 36 Extended IF Digitizer Memory Option 41 Noise Figure Option 42 PulseView™ Option 43 DifferentialView™ Option 44 IMDView™ Option 46 Fast CW Option 47 Eye Diagram Option 48 Differential Noise Figure Option 51 Direct Access Loops Option 53 External ALC Options 61/62 Active Measurements Suite Option 70 70 kHz Low Frequency Extension Options 84/85 Broadband/Banded/Millimeter-Wave Extension Options 88/89 Broadband/Banded/Millimeter-Wave Extension. Maximum frequency available is 110 GHz.
Incompatible Options	Options 80/81 Broadband/Millimeter-Wave Options 82/83 Banded/Millimeter-Wave Extension Options 86/87 Broadband/Millimeter-Wave. Maximum frequency available is 110 GHz.

**Internal RF Combiner — Option 32**

Description	Adds an internal combiner to combine Source 2 of the Dual Source Architecture option (Option 31) with Source 1 and routes to Port 1 of the VectorStar front panel. When combined with IMDView Option 44 the configuration provides optimized intermodulation distortion (IMD) measurements. The Frequency Offset (Option 7) and Dual Source (Option 31) must be ordered with the combiner option. If IMDView Option 44 is not included, switching of the combiner is activated using the Multiple Source Control menus supplied with the frequency offset option.
Required Options	Option 7 Receiver Offset and Option 31 Dual Source Architecture
System Compatible Options	Option 2 Time Domain Option 21 Universal Fixture Extraction Option 35 IF Digitizer Option 36 Extended IF Digitizer Memory Option 41 Noise Figure Option 42 PulseView™ Option 43 DifferentialView™ Option 44 IMDView™ Option 46 Fast CW Option 47 Eye Diagram Option 48 Differential Noise Figure Option 51 Direct Access Loops Option 53 External ALC Option 61/62 Active Measurements Suite Option 70 70 kHz Low Frequency Extension Options 84/85 Broadband/Banded/Millimeter-Wave Extension Options 88/89 Broadband/Banded/Millimeter-Wave Extension. Maximum frequency available is 110 GHz.
Incompatible Options	Options 80/81 Broadband/Millimeter-Wave Options 82/83 Banded/Millimeter-Wave Extension Options 86/87 Broadband/Millimeter-Wave. Maximum frequency available is 110 GHz

**IF Digitizer — Option 35**

Description	When combined with Option 42 PulseView™, adds the capability to generate and measure pulsed signals. Four internal signal generators are included enabling singlet, doublet, triplet, quadruplet, and/or burst signal generation. Pulse measurements include pulse profile, point-in-pulse, and pulse-to-pulse capability.
Required Options	None
System Compatible Options	All
Incompatible Options	None
Multiport Systems	Compatible with the MN469xC Series Multiport System on any model VNA. Fast CW (non-pulsed) Captures up to 400 million data points per measurement channel with variable acquisition rates from 80 MHz to 400 MHz. This capability enables long time records (0.5 s to 2.5 s, depending on acquisition rate) stored in files retrievable via USB or a local area network.
Additional Information	For detailed pulse measurement theory, description, and operational information, see the VectorStar MS4640B Series VNA Calibration and Measurement Guide, 10410-00318.

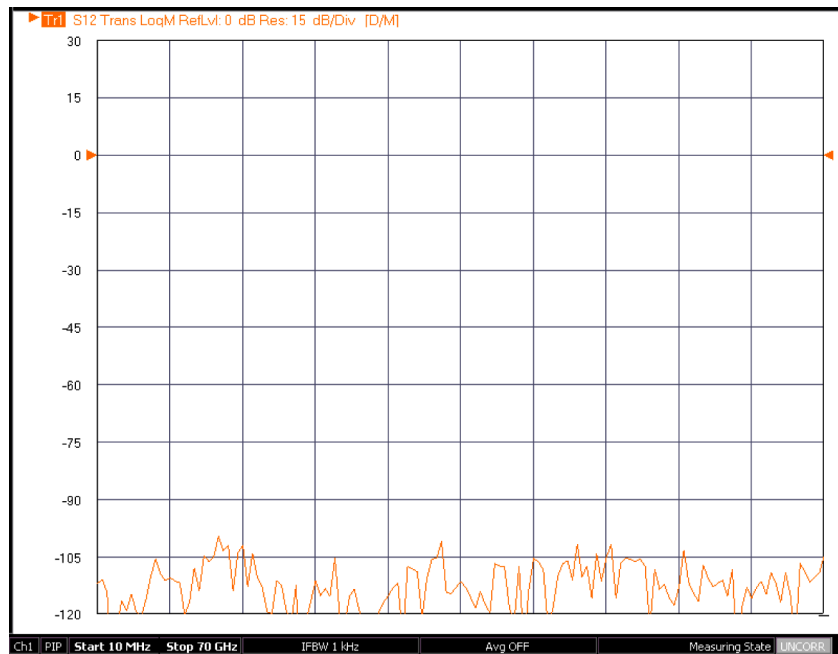

Typical plot of dynamic range with Option 35 activated.



**Extended IF Digitizer Memory — Option 36**

Description	Provides additional memory for the IF digitizer option to allow for longer record lengths. This option increases the maximum record length from 0.5 seconds to 2.5 seconds at the maximum sampling rate (minimum time resolution) with proportionate increases in record length increases at other sampling rates.
Required Options	Option 35 IF Digitizer
System Compatible Options	All
Incompatible Options	None

**Noise Figure — Option 41**

Description	Adds the capability to measure degradation of the signal-to-noise ratio caused by components in a signal chain. The Noise Figure measurement is based on a cold source technique for improved accuracy. Various levels of match and fixture correction are available for additional enhancement. Mixer noise figure measurements are supported. Compatible with mm-wave measurements in the ME7838X family with the use of receiver-only modules (e.g., 3744A-Rx).
Required Options	Option 51 or Option 61 or Option 62
System Compatible Options	Option 2 Time Domain Option 7 Receiver Offset Option 21 Universal Fixture Extraction Option 31 Dual Source Architecture Option 32 Internal RF Combiner Option 35 IF Digitizer Option 36 Extended IF Digitizer Memory Option 42 PulseView™ Option 43 DifferentialView™ Option 44 IMDView™ Option 46 Fast CW Option 47 Eye Diagram Option 53 External ALC Option 70 70 kHz Low Frequency Extension Option 81 Broadband/Millimeter-Wave Option 83 Millimeter-Wave Extension Option 85 Broadband/Banded/Millimeter-Wave Extension Option 87 Broadband/Millimeter-Wave Option 89 Broadband/Banded/Millimeter-Wave Extension
Incompatible Options	Option 48 Differential Noise Figure Option 80 Broadband/Millimeter-Wave Option 82 Banded Millimeter-Wave Extension Option 84 Broadband/Banded/Millimeter-Wave Extension Option 86 Broadband/Millimeter-Wave Option 88 Broadband/Banded/Millimeter-Wave Extension
Multiport System	MN469xC Series Multiport System on any model VNA; Noise Figure measurements can only be performed when the system is configured as a 2-Port VNA.
Additional Information	For detailed Noise Figure measurement theory, description, and operational information, see the VectorStar MS4640B Series VNA Calibration and Measurement Guide, 10410-00318.

**PulseView™ — Option 42**

Description	When combined with Option 35 IF Digitizer, adds the capability to generate and measure pulsed signals. Four internal signal generators are included enabling singlet, doublet, triplet, quadruplet, and/or burst signal generation. Pulse measurements include pulse profile, point-in-pulse, and pulse-to-pulse capability. Allows pulsed leveling of source power at an external point (e.g., after a preamplifier).
Required Options	Option 35 IF Digitizer
System Compatible Options	All
Incompatible Options	None
Multiport Systems	Compatible with the MN469xC Series Multiport System on any model VNA
Additional Information	For detailed pulse generation and measurement capability theory, description, and operation information, see the VectorStar MS4640B Series VNA Calibration and Measurement Guide - 10410-00318.
<b>Pulse Measurements</b>	Pulse profile (PP), point-in-pulse (PIP), pulse-to-pulse (P2P), continuous pulse profiling, (Cprof), and continuous point-in-pulse (CPIP)
Minimum Profile Width	2.5 ns (5 ns minimum for continuous profiling)
Minimum PIP Measurement Width	2.5 ns (5 ns minimum for continuous point-in-pulse)
P2P Measurement Width	Minimum 5 ns
Record Length	0.5 s
Pulse Repetition Frequency (PRF)	4 Hz to 67 MHz in Pulse mode; PRFs slower than 4 Hz can be measured in standard Transmission/Reflection mode with triggering.
Duty Cycle (DC) Dynamic Range Reduction (characteristic)	
1 % DC	0 dB
0.1 % DC	0 dB
0.01 % DC	0 dB
<b>Pulse Generation</b>	Four (4) internal pulse generators: PG1-PG4.
Pulse Formats	Singlet, doublet, triplet, quadruplet, and burst
Pulse Repetition Frequency (PRF) Range	4 Hz to 67 MHz
Maximum Pulse Width	0.25 s
Minimum Pulse Width	5 ns
RF Modulation	Requires an SM6628, SM6629, SM6630, or SM6631 Pulse Modulator Test Set (see next section)

**RF Modulation** (Pulse Modulator Test Sets for use with Option 42 PulseView™)

Description	Pulse Modulator Test Sets are available to pulse the RF stimulus and/or provide receiver gating (modulation). Receiver gating generally required only for higher power antenna and related applications where undesired pulses could saturate the VNA receiver. The Test Set frequency range is limited to that of the VNA with which it is used. Test Sets include necessary cabling and installation documentation.
Required Options	Option 35 IF Digitizer Option 42 PulseView™ Option 51 Direct Access Loops or Option 61/62 Active Measurements Suite
Requires one of the following compatible Pulse Modulator Test Sets	SM6628, 70 kHz to 40 GHz. Provides the MS4642B and MS4644B VNA with source modulation. SM6629, 70 kHz to 40 GHz. Provides the MS4642B and MS4644B VNA with source and receiver modulation. SM6630, 70 kHz to 70 GHz. Provides the MS4647B VNA with source modulation. SM6631, 70 kHz to 70 GHz. Provides the MS4647B VNA with source and receiver modulation.
Polarity	Low (< 1 V) = RF ON High (3.3 V ± 10 %) = RF OFF
Pulse Rise/Fall Time (typical)	5 ns (10 % to 90 %)
Insertion Loss (typical)	< 10 dB, to 20 GHz < 12 dB, 20 to 40 GHz < 15 dB, 40 to 60 GHz < 20 dB, 60 to 70 GHz
On/Off Ratio (typical)	> 100 dB, to 20 GHz > 95 dB, 20 to 60 GHz > 90 dB, 60 to 70 GHz
Max Input Power	+20 dBm max, 0 VDC max
Latency (typical)	35 ns

**DifferentialView™ — Option 43**

Description	When combined with Option 31 Dual Source Architecture, provides dual source control and calibrations required for stimulating and measuring differential devices. Allows true differential and common mode device drives. Corrects mismatch introduced error of the DUT to VNA interface via real and time calibration. This mode supports balanced in/out or combined balanced and single source drive configurations. In addition, it provides the ability to control amplitude and phase offsets of the drive conditions as well as swept phase offset for custom characterization.
Required Options	Option 31 Dual Source Architecture
System Compatible Options	All
Incompatible Options	None
Multiport Systems	Requires an MN469xC Series Multiport System for full differential characterization of a multiport device.

**IMDView™ — Option 44**

Description	When combined with Option 31, 32, and 7, IMDView provides user interface for setting up and performing IMD measurements. Interface configures and controls source routing, power and receiver calibrations, for baseband or mmWave VectorStar systems. Frequency Offset Option 7 required. If Option 31 and/or 32 are not included, the IMDView software will control external sources and perform power calibrations of external combiners.
Required Options	Option 7 Receiver Offset
System Compatible Options	Option 2 Time Domain Option 7 Receiver Offset Option 21 Universal Fixture Extraction Option 31 Dual Source Architecture Option 32 Internal RF Combiner Option 35 IF Digitizer Option 36 Extended IF Digitizer Memory Option 42 PulseView™ Option 43 DifferentialView™ Option 46 Fast CW Option 47 Eye Diagram Option 48 Differential Noise Figure Option 51 Direct Access Loops Option 53 External ALC Options 61/62 Active Measurements Suite Option 70 70 kHz Low Frequency Extension Options 84/85 Broadband/Banded/Millimeter-Wave Extension Options 88/89 Broadband/Banded/Millimeter-Wave Extension. Maximum frequency available is 110 GHz. Options 80/81 Broadband/Millimeter-Wave Options 82/83 Banded/Millimeter-Wave Extension Options 86/87 Broadband/Millimeter-Wave. Maximum frequency available is 110 GHz
Multiport System	Compatible with the MN469xC Series Multiport System on any model VNA; IMDView measurements can only be performed when the system is configured as a 2-Port VNA.
Additional Information	For detailed IMD measurement theory, description and operational information, see the VectorStar MS4640B Series VNA Calibration and Measurement Guide - 10410-00318.

**Fast CW — Option 46**

Description: Standard Mode Fast CW	If Option 35 is not installed then Standard Mode Fast CW operations are available in T/R mode via remote commands. Standard Option CW supports both continuous data streaming and buffered data collection maximum data rates of ~200,000 measurements/second. The maximum buffer size is up to 60 million measurements with transfer blocks of up to 5 million measurements. Fast transfers are available for both streaming and buffered modes. Data extraction at corrected and final formatted layers is permitted.
Description: Advanced Fast CW	With Options 35 and 46 installed, Advanced Fast CW becomes available that allows data rates of up to 100,000,000 measurements/second on all receivers at once and buffers of up to 800,000,000 measurements deep (with Option 36). Advanced Fast CW is available in the user interface as well as remotely and has on-board synchronization choices and data reduction functionality.
Required Options	Option 35 IF Digitizer (required for Advanced Fast CW only)
System Compatible Options	All
Incompatible Options	None

**Eye Diagram — Option 47**

Description	Adds the capability to calculate an eye diagram representation of what the currently measured trace data would do to a digital data stream (that can be configured by the user). This is particularly valuable in seeing the data stream signal integrity issues that could occur with a given transmission path and can help with building up subsystem simulation results. Since the eye diagram computation is per-trace, one can configure a single channel having frequency domain, time domain impulse response, TDR-like and eye diagram traces simultaneously and all responding to the same live data. Both NRZ and PAM-4 signaling available.
Required Options	Option 2 Time Domain
System Compatible Options	All
Incompatible Options	None
Additional Information	For detailed Eye Diagram measurement theory, description and operational information, see the VectorStar MS4640B Series VNA Calibration and Measurement Guide - 10410-00318.

**Differential Noise Figure — Option 48**

Description	Includes all the functionality of Option 41 and allows measurement of differential and common-mode noise properties with the cold source method. Three operating modes (uncorrelated, correlated, and combiner-based) are available for measurement efficiency and accuracy optimization. Full treatment of output port correlation is available for 3- and 4-port DUTs. Mixer noise figure measurements are supported. Various levels of vector correction are available, as is full fixture/probe embedding and de-embedding. Compatible with mm-wave measurements in the ME7838X family with the use of receiver-only modules (e.g., 3744A-Rx).
Required Options	Option 51 or Option 61 or Option 62
System Compatible Options	Option 2 Time Domain Option 7 Receiver Offset Option 21 Universal Fixture Extraction Option 31 Dual Source Architecture Option 32 Internal RF Combiner Option 35 IF Digitizer Option 36 Extended IF Digitizer Memory Option 42 PulseView™ Option 43 DifferentialView™ Option 44 IMDView™ Option 46 Fast CW Option 47 Eye Diagram Option 53 External ALC Option 70 70 kHz Low Frequency Extension Option 81 Broadband/Millimeter-Wave Option 83 Millimeter-Wave Extension Option 85 Broadband/Banded/Millimeter-Wave Extension Option 87 Broadband/Millimeter-Wave Option 89 Broadband/Banded/Millimeter-Wave Extension
Incompatible Options	Option 41 Noise Figure Option 80 Broadband/Millimeter-Wave Option 82 Banded Millimeter-Wave Extension Option 84 Broadband/Banded/Millimeter-Wave Extension Option 86 Broadband/Millimeter-Wave Option 88 Broadband/Banded/Millimeter-Wave Extension
Multiport System	MN469xC Series Multiport System on any model VNA; Differential Noise Figure measurements can be performed when the system is configured as a 2-Port VNA or a 4-Port VNA.
Additional Information	For detailed Differential Noise Figure measurement theory, description, and operational information, see the VectorStar MS4640B Series VNA Calibration and Measurement Guide, 10410-00318.

**Direct Access Loops — Option 51**

Access Loops Per Port	Adds three (3) Access loops per port for Source, Test, and Receive Paths. Note: Direct access loops are not available for VNAs equipped with Option 61 or 62, which include access loops.
Front Panel Loops	≥ 2.5 GHz Frequency Coverage loops, located at front panel.
Rear Panel Loops	< 2.5 GHz Frequency Coverage loops, located at rear panel.

**External ALC — Option 53**

External ALC access allows leveling of source power at an external point (e.g., after a preamplifier). The connector and functionality are included with Option 8x for use with the modular broadband and mm-wave functions (when in a 3739 mode, the broadband/mm-wave functionality takes precedence).

Required Options	Option 61 or 62
System Compatible Options	All
Incompatible Options	None

**Active Measurements Suite — Option 61/62**

Adds Step Attenuators, Bias Tees, Direct Access Loops, and Gain Compression and Efficiency Measurement Capabilities.

MS4642B Attenuators	70 dB, 10 dB/step
MS4644B Attenuators	70 dB, 10 dB/step
MS4647B Attenuators	60 dB, 10 dB/step
Option 61	Two (2) attenuators: One in Source 1 path, and one in Receive 2 path.
Option 62	Four (4) attenuators: One in each Source path and in each Receive path.
Bias Tees	0.5 A maximum, 40 VDC maximum 3 kHz BW (nominal), looking into a High Impedance 10 M $\Omega$ to Ground for DUT Static Discharge Protection located at rear panel.
Access Loops	Includes Option 51 loops, listed above. (Options 51, 61, and 62 are mutually exclusive)
Gain Compression	Swept Power Gain Compression at a CW frequency $P_{x\text{ dB}}$ over Swept Frequency, up to 401 points.

**70 kHz Low End Frequency Extension — Option 70**

Extends the VNA standard 10 MHz low-end start frequency to 70 kHz, providing 70 kHz to 20, 40, or 70 GHz coverage models. The low-end is allowed to extend to 40 kHz.

**Broadband/Banded/Millimeter-Wave Systems** For details on the MS464xB-08x series of options, see the:

- VectorStar ME7838A Modular Broadband/Millimeter-Wave Technical Data Sheet – 11410-00593 (For 70 kHz to 125 GHz)
- VectorStar ME7838D Modular Broadband/Millimeter-Wave Technical Data Sheet – 11410-00778 (For 70 kHz to 145 GHz)
- VectorStar ME7838E Modular Broadband/Millimeter-Wave Technical Data Sheet – 11410-00767 (For 70 kHz to 110 GHz)
- VectorStar ME7838G Modular Broadband/Millimeter-Wave Technical Data Sheet – 11410-01060 (For 70 kHz to 220 GHz)
- VectorStar ME7838A4 4-Port Modular Broadband/Millimeter-Wave Technical Data Sheet – 11410-00704 (For 70 kHz to 125 GHz)
- VectorStar ME7838D4 4-Port Modular Broadband/Millimeter-Wave Technical Data Sheet – 11410-01099 (For 70 kHz to 145 GHz)
- VectorStar ME7838E4 4-Port Modular Broadband/Millimeter-Wave Technical Data Sheet – 11410-01100 (For 70 kHz to 110 GHz)

**CPU, OS, Memory, and Security Features**

CPU	Intel Core™ i5
O/S	The Microsoft® Windows® 7 operating system on the MS4640B Series VNA is configured for optimum performance when the instrument leaves the factory.
Display	26.4 cm (10.4") Color XGA Touch-Screen Display
Storage	Serial-ATA (SATA) Solid State Drive (SSD), for OS, Programs, and Data. (> 30 GB)

**Security Features**

Display Blanking	For security, VectorStar™ software can obscure frequencies displayed on the system UI.
Removable Internal Drive	Rear Panel accessible Solid State Drive (SSD) is quickly removable and easy to secure.
Option 4 Spare SSD	A bootable SSD module is available as a spare for VectorStar units used in multiple or compartmentalized locations. The VectorStar's operating system and software are pre-installed on each Option 4 SSD.
Virus Protection, Best Practices	If the VNA is attached to a network, best practices recommend installing anti-virus software.

Front Panel Connections

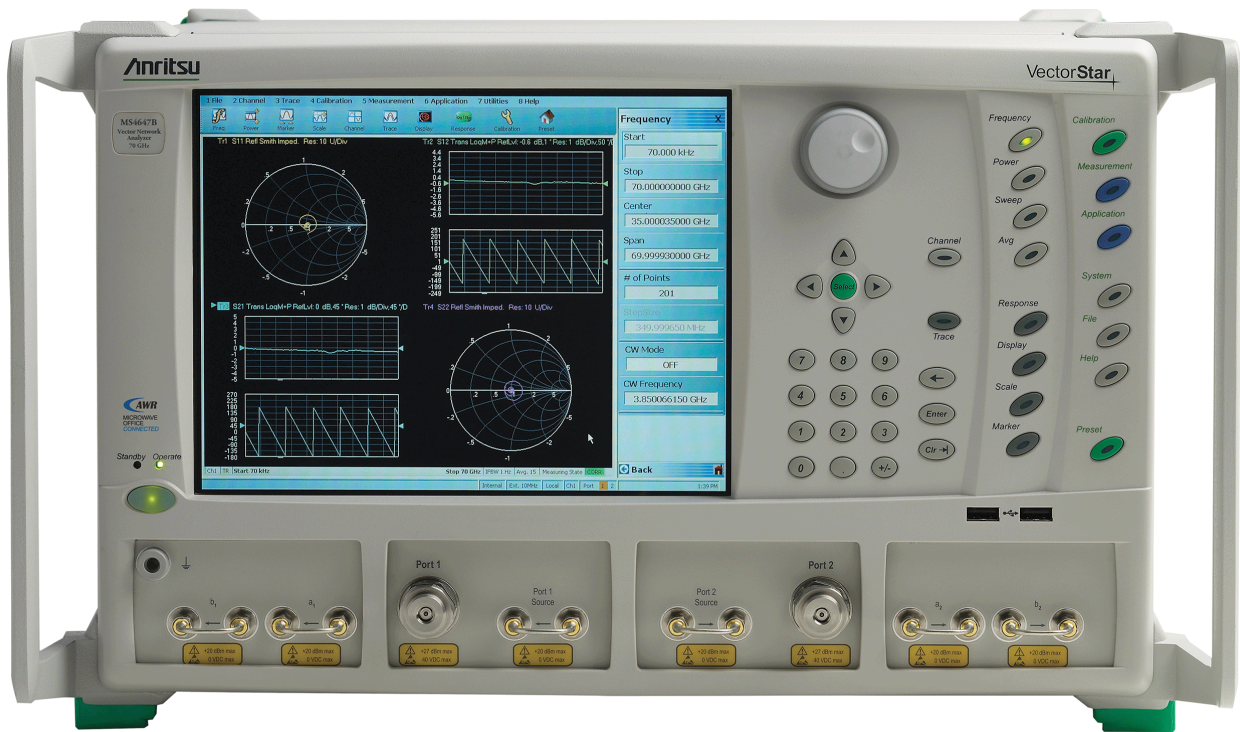

MS4640B Front Panel

**Test Ports 1 and 2**

Type	Universal Test Port Connectors, easily exchangeable in case of damage.
MS4642B and MS4644B	K (male)
MS4647B	V (male)
Damage Input Levels	+27 dBm maximum, 40 VDC maximum

**Direct Access Loops (optional)**

Type	For Source, Test and Receive paths, 3 per port, for $\geq 2.5$ GHz frequency coverage.
MS4642B and MS4644B	K (females)
MS4647B	V (females)
Damage Input Levels	+20 dBm maximum, 0 VDC maximum (+27 dBm maximum on source loop ports)

**USB Ports**

Four type A USB 2.0 Ports (two each on the front and rear panel) for peripherals such as keyboard, mouse, memory stick, hardware key, and similar devices.

**Chassis Grounding Port**

Banana (female)

**Ports to Millimeter-Wave Test Set (optional)**

Connector Type	K (female) (LO1, and LO2 for RF; One with single source; Two with Option 31 Dual Source)
----------------	--



Rear Panel Connections



MS4640B Series Rear Panel (with Option 35)

<b>AC Power Input</b>		AC Input connector, with On/Off switch, and fuses 350 VA maximum, 90 to 264 VAC, 47 to 63 Hz (power factor controlled)
<b>USB, PS/2, and LAN</b>		<p>USB Control Port Type B USB 2.0 port for controlling the instrument externally, for remote operation</p> <p>USB Ports Two Type A USB 2.0 Ports for peripherals such as keyboard, mouse, memory stick, hardware key, etc. (Two more USB ports at the front panel)</p> <p>Keyboard and Mouse Ports Dedicated PS/2 ports.</p> <p>LAN Port 10/100BaseT Ethernet</p>
<b>GPIB Ports</b>		<p>GPIB Port (Talker/Listener) Type D-24, female, IEEE 488.2 compatible, for controlling the instrument externally, for remote operation.</p> <p>GPIB Port (Dedicated Controller) Type D-24, female, for the control of external instruments such as power meters, external test sets, and similar devices.</p>
<b>External I/O Port</b>		<p>Type 25-pin D-Sub, female, User-defined I/O for custom external test set interface, to synchronize with different sweep states, such as Start, Stop, Driven Port, and similar parameters.</p> <p>Pin 1 Limit Pass/Fail</p> <p>Pins 2, 3, 15, 16 TTL In</p> <p>Pins 4, 13 14, 21 GND</p> <p>Pins 5-12, 17-20, 22 TTL Out</p> <p>Pins 23-25 Reserved</p>
<b>Serial Port</b>		9-pin D-Sub, male, compatible with RS-232, provides control for AutoCal modules and similar devices.
<b>VGA Port</b>		15-pin mini D-Sub, for simultaneously projecting the instrument's screen display onto an external VGA monitor, with 1024 x 768 minimum resolution.
<b>Bias Inputs</b>		<p>Optional Bias Inputs Requires Active Measurement Suite, Option 61 or 62</p> <p>Bias Inputs BNC (female), one per port</p> <p>Bias Fuses 0.5 A, 250 V, one per port</p>

<b>Direct Access Loops</b>		Description	For Source, Test, and Receive paths, 3 per port, for < 2.5 GHz frequency coverage.
		Required Options	Option 51, 61, or 62
		Connector Type	SMA (female)
		Damage Input Levels	+20 dBm maximum, 0 VDC maximum (+27 dBm maximum on source loop ports)
<b>IF Inputs/Outputs</b>		a <sub>1</sub> , a <sub>2</sub> , b <sub>1</sub> , b <sub>2</sub> , IF Inputs/Outputs	
		Connector Type	SMA (female)
		Inputs	Inputs used with external converters such as millimeter-wave modules, or for antenna testing. (Requires Option 8x)
		Outputs	Outputs used with external IF digitizers and processors. (Used for service.)
		Nominal Inputs	5 to 200 MHz (mode dependent), 0 dBm for full scale
		Nominal Outputs	0.2 to 200 MHz (mode dependent), +10 dBm maximum
<b>10 MHz In</b>		Signal presence is auto-sensing (better than 1000 ppm frequency accuracy is recommended).	
		Connector Type	BNC (female)
		Signal	-10 dBm to +3 dBm, 50 Ω Nominal
<b>10 MHz Out</b>		Derived from the internal reference, unless an external 10 MHz reference input is applied.	
		Connector Type	BNC (female)
		Signal	0 ± 5 dBm sinusoidal, 50 Ω Nominal
<b>Analog In 1 and 2</b>		Two independent inputs for measurements simultaneous with the RF measurements, for current sensing, efficiency computation, power detection, and similar parameters.	
		Connector Type	BNC (female)
		Range	-10 V to +10 V with automatic offset and gain calibrations
		Accuracy	2 mV + 2 % for  V  < 5 V; 2 % for  V  > 5 V
		Nominal Input Impedance	60 kΩ
<b>Ext In ALC 1 and ALC 2</b>		For external automatic level control of the internal signal source generators. The input assumes 0 V represents no RF power and a larger negative value represents increasing RF power. The maximum range is 0 to -1.3V.	
		Optional	ALC 1 is available with Option 53/80/81/82/83/86/87 ALC 1 and ALC 2 are both available with Options 31 and 53/84/85/88/89
		Connector Type	BNC (female)
<b>Ext Analog Out</b>		For external attenuator control, external switch control, analog triggering assistance, measurement system integration, and other purposes.	
		Connector Type	BNC (female)
		Normal Operating Modes	Sawtooth synch sweep, TTL indication of driving port, open loop level controller
		Range	-10 V to +10 V; low impedance drive
		Accuracy	20 mV + 2 % (Load: > 5 kΩ)
<b>Ext Trigger</b>		Connector Type	BNC (female)
		Voltage Input	0 to 3.3 V input (5 V tolerant) Low threshold = 0.8 V High threshold = 2 V
		Impedance	High impedance (> 100 kΩ)
		Pulse Width	100 ns minimum input pulse width
		Edge Trigger	Programmable edge trigger
<b>Lock Status</b>		Connector Type	BNC (female)
		Voltage Input	0 to 3.3 V input (5 V tolerant) Low threshold = 0.8 V High threshold = 2 V
		Impedance	High impedance (> 100 kΩ)
		Pulse Width	100 ns minimum input pulse width
		Edge Trigger	Positive-edge trigger
<b>Ready for Trigger</b>		Connector Type	BNC (female)
		Voltage Input	0 to 3.3 V latched output
		Impedance	Low impedance (approximately 50 Ω)
		Voltage	V <sub>(output high)</sub> = 2 V min @ -12 mA V <sub>(output low)</sub> = 0.8 V max @ +12 mA

**Trigger Out**

Connector Type	BNC (female)
Voltage Output	0 to 3.3 V pulse output 1 $\mu$ s positive pulse
Voltage	$V_{(output\ high)} = 2\ V\ min\ @\ -12\ mA$ $V_{(output\ low)} = 0.8\ V\ max\ @\ +12\ mA$
Impedance	Low impedance (approximately 50 $\Omega$ )

**Pulse Generator Outputs** All values listed are nominal.

Optional	Requires Option 35 and 42 PulseView™
Connector Type	SMA (female)
Pulse Generator Outputs	P GEN 1, P GEN 2, P GEN 3, and P GEN 4
Voltage	High: 3.3 V $\pm$ 10 % Low: < 1 V
Drive Impedance	Low impedance (approximately 50 $\Omega$ )
Load Impedance	50 $\Omega$ or higher impedance

**Pulse Synch Input** All values listed are nominal.

Optional	Requires Option 35 and 42 PulseView™
Connector Type	SMA (female)
Voltage Input	High threshold: 2.2 V Low threshold: 1 V
Signal	5.5 VDC damage level
Latency	55 ns delay from received synch to $T_0$ (typical)
Impedance	High impedance input

**Pulse Synch Output** All values listed are nominal.

Optional	Requires Option 35 and 42 PulseView™
Connector Type	SMA (female)
Voltage Output	High: 3.3 V $\pm$ 10 % Low: < 1 V
Signal	5.5 VDC damage level
Latency	< 5 ns delay from $T_0$ to providing an external synch (typical)
Drive Impedance	Low impedance (approximately 50 $\Omega$ )
Load Impedance	50 $\Omega$ or higher impedance

**Mechanical and Environmental****Dimensions**

	Dimensions listed are for the instrument without rack mount option (MS4640B-001) attached.
Height	267 mm body (6U) 286 mm between feet outer edges
Width	426 mm body 457 mm between feet outer edges 487 mm between front panel handle outer edges
Depth	502 mm body 591 mm between handle and foot outer edges

**Weight**

< 30 kg (< 66 lb) (typical weight for a fully-loaded MS4647B VNA)

**Environmental – Operating**

Specification	Conforms to MIL-PRF-28800F (class 3)
Temperature Range	0 °C to +50 °C without error codes Except for 'unleveled' error messages that may occur at the extreme edges of the temperature range.
Relative Humidity	5 % to 90 % at +30 °C, Non-condensing
Altitude	4,600 m (15,000 ft)

**Environmental – Non-Operating**

Temperature Range	-40 °C to +71 °C
Relative Humidity	0 % to 95 % at +30 °C, Non-condensing
Altitude	4,600 m (15,000 ft)

**Regulatory Compliance**

European Union	EMC 2014/30/EU, EN 61326:2013, CISPR 11/EN 55011, IEC/EN 61000-4-2/3/4/5/6/8/11 Low Voltage Directive 2014/35/EU Safety EN 61010-1:2010 RoHS Directive 2011/65/EU applies to instruments with CE marking placed on the market after July 22, 2017.
Australia and New Zealand	RCM AS/NZS 4417:2012
South Korea	KCC-REM-A21-0004



Warranty

Instrument and Built-In Options	3 years from the date of shipment (standard warranty)
Calibration Kits	Typically 1 year from the date of shipment
Test Port Cables	Typically 1 year from the date of shipment
Additional Warranty Options	Additional warranty available

Block Diagram

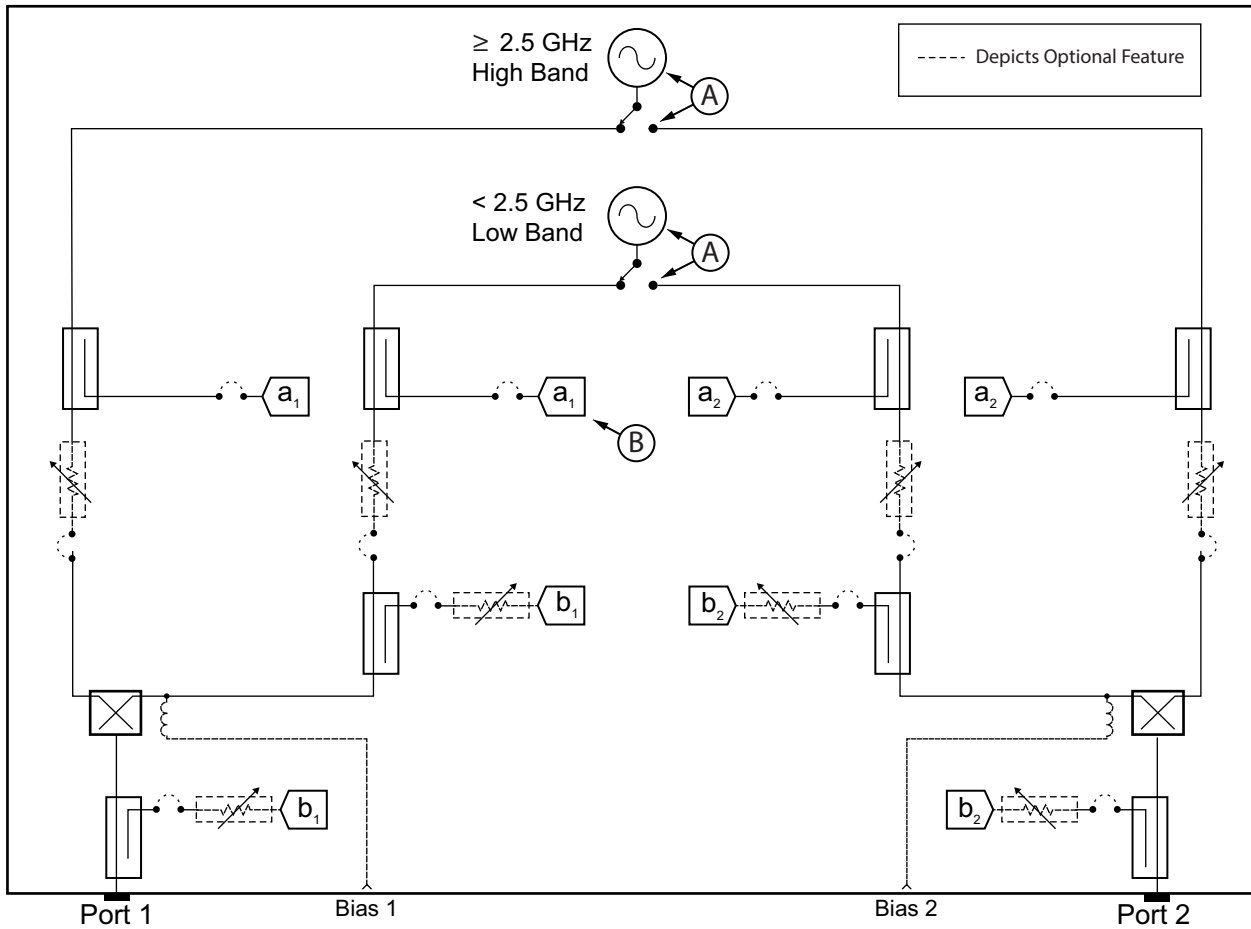

- A. With Option 31 Dual Source Architecture, second low-band and high-band sources are added and the two switches are removed. One set of sources is dedicated to each of the VNA test port paths.
- B. With Option 35 IF Digitizer, high speed digitizers are added to the receiver paths (a1, b1, a2, b2) for fast IF detection.
- C. With Option 32, Internal RF Combiner (requires Option 31 Dual Source Architecture) a switch is added that can redirect the source 2 drive signal over to a coupler embedded in the source 1 path. Option 32 adds a switch in the source 2 path after the source attenuator (after the source loop). The switch output is connected to a coupler at the input to the Port 1 test coupler. Thus two tones (one from source 1 and one from source 2) can be delivered to port 1.

MS4640B Series VNA Block Diagram – Fully Loaded Configuration

## MN4765B O/E Calibration Module

The MN4765B is a characterized, unamplified photodiode module. It is used as an optical receiver with the Anritsu MS4640B Series VectorStar™ VNAs to perform highly accurate and stable optoelectronic measurements of both modulators (E/O) and photoreceivers (O/E). Model MN4765B is the base calibration module part number only. Customers are required to also order an option to configure the bandwidth and wavelength coverage. These options consist of an InGaAs photodiode that converts modulated optical signals to electrical signals, and includes additional circuitry for temperature and bias stability. For more details on the MN4765B module, see the Technical Data Sheet 11410-00843.



MN4765B O/E Calibration Module

Configuration Option	Description	Additional Information	Part Number
40	70 kHz to 40 GHz range, with 850 wavelength coverage	RF Out K (male)	MN4765B-0040
42	70 kHz to 40 GHz range, with 850 and 1060 nm wavelength coverage	RF Out K (male)	MN4765B-0042
43	70 kHz to 40 GHz range, with 850/1060/1310/1550 nm wavelength coverage	RF Out K (male)	MN4765B-0043
70	70 kHz to 70 GHz range, with 1550 nm wavelength coverage.	RF Out V (male)	MN4765B-0070
71	70 kHz to 70 GHz range, with 1310 nm wavelength coverage.	RF Out V (male)	MN4765B-0071
72	70 kHz to 70 GHz range, with 1310 and 1550 nm wavelength coverage.	RF Out V (male)	MN4765B-0072
110	70 kHz to 110 GHz range, with 1550 nm wavelength coverage.	RF Out W1 (male), 1 mm	MN4765B-0110
Calibration Option	Description		Part Number
98	Standard Calibration – Includes Certificate of Calibration		MN4765B-0098
99	Premium Calibration – Includes Certificate of Calibration and Test Data		MN4765B-0099

### MN4765B O/E Calibration Module Features

Fast and Accurate Measurements	The MS4640B Series VectorStar series VNAs, when calibrated using the MN4765B module, enable error-corrected Transfer Function, Group Delay, and Return Loss measurements of E/O, O/E, and O/O components and subsystems.
National Institute of Standards	Magnitude and phase characterization is obtained either using a primary standard characterized by NIST or other National Metrology Institutes and held by the Anritsu calibration lab, or based on model transfer and interpolation from primary-derived characterizations at other wavelengths. The magnitude and phase data is provided on a USB drive with the module.
Temperature Stable	The MN4765B is thermally stabilized to eliminate drift in photodiode performance over temperature.
Internal Biasing	Accurate bias voltage to the photodiode is maintained internally. An external, multi-country, AC adapter is included for easy operation.
High Linearity	Linear operating range to +6 dBm for transfer function measurement uncertainties of: < 0.5 dB at 40 GHz (typical specifications for MN4765B-0043 at 1550 or 1310 nm) < 1 dB at 40 GHz (typical specifications for MN4765B-004x at 850 nm) < 2 dB at 40 GHz (typical specifications for MN4765B-0042 and MN4765B-0043 at 1060 nm) < 0.45 dB at 50 GHz and < 0.7 dB at 70 GHz (typical spec for MN4765B-0070 and MN4765B-0072 at 1550nm) < 0.35 dB at 40 GHz and < 1 dB at 70 GHz (typical spec for MN4765B-0071 and MN4765B-0072 at 1310 nm) < 0.5 dB at 70 GHz and < 0.75 dB at 110 GHz (typical specifications for MN4765B-0110)
High Responsivity	> 0.2 A/W for MN4765B-0040 (850 ± 20 nm) (typical specification) > 0.2 A/W for MN4765B-0042 (850 ± 20 nm), > 0.6 A/W (1060 ± 20 nm) (typical specification) > 0.2 A/W for MN4765B-0043 (850 ± 20 nm), >0.6 A/W (1060 ± 20 nm), >0.7 A/W (1310 ± 20 nm), and > 0.8 A/W (1550 nm ± 20 nm) (typical specification) > 0.7 A/W for MN4765B-0070 (typical specification) > 0.45 A/W for MN4765B-0071 (typical specification) > 0.45 A/W for MN4765B-0072 at 1310 nm (typical specification) > 0.65 A/W for MN4765B-0072 at 1550 nm (typical specification) > 0.5 A/W for MN4765B-0110 (typical specification)

**MN4765B O/E Calibration Module (continued)**

---

**MN4765B O/E Calibration Module General and Environmental**

Optical Input	FC/APC
Dimensions	33 H x 51 W x 127 D mm (1.3 H x 2.0 W x 5.0 D in)
AC Adapter	100 V to 240 V (50 Hz to 60 Hz) input, +12 VDC output
Power LED	On when the AC adapter is plugged in and the internal photodiode is properly biased
Operate LED	On when the module's internal temperature has stabilized at an optimum temperature for accurate calibrations and measurements
Calibrated Temperature	23 °C ± 3 °C
Operating Temperature	18 °C to 28 °C
Storage Temperature	-20 °C to 70 °C (-15 °C to 60 °C for -004x)
Relative Humidity	5 % to 95 %
EMI	Conforms to and meets the requirements of the following:
EMC Directive	Conforms to the EMC Directive, 2004/108/EC per EN 61326-1:2013
Low Voltage Directive	2006/95/EC
Emissions	EN 55011:2009 +A 1:2010 Group 1 Class A
Immunity	EN61000-4-2/3/4/5/6/11

MN4775A E/O Converter Features



Introduction

The MN4775A is an electrical to optical converter that uses an RF input signal to intensity modulate an internal laser. The E/O converter is used in conjunction with the VectorStar MS464xB series VNAs and the MN4765B optical to electrical (O/E) converter to perform highly accurate and stable optoelectronic measurements of both modulators (E/O) and photoreceivers (O/E). The MN4775A includes a laser, an optical Mach-Zehnder intensity modulator and a variable optical attenuator to control its output power. Internal circuitry provides various power and modulation configurations as well as stabilizes overall performance. Options determine the wavelength of operation: 850 nm for Option 0040, C-band (1527.6 to 1565.5 nm) for Option 0070, and 1310 nm for Option 0071.

Configuration Options

- MN4775A-0040 40 GHz modulation bandwidth and internal 850 nm laser
- MN4775A-0070 70 GHz modulation bandwidth and internal C-band laser set to 1550 nm
- MN4775A-0071 70 GHz modulation bandwidth and internal 1310 fixed laser

Features

- Fully integrated E/O to support a complete optoelectronic characterization system
- Mach-Zehnder intensity modulator and bias controller with manual and fully automatic operation modes
- Variable Optical Attenuator (VOA) for automatic or manual power control
- Internal biasing for stable operation and temperature compensation
- Internal optical power detection/monitoring
- Configurability for adapting to measurement applications
  - Optical output power control
  - Modulator biasing alternatives
- Intuitive Touchscreen Front panel control of optical components as well as remote control via rear panel USB or RS-232 connections
- In Options -0070 and -0071, a jumper loop is provided which enables using an external laser (with the internal modulator and output control) from 1250 nm to 1610 nm.

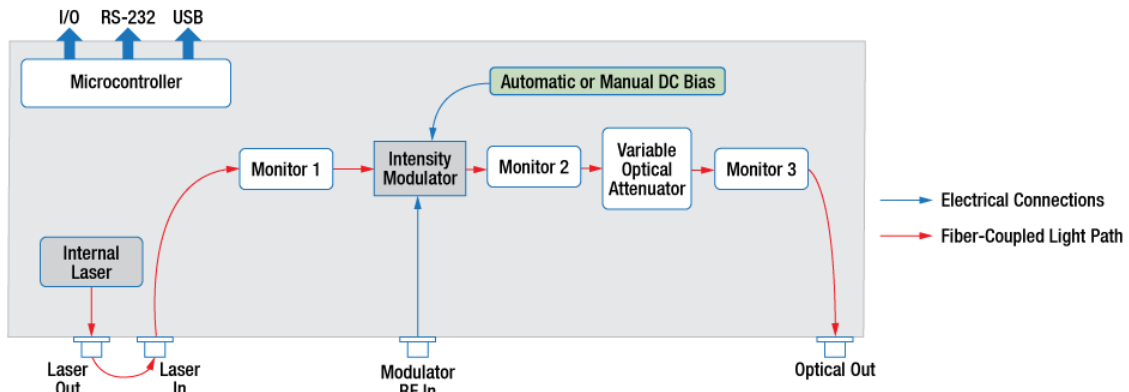

Note: The MN4775A-0040 850 nm E/O Converter does not have an external jumper for the optical path.

**36585-Series Automatic Calibrators (AutoCal)**

The 36585-Series Precision Automatic Calibrator (AutoCal) Module provides industry-leading performance in corrected characteristics using over-determined algorithms, and transferring characteristics from a highly accurate LRL type calibration. The resulting accuracies will even out perform a Sliding Load SOLT calibration. In order to remove the effects of matched adapters, the Precision 36585-Series AutoCal comes in a variety of connector gender types (m-m, f-f, and m-f). Adapter Removal Calibration routine is still available in the VectorStar software. With coverage from 70 kHz to 70 GHz, the 36585-series Precision AutoCal offers not only the fastest and most reliable calibration, but also the most accurate broadband coaxial VNA calibration method.



36585V Series Precision AutoCal Module

36585 Series Precision AutoCal Calibration Kit

Description	Additional Information	Part Number
Precision AutoCal, K 70 kHz to 40 GHz, 2-port	K (male) to K (male)	36585K-2M
	K (female) to K (female)	36585K-2F
	K (male) to K (female)	36585K-2MF
Precision AutoCal, V 70 kHz to 70 GHz, 2-port	V (male) to V (male)	36585V-2M
	V (female) to V (female)	36585V-2F
	V (male) to V (female)	36585V-2MF

**AutoCal General and Environmental**

36581-Series Dimensions	65 mm H x 155 mm W x 90 mm D body (excluding connectors)
36585-Series Dimensions	42 mm H x 64 mm W x 140 mm D body (excluding connectors)
Control	Serial RS-232 control by the VNA via supplied 9-pin D-Sub cable (allowing forward-compatibility to legacy AutoCal)
Power	DC powered via supplied universal 110/220 V AC/DC adapter (with enough power to maintain optimum stability)
Operating Temperature	18 to 28 °C
Storage Temperature	-20 to 70 °C
Relative Humidity	5 % to 95 % at 40 °C, Non-condensing
EMI	Conforms to and meets the requirements of:
EMC Directive	2004/108/EC
Low Voltage Directive	2006/95/EC
Emissions	EN55011:2009+A1:2010 Group 1 Class A
Immunity	EN 61000-4-2:2009, 4 kV CD, 8 kV AD EN 61000-4-3:2006+A2:2010, 3 V/m EN 61000-4-4:2004, 0.5 kV S-L, 1 kV P-L EN 61000-4-5:2006, 0.5 kV S-L, 1 kV L-E EN 61000-4-6:2009, 3 V EN 61000-4-11:2004, 100 % @ 20 ms

## Mechanical Calibration Kits

### SMA/3.5 mm Calibration Kit, 3650A Series

3650A cal kit provides 50  $\Omega$  calibrations for 3.5 mm or SMA devices using 3.5 mm standards. 3650A-1 cal kit includes Sliding Loads.

<b>3650A Cal Kit contains:</b>	<b>Additional Information (typical)</b>	<b>Quantity</b>	<b>Part Number</b>
Termination 3.5 mm (male)	Return Loss: > 37 dB (F $\leq$ 18.5 GHz)	2	28S50-2
Termination 3.5 mm (female)	> 30 dB (F > 18.5 GHz)	2	28SF50-2
Open 3.5 mm (male)	Offset: 5 mm	1	24S50
Open 3.5 mm (female)	Offset: 5 mm	1	24SF50
Short 3.5 mm (male)	Offset: 5 mm	1	23S50
Short 3.5 mm (female)	Offset: 5 mm	1	23SF50
Adapter, 3.5 mm (male) to 3.5 mm (male)		1	33SS50
Adapter, 3.5 mm (female) to 3.5 mm (female)		2	33SFSF50
Adapter, 3.5 mm (male) to 3.5 mm (female)		2	33SSF50
Torque Wrench	5/16 in, 0.9 N·m (8 lbf·in)	1	01-201
Wrench, Universal	For SMA, 3.5 mm, 2.4 mm, K and V Connectors	1	01-204
Pin Depth Gauge		1	01-222
Adapter (female) for Pin Gauge		1	01-223
Reference Flat		1	01-210
Connector Thumb Wheel		4	A18311
Coefficients for standards	Provided on a memory device and 3.5 in floppy disk	1	-
<b>3650A-1 Cal Kit adds:</b>	<b>Additional Information (typical)</b>	<b>Quantity</b>	<b>Part Number</b>
Sliding Termination 3.5 mm (male)		1	17S50
Sliding Termination 3.5 mm (female)		1	17SF50
Flush Short (male)		1	01-211
Flush Short (female)		1	01-212

### K (2.92 mm) Calibration Kit, 3652A Series

3652A cal kit provides 50  $\Omega$  calibrations for K devices.

<b>3652A Cal Kit contains:</b>	<b>Additional Information (typical)</b>	<b>Quantity</b>	<b>Part Number</b>
Termination K (male)	Return Loss: > 34 dB (F $\leq$ 18.5 GHz)	2	28K50A
Termination K (female)	> 32 dB (F $\leq$ 40 GHz)	2	28KF50A
Open K (male)	Offset: 5 mm	1	24K50
Open K (female)	Offset: 5 mm	1	24KF50
Short K (male)	Offset: 5 mm	1	23K50
Short K (female)	Offset: 5 mm	1	23KF50
Adapter, K (male) to K (male)		1	33KK50B
Adapter, K (female) to K (female)		2	33KFKF50B
Adapter, K (male) to K (female)		2	33KKF50B
Torque Wrench	5/16 in, 0.9 N·m (8 lbf·in)	1	01-201
Wrench, Universal	For SMA, 3.5 mm, 2.4 mm, K, and V Connectors	1	01-204
Pin Depth Gauge		1	01-222
Adapter (female) for Pin Gauge		1	01-223
Reference Flat		1	01-210
Connector Thumb Wheel		4	A18311
Coefficients for standards	Provided on a USB memory device and 3.5 in floppy disk	1	-

**Mechanical Calibration Kits** (continued)

**K (2.92 mm) Calibration Kit, 3652A Series (continued)**

	: Additional Information (typical)	Quantity	Part Number
<b>3652A-2 Cal Kit adds:</b>			
No Additional Options		NA	NA
Removes Pin Depth Gauge		NA	01-222
Removes Female Adapter for Pin Depth Gauge		NA	01-223
Removes Reference Flat		NA	01-210
<b>3652A-3 Cal Kit adds:</b>			
.s1p Characterization		1	NA
<b>3652A-4 Cal Kit adds:</b>			
.s1p Characterization		1	NA
Removes Pin Depth Gauge		NA	01-222
Removes Female Adapter for Pin Depth Gauge		NA	01-223
Removes Reference Flat		NA	01-210

**V (1.85 mm) Calibration Kit, 3654D Series**

3654D cal kit provides 50 Ω calibrations for V devices.

	<b>3654D Cal Kit contains:</b>	<b>Additional Information (typical)</b>	<b>Quantity</b>	<b>Part Number</b>
	Termination V (male)	Return Loss: > 40 dB (F ≤ 20 GHz); > 35 dB (F ≤ 40 GHz)	2	28V50D
	Termination V (female)	> 32 dB (F ≤ 67 GHz); > 28 dB (F ≤ 70 GHz)	2	28VF50D
	Open V (male)	Offset: 4.75 mm	1	24V50C
	Open V (female)	Offset: 4.75 mm	1	24VF50C
	Short V (male)	Offset: 5.1 mm	1	23V50C
	Short V (female)	Offset: 5.1 mm	1	23VF50C
	Adapter, V (male) to V (male)		1	33VV50C
	Adapter, V (female) to V (female)		2	33VVF50C
	Adapter, V (male) to V (female)		2	33VVF50C
	Torque Wrench	5/16 in, 0.9 N·m (8 lbf·in)	1	01-201
	Wrench, Universal	For SMA, 3.5 mm, 2.4 mm, K, and V Connectors	1	01-204
	Pin Depth Gauge		1	01-322
	Adapter (female) for Pin Gauge		1	01-323
	Reference Flat		1	01-210
	Connector Thumb Wheel		4	A18311
	Coefficients for standards	Provided on a USB memory device and 3.5 in floppy disk	1	-
	<b>3654D-2 Cal Kit adds:</b>		<b>Quantity</b>	<b>Part Number</b>
	No Additional Options		NA	NA
	Removes Pin Depth Gauge		NA	01-322
	Removes Female Adapter for Pin Depth Gauge		NA	01-323
	Removes Reference Flat		NA	01-210
	<b>3654D-3 Cal Kit adds:</b>		<b>Quantity</b>	<b>Part Number</b>
	.s1p Characterization		1	NA
	<b>3654D-4 Cal Kit adds:</b>		<b>Quantity</b>	<b>Part Number</b>
	.s1p Characterization		1	NA
	Removes Pin Depth Gauge		NA	01-322
	Removes Female Adapter for Pin Depth Gauge		NA	01-323
	Removes Reference Flat		NA	01-210



3654D Series, V (1.85 mm) Calibration Kit



**V (1.85 mm) Multi-Line Calibration Kit, 3657 Series**

The 3657 Calibration Kit provides 50 Ω beadless V (male to male) lines for metrology applications. The 3657-1 Calibration Kit includes Shorts for LRL-type coaxial calibrations.

<b>3657 Cal Kit contains:</b>		<b>Additional Information (typical)</b>		<b>Quantity</b>	<b>Part Number</b>
Line 1	Electrical Length = 15 mm; 50 Ω	Center Conductor		1	65899-1
		Outer Conductor		1	65898-1
Line 2	Electrical Length = 16.7 mm; 50 Ω	Center Conductor		1	65899-2
		Outer Conductor		1	65898-2
Line 3	Electrical Length = 18.4 mm; 50 Ω	Center Conductor		1	65899-3
		Outer Conductor		1	65898-3
Line 4	Electrical Length = 20.1 mm; 50 Ω	Center Conductor		1	65899-4
		Outer Conductor		1	65898-4
Line 5	Electrical Length = 21.8 mm; 50 Ω	Center Conductor		1	65899-5
		Outer Conductor		1	65898-5
Line 6	Electrical Length = 49.84 mm; 50 Ω	Center Conductor		1	65899-6
		Outer Conductor		1	65898-6
Tool, Center Conductor Removal Plug				1	65922
Fixture, Center Conductor Installation, Short		For Lines 1 to 5		1	65901-1
Fixture, Center Conductor Installation, Long		For Line 6		1	65901-6
Open-Ended Wrench		7 mm		1	783-1243
Torque Wrench		5/16 in, 0.9 N·m (8 lbf·in)		1	01-201
<b>3657-1 Cal Kit adds:</b>		<b>Additional Information (typical)</b>		<b>Quantity</b>	<b>Part Number</b>
Short V (male)		Offset: 5.1 mm		2	23V50B
Short V (female)		Offset: 5.1 mm		2	23VF50B



3657 Series, V (1.85 mm) Multi-Line Calibration Kit

## Verification Kits

Verification kits include characterized traceable standards (two attenuators, an airline, and a stepped impedance airline Beatty Standard) that can be used with the provided Performance Verification Software (PVS) and data to verify the calibration and resulting performance of your VNA.

The applicable calibrations are Short-Open-Load-Through (SOLT) with and without Sliding Loads for the 3666-1, 3668-1, and 3669B-1 Verification Kits. The verification kits are used with the 365x and 365x-1 Cal Kits, and 36585x Series AutoCal, male-female version. Cal Kits and AutoCal are purchased separately. These verification kits are dedicated for the MS4640B Series VNAs, and are not for older VNAs.

Verification is also provided as a service, eliminating the investment in kits.

### VectorStar MS4640B VNA Verification Kits

3666-1	SMA/3.5 mm Connector Verification Kit
3668-1	K Connector Verification Kit
3669B-1	V Connector Verification Kit



366X-X Verification Kit



Precision Adapters, Attenuators, and More

## Precision Adapters, Attenuators, and Other Components

Anritsu carries a complete line of precision adapters and attenuators. For more information, please visit our web site at [www.anritsu.com](http://www.anritsu.com).

Test Port Cables

**3670-Series Test Port Cables, Ruggedized Semi-Rigid, up to 70 GHz**

Note: Connector torque for 3670-Series cables is 8 lbf-in (0.9 N·m).

Description	Frequency Range	Nominal Impedance	Insertion Loss (dB, typical)	Return Loss (dB, typical)	Length	Part Number
K (female) to K (male)	DC to 40 GHz	50 Ω	2.3 dB/m @ 20 GHz	≥ 16	30.5 cm (12 in)	3670K50-1
			4.7 dB/m @ 40 GHz		61.0 cm (24 in)	3670K50-2
V (female) to V (male)	DC to 70 GHz	50 Ω	3.6 dB/m @ 20 GHz	≥ 16	30.5 cm (12 in)	3670V50A-1
			5.2 dB/m @ 40 GHz 7.2 dB/m @ 70 GHz		61.0 cm (24 in)	3670V50A-2



70 GHz Phase Stable Flexible Test Port Cables, 3671-Series



70 GHz Ruggedized Semi-Rigid Test Cables, 3670-Series

**3671-Series Test Port Cables, Flexible, Phase Stable, up to 70 GHz**

Note: Connector torque for 3671-Series cables is 8 lbf-in (0.9 N·m).

Description	Frequency Range	Nominal Impedance	Insertion Loss (dB, f in GHz)	Return Loss (dB)	Phase Stability (± degrees, f in GHz)	Length	Part Number
K (female) to 3.5 mm (male)	DC to 26.5 GHz	50 Ω	≤ 1.8	≥ 18	≤ ± 4.0 (1 coil)	60 cm (23.5 in)	3671KFS50-60
K (female) to K (male or female)	DC to 40 GHz	50 Ω	≤ 3.4	≥ 16	≤ ± 3.7 (1/2 coil)	60 cm (23.5 in)	3671KFK50-60
K (female) to K (male)	DC to 40 GHz	50 Ω	≤ 5.0	≥ 16	≤ ± 7.3 (1 coil)	100 cm (39.3 in)	3671KFK50-100
K (female) to K (female)	DC to 40 GHz	50 Ω	≤ 3.4	≥ 16	≤ ± 3.7 (1/2 coil)	60 cm (23.5 in)	3671KFKF50-60
V (female) to V (male)	DC to 70 GHz	50 Ω	≤ 6.0	≥ 14	≤ ± 8.5 (1/2 coil)	60 cm (23.5 in)	3671VfV50-60
V (female) to V (male)	DC to 70 GHz	50 Ω	≤ 9.3	≥ 14	≤ ± 10.5 (1 coil)	100 cm (39.3 in)	3671VfV50-100

## Universal Test Fixture (UTF)

The 3680-series UTF provide an accurate, repeatable solution for measuring microstrip and coplanar substrate devices.

- Input and output connections are made to the substrate device by two spring-loaded jaws that include coax-to-microstrip/coplanar launchers.
- One jaw is movable in two dimensions to accommodate substrates of different lengths and offsets.
- Right angle launchers are available for right angle devices.
- Microstrip calibration/verification kits are available for substrate thicknesses of 10 mil (60 GHz), 15 mil (30 GHz), and 25 mil (20 GHz).
- A coplanar waveguide calibration/verification kit is also available.

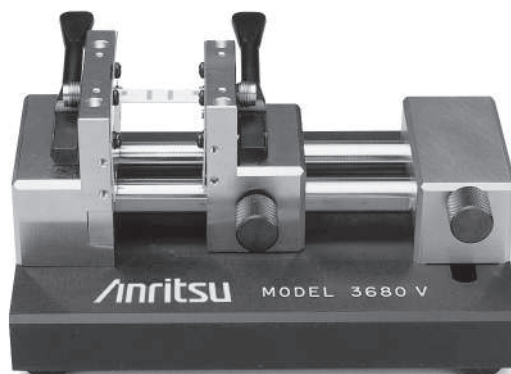

3680 Series Universal Test Fixture (UTF)

### UTF Electrical Specifications

Type	Frequency Range (GHz)	Return Loss (dB)	Repeatability (dB)	Frequency Coverage	Part Number
UTF	DC to 20	> 17	< 0.10	DC to 20 GHz	3680-20
	20 to 40	> 14	< 0.20	DC to 40 GHz	3680K
	40 to 60	> 8	< 0.30	DC to 60 GHz	3680V
Right Angle Launcher	DC to 20	> 16	< 0.15	DC to 40 GHz	36801K
	20 to 40	> 12	< 0.25	DC to 60 GHz	36801V
	40 to 60	> 7	< 0.40		

### UTF General Information

Substrate Length	3680-20, 0.5 cm (min) to 10 cm (max) 3680K, 0.5 cm (min) to 5 cm (max) 3680V, 0.5 cm (min) to 5 cm (max)
Maximum Substrate Width	All UTF models, No Limit
Substrate Thickness	All UTF models, 0.12 mm (min), 1.9 mm (max)
Maximum Line Offset	3680-20, ± 2.5 cm 3680K, ± 1.2 cm 3680V, ± 1.2 cm
Input and Output Connectors	3680-20, 3.5 mm (females) 3680K, K (females) 3680V, V (females)
Overall Size	All UTF models, 10 cm x 12.7 cm x 6.4 cm

### UTF Right Angle Launcher

Distance from in-line connector, axial	All UTF models, 1 cm (min), 4 cm (max)
Distance from in-line connector, offset	All UTF models, 0 cm (min), 2 cm (max)

## Ordering Information

<b>Instrument Models</b>	The VectorStar MS4640B Series VNAs are available to meet different frequency range requirements. Refer to “Standard Capabilities” for extended operational frequency ranges.
MS4642B	Vector Network Analyzer 10 MHz to 20 GHz (Minimum configuration requires one of Options 61 or 62)
MS4644B	Vector Network Analyzer 10 MHz to 40 GHz
MS4647B	Vector Network Analyzer 10 MHz to 70 GHz
<b>Included Accessories</b>	Each VNA comes with a set of included accessories.
Online Help	The instrument is equipped with context-sensitive help built from the VectorStar Operation Manual, User Interface Reference Manual, Programming Manual, Programming Manual Supplement, and Calibration and Measurement Guide.
Peripherals	Optical USB Mouse
Power	Power Cord
<b>Main VNA Options</b>	
MS4640B-001	Rack Mount, adds handles and removes feet for shelf-mounting into a 19” universal rack
MS4640B-002	Time Domain
MS4640B-004	Additional Serial-ATA (SATA) Solid State Drive (SSD) with OS and VectorStar Application Software
MS4640B-007	Receiver Offset
MS4640B-021	Universal Fixture Extraction
MS464xB-031	Dual Source Architecture
MS464xB-032	Internal RF Combiner, requires Option 31
MS4640B-035	IF Digitizer
MS4640B-036	Extended IF Digitizer Memory
MS4640B-041	Noise Figure, requires Option 51 or Option 61 or Option 62
MS4640B-042	PulseView™, requires Option 35
MS4640B-043	DifferentialView™
MS4640B-044	IMDView™
MS4640B-046	Fast CW
MS4640B-047	Eye Diagram, requires Option 2
MS4640B-048	Differential Noise Figure, requires Option 51 or Option 61 or Option 62
MS464xB-051	Direct Access Loops, see description below
MS464xB-053	External ALC
MS464xB-061/062	Active Measurement Suite options, see description below
MS4640B-070	70 kHz Low-End Frequency Extension
<b>Direct Access Loop Options</b>	Note: Direct access loops are not available for VNAs equipped with Option 61 or 62, which include loops.
MS4644B-051	Direct Access Loops for MS4644B, not available with Option 61 or 62
MS4647B-051	Direct Access Loops for MS4647B, not available with Option 61 or 62
<b>Active Measurement Suite Options</b>	
MS4642B-061	Active Measurements Suite, For MS4642B with 2 Step Attenuators
MS4642B-062	Active Measurements Suite, For MS4642B with 4 Step Attenuators
MS4644B-061	Active Measurements Suite, For MS4644B, with 2 Step Attenuators
MS4644B-062	Active Measurements Suite, For MS4644B, with 4 Step Attenuators
MS4647B-061	Active Measurements Suite, For MS4647B, with 2 Step Attenuators
MS4647B-062	Active Measurements Suite, For MS4647B, with 4 Step Attenuators
<b>Pulse Modulator Test Sets</b>	
SM6628	Pulse Modulator Test Set, 70 kHz to 40 GHz, for source modulation with an MS4642B or MS4644B
SM6629	Pulse Modulator Test Set, 70 kHz to 40 GHz, for source and receiver modulation with an MS4642B or MS4644B
SM6630	Pulse Modulator Test Set, 70 kHz to 70 GHz, for source modulation with an MS4647B
SM6631	Pulse Modulator Test Set, 70 kHz to 70 GHz, for source and receiver modulation with an MS4647B
<b>Multipoint VNA Options</b>	The multipoint VNA option provides four test ports for all VectorStar MS4640B Series VNAs with the MN469xC Series Multipoint Test Sets. The option provides the Test Set, necessary cabling, and installation documentation. The Test Set frequency range is limited to that of the attached VNA.
MN4694C	70 kHz to 40 GHz, Use the MN4694C Test Set with MS4642B and MS4644B VNAs
MN4697C	70 kHz to 70 GHz, Use the MN4697C Test Set with MS4647B VNAs
Documentation	For detailed MN469xC specifications, refer to the VectorStar MN469xC Series Multipoint VNA Technical Data Sheet – 11410-00777

**Broadband/Banded/Millimeter-Wave Systems** For details on the MS464xB-08x series of options, see the:

11410-00593	VectorStar ME7838A Modular Broadband/Millimeter-Wave Technical Data Sheet
11410-00778	VectorStar ME7838D Modular Broadband/Millimeter-Wave Technical Data Sheet
11410-00767	VectorStar ME7838E Modular Broadband/Millimeter-Wave Technical Data Sheet
11410-01060	VectorStar ME7838G Modular Broadband/Millimeter-Wave Technical Data Sheet
11410-00704	VectorStar ME7838A4 4-Port Modular Broadband/Millimeter-Wave Technical Data Sheet
11410-01099	VectorStar ME7838D4 4-Port Modular Broadband/Millimeter-Wave Technical Data Sheet
11410-01100	VectorStar ME7838E4 4-Port Modular Broadband/Millimeter-Wave Technical Data Sheet

**Calibration Options**

MS4640B-097	Accredited Calibration, With Data
MS4640B-098	Z540/Guide 25 Calibration, No Data
MS4640B-099	Premium Calibration, With Data

**E/O Converter Module**

MN4775A-0040	Configured for 70 kHz to 40 GHz range, with 850 nm wavelength coverage
MN4775A-0070	Configured for 70 kHz to 40 GHz range, with 1550 nm wavelength coverage
MN4775A-0071	Configured for 70 kHz to 40 GHz range, with 1310 nm wavelength coverage

**O/E Calibration Module**

MN4765B-0040	Configured for 70 kHz to 40 GHz range, with 850 nm wavelength coverage
MN4765B-0042	Configured for 70 kHz to 40 GHz range, with 850 and 1060 nm wavelength coverage
MN4765B-0043	Configured for 70 kHz to 40 GHz range, with 850/1060/1310/1550 nm wavelength coverage
MN4765B-0070	Configured for 70 kHz to 70 GHz range, with 1550 nm wavelength coverage
MN4765B-0071	Configured for 70 kHz to 70 GHz range, with 1310 nm wavelength coverage
MN4765B-0072	Configured for 70 kHz to 70 GHz range, with 1310 and 1550 nm wavelength coverage.
MN4765B-0110	Configured for 70 kHz to 110 GHz range, with 1550 nm wavelength coverage.

**Precision Automatic Calibrator Modules (Precision AutoCal)**

36585K-2M	K Precision AutoCal Module, 70 kHz to 40 GHz, K (male) to K (male)
36585K-2F	K Precision AutoCal Module, 70 kHz to 40 GHz, K (female) to K (female)
36585K-2MF	K Precision AutoCal Module, 70 kHz to 40 GHz, K (male) to K (female)
36585V-2M	V Precision AutoCal Module, 70 kHz to 70 GHz, V (male) to V (male)
36585V-2F	V Precision AutoCal Module, 70 kHz to 70 GHz, V (female) to V (female)
36585V-2MF	V Precision AutoCal Module, 70 kHz to 70 GHz, V (male) to V (female)

**Mechanical Calibration Kits**

3650A	SMA/3.5 mm Calibration Kit, Without Sliding Loads
3650A-1	SMA/3.5 mm Calibration Kit, With Sliding Loads
3652A	K Calibration Kit, With Pin Depth Gauge
3652A-2	K Calibration Kit, With No Pin Depth Gauge
3652A-3	K Calibration Kit, With Pin Depth Gauge and .s1p Characterization Files
3652A-4	K Calibration Kit, With .s1p Characterization Files
3654D	V Calibration Kit, With Pin Depth Gauge
3654D-2	V Calibration Kit With No Pin Depth Gauge
3654D-3	V Calibration Kit, With Pin Depth Gauge and .s1p Characterization Files
3654D-4	V Calibration Kit, With .s1p Characterization Files and No Pin Depth Gauge
3657	V Multi-Line Calibration Kit, Without Shorts
3657-1	V Multi-Line Calibration Kit, With Shorts

**Verification Kits**

3666-1	SMA/3.5 mm Verification Kit
3668-1	K Verification Kit
3669B-1	V Verification Kit

**External Power Meters/Sensors**

ML243xA	CW Power Meter, Single Input or Dual Input Recommended Power Sensors: SC7770, MA247xD, MA244xD, MA248xD, MA2400xA
ML248xB	Wideband Power Meter, Single Input or Dual Input Recommended Power Sensors: MA249xA, MA2411B
ML249xA	Pulse Power Meter, Single Input or Dual Input Recommended Power Sensors: MA249xA, MA2411B
MA24106A	USB Power Sensor, 50 MHz to 6 GHz
MA24108A	USB Power Sensor, 10 MHz to 8 GHz
MA24118A	USB Power Sensor, 10 MHz to 18 GHz
MA24126A	USB Power Sensor, 10 MHz to 26 GHz
MA24208A	USB Power Sensor, True-RMS, 10 MHz to 8 GHz
MA24218A	USB Power Sensor, True-RMS, 10 MHz to 18 GHz
MA24330A	USB Power Sensor, 10 MHz to 33 GHz
MA24340A	USB Power Sensor, 10 MHz to 40 GHz
MA24350A	USB Power Sensor, 10 MHz to 50 GHz
MA24507A	Power Master™ Frequency Selectable mm-Wave Power Analyzer, 9 kHz to 70 GHz
MA24510A	Power Master™ Frequency Selectable mm-Wave Power Analyzer, 9 kHz to 110 GHz

Note that usage of the MA24507A and MA24510A Power Master™ sensors require connection to two USB ports to supply needed current draw.

**Test Port Cables, Ruggedized Semi-Rigid**

3670K50-1	Test Port Cable, K (female) to K (male), 1 each, 30.5 cm (12 in)
3670K50-2	Test Port Cable, K (female) to K (male), 1 each, 61.0 cm (24 in)
3670V50A-1	Test Port Cable, V (female) to V (male), 1 each, 30.5 cm (12 in), rated to 70 GHz
3670V50A-2	Test Port Cable, V (female) to V (male), 1 each, 61.0 cm (24 in), rated to 70 GHz

**Test Port Cables, Flexible, Ruggedized-Style Female Connectors, Phase Stable**

Ruggedized style female connectors for VNA test ports.

3671KFS50-60	K (female) to 3.5 mm (male), 1 each 63.5 cm (25 in) Note: Due to length, two (2) cables are required for each system
3671KFK50-60	K (female) to K (male), 1 each, 63.5 cm (25 in) Note: Due to length, two (2) cables are required for each system
3671KFK50-100	K (female) to K (male), 1 each, 96.5 cm (38 in)
3671KFKF50-60	K (female) to K (female), 1 each 63.5 cm (25 in) Note: Due to length, two (2) cables are required for each system
3671KFK50-60	K (female) to K (male), 1 each 63.5 cm (25 in) Note: Due to length, two (2) cables are required for each system
3671VVF50-60	V (female) to V (male), 1 each, 63.5 cm (25 in), rated to 70 GHz Note: Due to length, two (2) cables are required for each system
3671VVF50-100	V (female) to V (male), 1 each 96.5 cm (38 in), rated to 70 GHz

**Test Port Converters** To change or replace VNA test ports.

34YK50C	Universal Test Port Connector to K (male), Installation requires wrench 01-202 (not included)
34YV50C	Universal Test Port Connector to V (male), Installation requires wrench 01-202 (not included)
34YS50A	Universal Test Port Connector to 3.5 mm (male), Installation requires wrench 01-202 (not included)
34YQ50A	Universal Test Port Connector to 2.4 mm (male), Installation requires wrench 01-202 (not included)

**Universal Test Fixture (UTF)**

3680-20	UTF, DC to 20 GHz
3680K	UTF, DC to 40 GHz
3680V	UTF, DC to 60 GHz
36801K	UTF Right Angle Launcher, DC to 30 GHz
36801V	UTF Right Angle Launcher, DC to 50 GHz
36803	Bias Probe
36804B-10M	Microstrip Calibration/Verification Kit, 10 mil, DC to 50 GHz
36804B-15M	Microstrip Calibration/Verification Kit, 15 mil, DC to 30 GHz
36804B-25M	Microstrip Calibration/Verification Kit, 25 mil, DC to 15 GHz

**Precision Fixed Attenuators, Adapters (in and out of series, waveguide to coaxial), and more**

Refer to our extensive Precision RF & Microwave Components Catalog – 11410-00235

**GPIB Cables**

2100-5	GPIB Cable, 0.5 m long
2100-1	GPIB Cable, 1 m long
2100-2	GPIB Cable, 2 m long
2100-4	GPIB Cable, 4 m long

**Transit Case**

760-267-R Transit Case, for all MS4640B Series VNAs, Hard plastic with wheels, 85 cm x 70 cm x 45 cm

**Tools**

01-201 Torque End Wrench, 5/16 in, 0.9 N·m (8 lbf·in),  
For tightening male devices, For SMA, 3.5 mm, 2.4 mm, K, and V connectors.

01-202 Torque End Wrench, 1/2 in, 60 lbf·in,  
For servicing the universal test port, For the removal or installation of a test port.

01-203 Torque End Wrench, 20.6 mm (13/16 in), 0.9 N·m (8 lbf·in),  
For tightening the VNA test ports to female devices.

01-204 End Wrench, 5/16 in, Universal, Circular, Open-ended,  
For SMA, 3.5 mm, 2.4 mm, K and V connectors.

01-504 Torque End Wrench, 6 mm, 0.45 N·m (4 lbf·in),  
For tightening 1 mm connectors.

01-505 6 mm × 7 mm Open End Wrench,  
Backing wrench for 6 mm torque wrench above for 1 mm connectors.

01-529-R Torque End Wrench, 4 mm (5/32 in), 0.17 N·m (1.5 lbf·in),  
For tightening the SSMC TEST and REF connectors on mm-Wave Modules.

**Documentation**

User Documentation: All manuals are available as free downloads at [www.anritsu.com](http://www.anritsu.com).  
Printed manuals in 3-ring binders are available for a nominal charge.

10410-00317 MS4640B Series VNA Operation Manual (OM)

10410-00318 MS4640B Series VNA Calibration and Measurement Guide (MG)

10410-00319 MS4640B Series VNA User Interface Reference Manual (UIRM)

10410-00320 MS4640B Series VNA Maintenance Manual (MM)

10410-00322 MS4640B Series VNA Programming Manual (PM), for IEEE 488.2, System, and SCPI Commands

10410-00323 MS4640B Series VNA Programming Manual Supplement (PMS), for Lightning 37xxxx and HP8510 Emulation



**Extended Service Options**

Use the table below to select the service location, service period, type of service, and the VectorStar instrument model number.

Service Location	Service Period	Type of Service	VNA Model	Part Number
On-Site	3 Years	Repair Only	MS4642B	MS4642B-ES311
			MS4644B	MS4644B-ES311
			MS4647B	MS4647B-ES311
On-Site	3 Years	Standard Calibration	MS4642B	MS4642B-ES314
			MS4644B	MS4644B-ES314
			MS4647B	MS4647B-ES314
On-Site	3 Years	Premium Calibration	MS4642B	MS4642B-ES318
			MS4644B	MS4644B-ES318
			MS4647B	MS4647B-ES318
Service Center	3 Years	Standard Calibration	MS4642B	MS4642B-ES312
			MS4644B	MS4644B-ES312
			MS4647B	MS4647B-ES312
Service Center	3 Years	Premium Calibration	MS4642B	MS4642B-ES315
			MS4644B	MS4644B-ES315
			MS4647B	MS4647B-ES315
Service Center	5 Years	Repair Only	MS4642B	MS4642B-ES510
			MS4644B	MS4644B-ES510
			MS4647B	MS4647B-ES510
Service Center	5 Years	Standard Calibration	MS4642B	MS4642B-ES512
			MS4644B	MS4644B-ES512
			MS4647B	MS4647B-ES512
Service Center	5 Years	Premium Calibration	MS4642B	MS4642B-ES515
			MS4644B	MS4644B-ES515
			MS4647B	MS4647B-ES515
Service Center	5 Years	Repair and Standard Calibration	MS4642B	MS4642B-ES513
			MS4644B	MS4644B-ES513
			MS4647B	MS4647B-ES513
Service Center	5 Years	Repair and Premium Calibration	MS4642B	MS4642B-ES516
			MS4644B	MS4644B-ES516
			MS4647B	MS4647B-ES516

**Post-Delivery Upgrade Options**

If your needs change, it's reassuring to know that your Anritsu product can grow with you. Contact your local Anritsu service center for adding internal options or increasing the frequency coverage of your existing MS4640B Series VNA.

Notes

## Training at Anritsu

Anritsu has designed courses to help you stay up to date with technologies important to your job. For available training courses, visit: [www.anritsu.com/training](http://www.anritsu.com/training)



### • United States

**Anritsu Americas Sales Company**  
450 Century Parkway, Suite 190  
Allen, TX 75013, U.S.A.  
Phone: +1-800-Anritsu (1-800-267-4878)

### • Canada

**Anritsu Electronics Ltd.**  
700 Silver Seven Road, Suite 120  
Kanata, Ontario K2V 1C3, Canada  
Phone: +1-613-591-2003  
Fax: +1-613-591-1006

### • Brazil

**Anritsu Eletronica Ltda.**  
Praça Amadeu Amaral, 27 - 1 Andar  
01327-010 - Bela Vista - Sao Paulo - SP  
Brazil  
Phone: +55-11-3283-2511  
Fax: +55-11-3288-6940

### • Mexico

**Anritsu Company, S.A. de C.V.**  
Blvd Miguel de Cervantes Saavedra #169 Piso 1,  
Col. Granada  
Mexico, Ciudad de Mexico, 11520, MEXICO  
Phone: +52-55-4169-7104

### • United Kingdom

**Anritsu EMEA L td.**  
200 Capability Green  
Luton, Bedfordshire, LU1 3LU, U.K.  
Phone: +44-1582-433200  
Fax: +44-1582-731303

### • France

**Anritsu S.A.**  
12 avenue du Québec, Bâtiment Iris 1- Silic 612,  
91140 Villebon-sur-Yvette, France  
Phone: +33-1-60-92-15-50  
Fax: +33-1-64-46-10-65

### • Germany

**Anritsu GmbH**  
Nemetschek Haus, Konrad-Zuse-Platz 1  
81829 München, Germany  
Phone: +49-89-442308-0  
Fax: +49-89-442308-55

### • Italy

**Anritsu S.r.l.**  
Via Elio Vittorini 129, 00144 Roma, Italy  
Phone: +39-6-509-9711  
Fax: +39-6-502-2425

List Revision Date: 20181114

### • Sweden

**Anritsu AB**  
Isafjordsgatan 32C  
164 40 Kista, Sweden  
Phone: +46-8-534-707-00

### • Finland

**Anritsu AB**  
Teknobulevardi 3-5  
FI-01530 Vantaa, Finland  
Phone: +358-20-741-8100  
Fax: +358-20-741-8111

### • Denmark

**Anritsu A/S**  
Torveporten 2  
2500 Valby, Denmark  
Phone: +45-7211-2200  
Fax: +45-7211-2210

### • Russia

**Anritsu EMEA Ltd.**  
**Representation Office in Russia**  
Tverskaya str. 16/2, bld. 1, 7th floor  
Moscow 125009, Russia  
Phone: +7-495-363-1694  
Fax: +7-495-935-8962

### • Spain

**Anritsu EMEA Ltd.**  
**Representation Office in Spain**  
Paseo de la Castellana, 141. Planta 5  
Edificio Cuzco IV  
28046 Madrid, Spain  
Phone: +34-915-726-761  
Fax: +34-915-726-621

### • United Arab Emirates

**Anritsu EMEA Ltd.**  
**Dubai Liaison Office**  
902 Aurora Tower  
P O Box: 500311 - Dubai Internet City  
Dubai, United Arab Emirates  
Phone: +971-4-3758479  
Fax: +971-4-4249036

### • India

**Anritsu India Private Limited**  
6th Floor, Indiqube ETA, No.38/4  
Adjacent to EMC2, Doddanekundi, Outer Ring Road  
Bengaluru 560048, India  
Phone: +91-80-6728-1300  
Fax: +91-80-6728-1301

### • Singapore

**Anritsu Pte. Ltd.**  
11 Chang Charn Road, #04-01, Shriro House  
Singapore 159640  
Phone: +65-6282-2400  
Fax: +65-6282-2533

### • P.R. China (Shanghai)

**Anritsu (China) Co., Ltd.**  
Room 2701-2705, Tower A  
New Caohejing International Business Center  
No. 391 Gui Ping Road  
Shanghai 200233, P.R. China  
Phone: +86-21-6237-0898  
Fax: +86-21-6237-0899

### • P.R. China (Hong Kong)

**Anritsu Company Ltd.**  
Unit 1006-7, 10/F.  
Greenfield Tower, Concordia Plaza  
No. 1 Science Museum Road  
Tsim Sha Tsui East, Kowloon  
Hong Kong, P.R. China  
Phone: +852-2301-4980  
Fax: +852-2301-3545

### • Japan

**Anritsu Corporation**  
8-5, Tamura-cho, Atsugi-shi, Kanagawa, 243-0016  
Japan  
Phone: +81-46-296-6509  
Fax: +81-46-225-8352

### • South Korea

**Anritsu Corporation, Ltd.**  
5FL, 235 Pangyoyeok-ro  
Bundang-gu, Seongnam-si  
Gyeonggi-do 13494, South Korea  
Phone: +82-31-696-7750  
Fax: +82-31-696-7751

### • Australia

**Anritsu Pty. Ltd.**  
Unit 20, 21-35 Ricketts Road  
Mount Waverley, Victoria 3149, Australia  
Phone: +61-3-9558-8177  
Fax: +61-3-9558-8255

### • Taiwan

**Anritsu Company Inc.**  
7F, No. 316, Sec. 1, NeiHu Rd, Taipei 114, Taiwan  
Phone: +886-2-8751-1816  
Fax: +886-2-8751-1817