

**Anritsu** envision : ensure

**VectorStar™**

High Performance, Broadband Network Analysis Solutions

# ME7838A4 4-Port Broadband Vector Network Analyzers

Broadband VNA System

70 kHz to 110 (125) GHz

Millimeter Waveguide VNA System

50 GHz to 1.1 THz

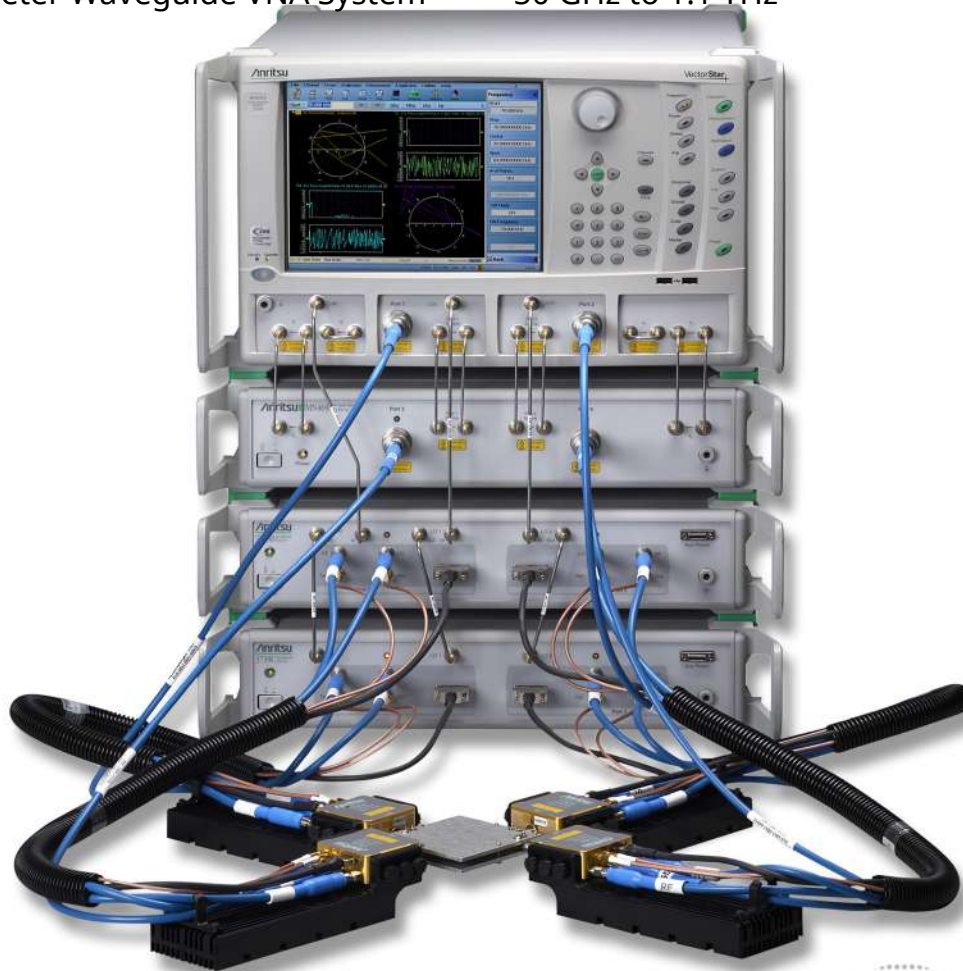

### 4-Port Broadband VNA System 70 kHz to 110 (125) GHz

The VectorStar ME7838A4 system incorporates the Anritsu millimeter-wave module utilizing Non Linear Transmission Line (NLTL) technology with single sweep 4-port coverage from 70 kHz to 110 GHz and provides:

- Industry-best broadband frequency coverage – starts at 70 kHz instead of 10 MHz and is operational from 40 kHz to 125 GHz.
- Industry-best calibration and measurement stability – 0.1 dB vs 0.6 dB over 24 hrs.
- Industry-best compact, lightweight mmWave modules for easy, precise, and economical positioning on the wafer probe station – 0.6 vs 7.6 lb and 1/50 the volume.
- Thin film multipliers, receivers, and couplers at the test port, offering best raw directivity and providing excellent calibration and measurement stability.
- The industry's only available mmWave real time electronic power leveling – eliminates time-lagging software correction tables.
- Compatibility with all major probe stations.
- Kelvin bias tees for sense and force capabilities closely positioned to the DUT.
- Can be upgraded to a 4-port 145 GHz version with the addition of MA25300A modules.

### 4-Port Millimeter Waveguide VNA System 50 GHz to 1.1 THz

The ME7838A4 4-port millimeter-wave configuration provides waveguide output from 50 GHz to 1.1 THz in waveguide bands. The system can extend the broadband system or be configured to operate only as a waveguide system.

### Broadband/Millimeter-Wave System Options

- MS4640B-002 – Time Domain
- MS4640B-021 – Universal Fixture Extraction
- MS464xB-031 – Dual Source Architecture
- MS464xB-032 – Internal RF Combiner
- MS4640B-035 – IF Digitizer
- MS4640B-036 – Extended IF Digitizer Memory
- MS4640B-041 – Noise Figure
- MS4640B-042 – PulseView™
- MS4640B-043 – DifferentialView™
- MS4640B-044 – IMDView™
- MS4640B-046 – Fast CW
- MS4640B-047 – Eye Diagram
- MS4640B-048 – Differential Noise Figure
- MS464xB-051 – External VNA Direct Access Loops
- MS464xB-061 – Active Measurement Suite, with 2 Attenuators
- MS464xB-062 – Active Measurement Suite, with 4 Attenuators
- 3744A-Rx – 30 to 110 GHz mm-Wave Receiver for Noise Figure and mm-Wave Antenna Measurements
- 3744A-EE – 56 to 95 GHz WR-12 Waveguide Module
- 3744A-EW – 65 to 110 GHz WR-10 Waveguide Module
- SC8215 and SC7287 – Kelvin Bias Tees

A detailed color brochure available on the Anritsu web site provides descriptions and examples of the VectorStar family's features and benefits:

<https://www.anritsu.com/en-us/test-measurement/products/ms4640b-series>

Table of Contents

Definitions . . . . . 3  
 4-Port Broadband Characteristics . . . . . 4  
 Specifications for Waveguide Band Configuration . . . . . 13  
 VectorStar ME7838A4 Waveguide Bands . . . . . 21  
 Standard Capabilities for All Configurations . . . . . 25  
 Mechanical and Environmental . . . . . 25  
 Regulatory Compliance . . . . . 25  
 Warranty . . . . . 26  
 Calibration and Correction Capabilities . . . . . 26  
 Mechanical Calibration/Verification Kits . . . . . 27  
 Test Port Cables . . . . . 28  
 Precision Adapters, Attenuators, and Other Components . . . . . 28  
 Ordering Information . . . . . 29

Definitions

All specifications and characteristics apply under the following conditions, unless otherwise stated:

Warm-Up Time	After 90 minutes of warm-up time, where the instrument is left in the ON state.
Temperature Range	Over the 25 °C ± 5 °C temperature range.
Error-Corrected Specifications	For error-corrected specifications, over 23 °C ± 3 °C, with < 1 °C variation from calibration temperature. For error-corrected specifications are warranted and include guard bands, unless otherwise stated.
Typical Performance	“Typical” specifications describe expected, but not warranted, performance based on sample testing. Typical performance indicates the measured performance of an average unit and do not guarantee the performance of any individual product. “Typical” specifications do not account for measurement uncertainty and are shown in parenthesis, such as (-102 dB), or noted as Typical.
User Cables/Adapters	Specifications do not include effects of any user cables, adapters, fixtures or other structures attached to the instrument.
Discrete Spurious Responses	Specifications may exclude discrete spurious responses.
Internal Reference Signal	All specifications apply with internal 10 MHz Crystal Oscillator Reference Signal.
Characteristic Performance	Characteristic performance indicates a performance designed-in and verified during the design phase. It does include guard-bands and is not covered by the product warranty.
Below 300 kHz	All uncertainties below 300 kHz are typical.
Recommended Calibration Cycle	12 months
Interpolation Mode	All specifications are with Interpolation Mode Off.
Specifications Subject to Change	All specifications subject to change without notice. For the most current data sheet, please visit the Anritsu web site: <a href="http://www.anritsu.com">www.anritsu.com</a>

## 4-Port Broadband Characteristics

### ME7838A4 4-Port Broadband Hardware Configuration

The ME7838A4 4-port broadband VNA system provides single sweep coverage from 70 kHz to 110 GHz and is operational from 40 kHz to 125 GHz. It consists of the following items:

Broadband VNA	ME7838A Broadband VNA System with Option 51, 61, or 62
4-Port Test Set	MN4697C 2U 4-Port Test Set
mm-Wave Modules	3743A Millimeter-Wave Modules, 2 each (two incremental to the modules in the ME7838A)
Test Set	3736B Broadband Test Set with Cables
Test Set	3739C Broadband Test Set with Cables

### ME7838A4 Broadband/Millimeter-Wave System Options

The major ME7838A4 4-port broadband VNA system options are:

Option 2	MS4640B-002 – Time Domain
Option 21	MS4640B-021 – Universal Fixture Extraction
Option 31	MS464xB-031 – Dual Source Architecture
Option 32	MS464xB-032 – Internal RF Combiner
Option 35	MS4640B-035 – IF Digitizer
Option 36	MS4640B-036 – Extended IF Digitizer Memory
Option 41	MS4640B-041 – Noise Figure
Option 42	MS4640B-042 – PulseView™
Option 43	MS4640B-043 – DifferentialView™
Option 44	MS4640B-044 – IMDView™
Option 46	MS4640B-046 – Fast CW
Option 47	MS4640B-047 – Eye Diagram
Option 48	MS4640B-048 – Differential Noise Figure
Option 51	MS464xB-051 – External VNA Direct Access Loops
Option 61	MS464xB-061 – Active Measurement Suite, with 2 Attenuators
Option 62	MS464xB-062 – Active Measurement Suite, with 4 Attenuators
Bias Tees	SC8215 and SC7287 – Kelvin Bias Tees

### System and Receiver Dynamic Range, Noise Floor (Excludes localized spurious responses and crosstalk)

System Dynamic Range	System dynamic range is measured as the difference between maximum port power and the RMS noise floor in a 10 Hz bandwidth and no averaging (ports terminated).
Noise Floor	Noise floor is calculated as the difference between maximum rated port power and system dynamic range.
Receiver Dynamic Range	Receiver Dynamic Range is calculated as the difference between the receiver compression level and the noise floor at the appropriate port.
Normalizing Measurement	Normalizing measurement made with a through line connection, with its effects compensated for. The cables between the VNA and the 3743A modules are assumed to be the 806-206-R 1.85 mm cable (61 cm, 24 in long) or the 806-209-R 1.85 mm cable (91.5 cm, 36 in long). All values are typical.

Frequency Range	System Dynamic Range (dB) <sup>a,c</sup>		Receiver Dynamic Range (dB) <sup>a</sup>		Noise Floor (dBm) <sup>a</sup>	
	ME7838A4 Option 51	ME7838A4 Option 31/51	ME7838A4 Option 51	ME7838A4 Option 62	ME7838A4 Option 51	ME7838A4 Option 62
70 kHz to 300 kHz	76	78	78	79	-72	-73
> 0.3 to 2 MHz	86	88	94	94	-82	-81
> 2 to 10 MHz	100	102	106	105	-94	-92
> 0.01 to 2.5 GHz	111	115	115	115	-103	-101
> 2.5 to 24 GHz	96	97	114	114	-102	-100
> 24 to 54 GHz	90	91	114	113	-104	-103
> 54 to 60 GHz	112	112	122	122	-112	-112
> 60 to 65 GHz	108	108	117	117	-107	-107
> 65 to 80 GHz	108	108	120	120	-110	-110
> 80 to 85 GHz	110	110	123	123	-113	-113
> 85 to 90 GHz	108	108	121	121	-111	-111
> 90 to 95 GHz	112	112	121	121	-111	-111
> 95 to 100 GHz	108	108	117	117	-107	-107
> 100 to 110 GHz	109	109	122	122	-112	-112
> 110 to 120 GHz <sup>b</sup>	107	107	115	115	-110	-110
> 120 to 125 GHz <sup>b</sup>	104	104	112	112	-107	-107

a. Excludes localized spurious responses and crosstalk.

b. 110 to 125 GHz frequency range is available as operational.

c. Table represents dynamic range with Ports 1 and/or 3 driving. With Port 2 driving, dynamic range may be up to 4 dB lower in the 24-54 GHz band. With Port 4 driving, dynamic range may be up to 3 dB higher in the 24-54 GHz band.

**Test Port Power**

Port power control is provided by the base VNA for frequencies below 54 GHz, and by the 3743A mm-Wave module for frequencies greater than 54 GHz. Port Power and Power Range tables represent powers available at Ports 1 and 3. Max Power may be up to 4 dB lower on Port 2 in the 24 GHz to 54 GHz band (only for Option 31 systems). Max Power may be up to 3 dB higher on Port 4 in the 24 GHz to 54 GHz band. All values typical.

Frequency Range	Port Power <sup>a</sup>		Port Power <sup>a</sup> W/MS4647B Opt 31 Dual Source Architecture	
	Max Power ME7838A4 Option 51	Max Power ME7838A4 Option 62	Max Power ME7838A4 Option 31/51	Max Power ME7838A4 Option 31/62
	70 kHz to 300 kHz	4	6	6
> 0.3 to 2 MHz	4	6	6	8
> 2 to 10 MHz	6	6	8	8
> 0.01 to 2.5 GHz	8	6	12	10
> 2.5 to 24 GHz	-6	-8	-5	-7
> 24 to 54 GHz	-14	-16	-13	-15
> 54 to 60 GHz	0	0	0	0
> 60 to 65 GHz	1	1	1	1
> 65 to 80 GHz	-2	-2	-2	-2
> 80 to 85 GHz	-3	-3	-3	-3
> 85 to 90 GHz	-3	-3	-3	-3
> 90 to 95 GHz	1	1	1	1
> 95 to 100 GHz	1	1	1	1
> 100 to 110 GHz	-3	-3	-3	-3
> 110 to 120 GHz <sup>b</sup>	-3	-3	-3	-3
> 120 to 125 GHz <sup>b</sup>	-3	-3	-3	-3

- a. Using the 806-206-R 1.85 mm (61 cm, 24 in long) test port cables between the VNA and the 3743A mm-Wave modules.
- b. 110 GHz to 125 GHz frequency range is available as operational.

**Power Range, Accuracy, Linearity, and Resolution**

Accuracy is defined at -10 dBm or max rated power, whichever is lower. Linearity is defined as the incremental error between the accuracy test power level and 5 dB below. A user power calibration is advised for optimum power accuracy. Typical.

Frequency	Range (dB)		Accuracy (dB) <sup>a</sup>	Linearity (dB)	Resolution (dB)
	ME7838A4 Option 51	ME7838A4 Option 62			
70 kHz to 300 kHz	4 to -25	6 to -85	±1.5	±1.5	0.01
> 0.3 to 2 MHz	4 to -25	6 to -85	±1.5	±1.5	0.01
> 2 to 10 MHz	6 to -25	6 to -85	±1.5	±1.5	0.01
> 0.01 to 2.5 GHz	8 to -25	6 to -85	±1.0	±1.0	0.01
> 2.5 to 24 GHz	-6 to -25	-8 to -85	±1.0	±1.0	0.01
> 24 to 54 GHz	-14 to -30	-16 to -90	±1.5	±1.0	0.01
> 54 to 60 GHz	0 to -55	0 to -55	±2.0	±1.5	0.01
> 60 to 65 GHz	1 to -55	1 to -55	±2.0	±1.5	0.01
> 65 to 80 GHz	-2 to -55	-2 to -55	±2.0	±1.5	0.01
> 80 to 85 GHz	-3 to -55	-3 to -55	±2.0	±1.5	0.01
> 85 to 90 GHz	-3 to -55	-3 to -55	±2.0	±1.5	0.01
> 90 to 95 GHz	1 to -55	1 to -55	±2.0	±1.5	0.01
> 95 to 100 GHz	1 to -55	1 to -55	±3.0	±2.0	0.01
> 100 to 110 GHz	-3 to -55	-3 to -55	±3.0	±2.0	0.01
> 110 to 120 GHz <sup>b</sup>	-3 to -40	-3 to -40	±4.0	±3.0	0.01
> 120 to 125 GHz <sup>a</sup>	-3 to -40	-3 to -40	±4.0	±3.0	0.01

- a. Accuracy does not include effects of the MN4697C test set (affects < 54 GHz).
- b. 110 to 125 GHz frequency range is available as operational.

**Receiver Compression<sup>a</sup>**

Receiver compression point is defined as the port power level beyond which the response may be compressed more than 0.2 dB relative to normalization level. 10 Hz IF bandwidth used to remove trace noise effects. All typical.

Frequency Range	Compression ME7838A4 Option 51	Compression ME7838A4 Option 62
70 kHz to 300 kHz	6	6
> 0.3 to 10 MHz	12	13
> 0.01 to 24 GHz	12	14
> 24 to 110 GHz <sup>b</sup>	10	10
> 110 to 125 GHz <sup>b</sup>	5	5

- a. Using the 806-206-R 1.85 mm (61 cm, 24 in long) test port cables between the VNA and the 3743A mm-Wave modules.
- b. 110 GHz to 125 GHz frequency range is available as operational.

**High Level Noise**

Noise measured at 1 kHz IF bandwidth, at maximum power or compression limit (whichever is less), with through transmission. RMS. Typical.

Frequency (GHz)	Magnitude (dB)	Phase (deg)
70 kHz to 500 kHz	< 0.04	< 0.4
> 0.5 to 2 MHz	< 0.006	< 0.06
> 2 to 10 MHz	< 0.006	< 0.06
> 0.01 to 24	< 0.006	< 0.06
> 24 to 54	< 0.005	< 0.06
> 54 to 80	< 0.005	< 0.06
> 80 to 110	< 0.008	< 0.09
> 110 to 120 <sup>a</sup>	< 0.010	< 0.20
> 120 to 125 <sup>a</sup>	< 0.025	< 0.30

a. 110 to 125 GHz frequency range is available as operational.

**Stability**

Ratioed measurement at maximum leveled power with nominally a full coaxial reflect or a stable coaxial thru over the normal specified temperature range. Typical.

Frequency (GHz)	Magnitude (dB/°C)	Phase (deg/°C)
70 kHz to 300 kHz	< 0.015	< 0.15
> 0.3 to 2 MHz	< 0.015	< 0.1
> 2 to 10 MHz	< 0.02	< 0.1
> 0.01 to 2.5	< 0.02	< 0.05
> 2.5 to 30	< 0.02	< 0.09
> 30 to 54	< 0.01	< 0.07
> 54 to 80	< 0.015	< 0.1
> 80 to 110	< 0.015	< 0.15
> 110 to 120 <sup>a</sup>	< 0.02	< 0.2
> 120 to 125 <sup>a</sup>	< 0.04	< 0.25

a. 110 to 125 GHz frequency range is available as operational.

**Frequency Resolution, Accuracy, and Stability**

Resolution	Accuracy	Stability
1 Hz	$\pm 5 \times 10^{-7}$ Hz/Hz (at time of calibration)	$< 5 \times 10^{-9}/^{\circ}\text{C}$ over 0 °C to 50 °C temperature < $1 \times 10^{-9}$ /day aging, instrument on

**Uncorrected (Raw) Port Characteristics**

Typical performance

Frequency (GHz)	Directivity (dB)	Port Match (dB)
70 kHz to 0.01 MHz	10 <sup>a</sup>	8
> 0.01 to 2.5	9 <sup>a</sup>	10
> 2.5 to 30	5 <sup>a</sup>	12
> 30 to 40	5 <sup>a</sup>	5
> 40 to 54	10	5
> 54 to 80	10	10
> 80 to 110	5	7
> 110 to 120 <sup>b</sup>	5	7
> 120 to 125 <sup>b</sup>	5	7

a. Raw directivity is degraded below 300 kHz, 2.2 to 2.5 GHz and in narrow bands within 10 to 34 GHz.

b. 110 to 125 GHz frequency range is available as operational.

**Corrected System Performance and Uncertainties – SOLT/SSST**

With 12-term concatenated SOLT and Triple Offset Short Calibration (SSST), using the 3656B W1 Calibration Kit. Typical.

Frequency (GHz)	Directivity (dB)	Source Match (dB)	Load Match (dB)	Reflection Tracking (dB)	Transmission Tracking (dB)
70 kHz to 10 MHz	36	36	36	± 0.1	± 0.1
> 0.01 to 2.5	40	41	40	± 0.05	± 0.03
> 2.5 to 20	40	41	40	± 0.05	± 0.05
> 20 to 67	38	41	38	± 0.05	± 0.07
> 67 to 95	37	42	37	± 0.05	± 0.07
> 95 to 110	35	35	35	± 0.05	± 0.07

**Measurement Uncertainties – SOLT/SSST**

The graphs give measurement uncertainties after the above calibration. The errors are worst case contribution of residual directivity, load and source match, frequency response and isolation, network analyzer dynamic accuracy, and connector repeatability while noise effects are added on an RSS basis. 10 Hz IF Bandwidth is used. For transmission uncertainties, it is assumed that  $S_{11} = S_{22} = 0$ . For reflection uncertainties, it is assumed that  $S_{21} = S_{12} = 0$ . For other conditions, please use our free Exact Uncertainty calculator software, downloadable from the Anritsu web site at, [www.anritsu.com](http://www.anritsu.com).

**Note** Although the graph axes show specific S-parameters, they apply to all transmission or reflection parameters, as appropriate.

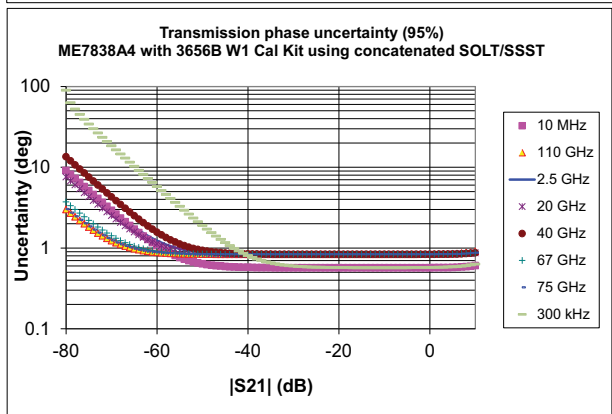
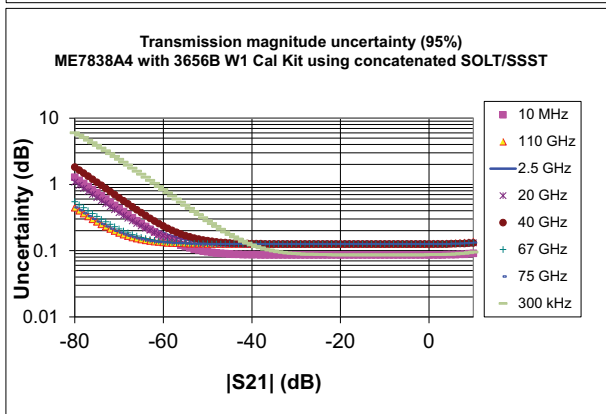
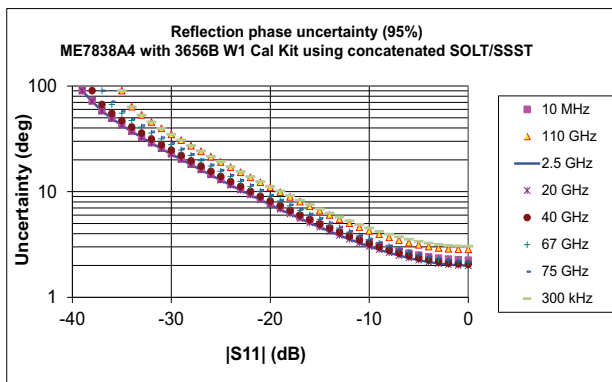
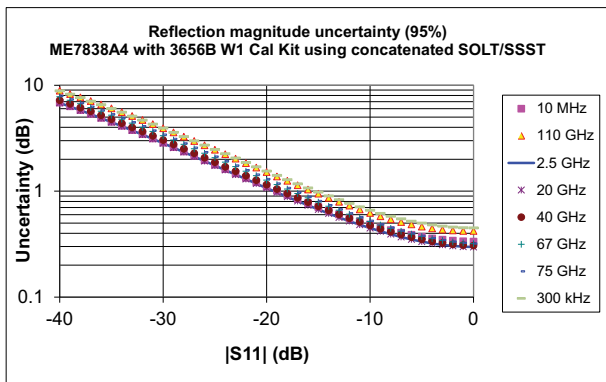

**Corrected System Performance and Uncertainties – SOLT/SSST with .s1p Standards Definitions**

With 12-term concatenated SOLT and Triple Offset Short Calibration (SSST), using the 3656B-3 W1 Calibration Kit. Typical values are in parentheses. Load match is limited by residual directivity. Cable flexure and drift effects are not included.

Frequency (GHz)	Directivity (dB)	Source Match (dB)	Load Match (dB)	Reflection Tracking (dB)	Transmission Tracking (dB)
70 kHz to 10 MHz	43 (50)	43 (50)	40 (43)	± 0.1	± 0.1
> 0.01 to 2.5	43 (50)	43 (50)	40 (43)	± 0.05	± 0.03
> 2.5 to 20	43 (50)	43 (50)	40 (43)	± 0.05	± 0.05
> 20 to 67	42 (47)	42 (47)	39 (42)	± 0.05	± 0.07
> 67 to 95	40 (43)	41 (45)	37 (40)	± 0.05	± 0.07
> 95 to 110	38 (41)	40 (43)	35 (38)	± 0.05	± 0.07

**Measurement Uncertainties – SOLT/SSST with .s1p Standards Definitions**

The graphs give measurement uncertainties after the above calibration. The errors are worst case contribution of residual directivity, load and source match, frequency response and isolation, network analyzer dynamic accuracy, and connector repeatability while noise effects are added on an RSS basis. 10 Hz IF Bandwidth is used. For transmission uncertainties, it is assumed that  $S_{11} = S_{22} = 0$ . For reflection uncertainties, it is assumed that  $S_{21} = S_{12} = 0$ . For other conditions, please use our free Exact Uncertainty calculator software, downloadable from the Anritsu web site at, [www.anritsu.com](http://www.anritsu.com).

**Note** Although the graph axes show specific S-parameters, they apply to all transmission or reflection parameters, as appropriate.

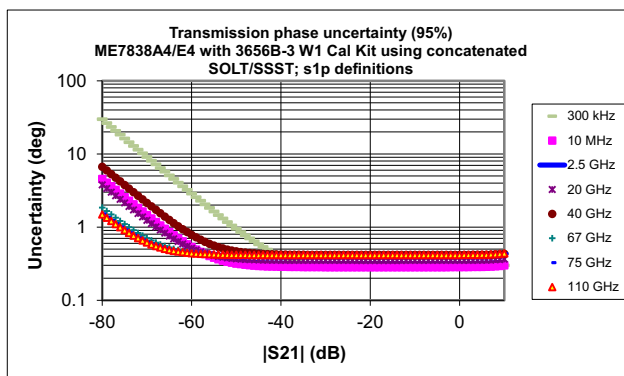
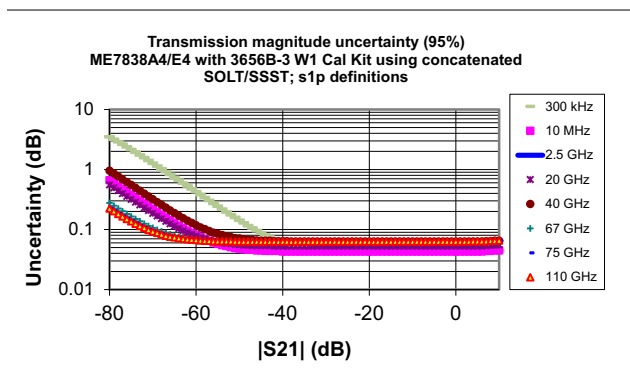
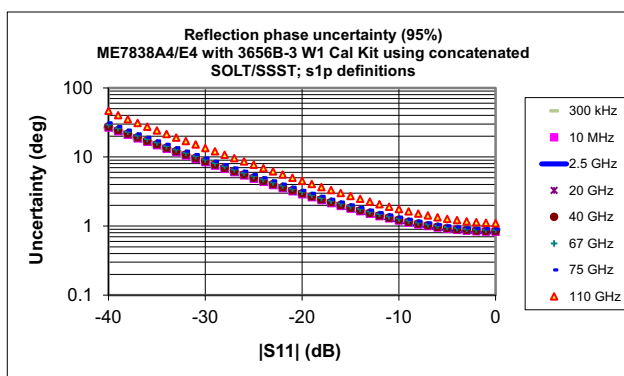
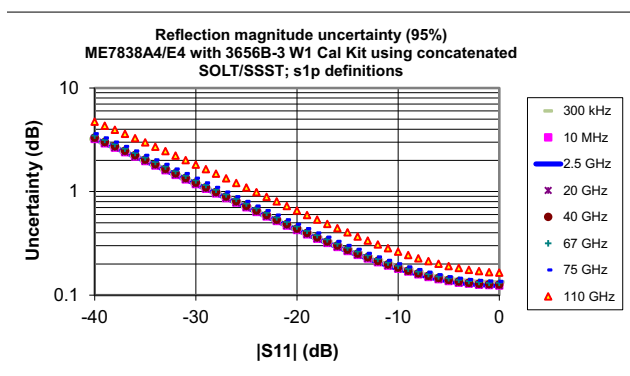



**Corrected System Performance and Uncertainties - LRL/LRM**

With 12 term LRL/LRM calibration using single-ended probes and on-wafer substrate standards. Typical. Based on a typical vendor supplied impedance standard substrate.

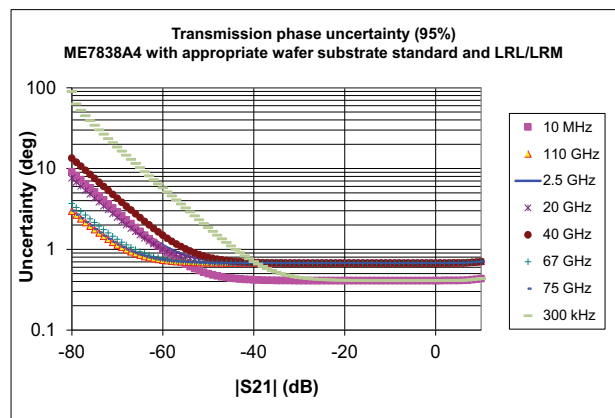
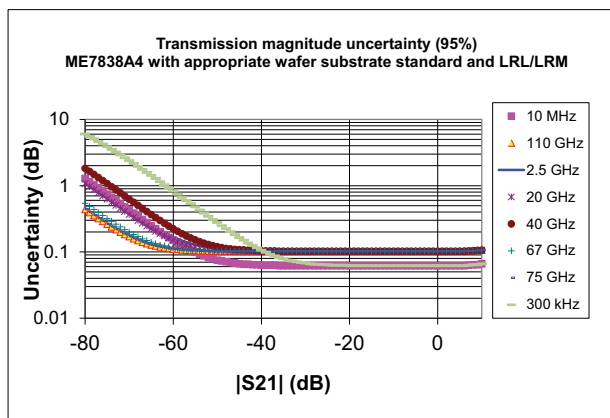
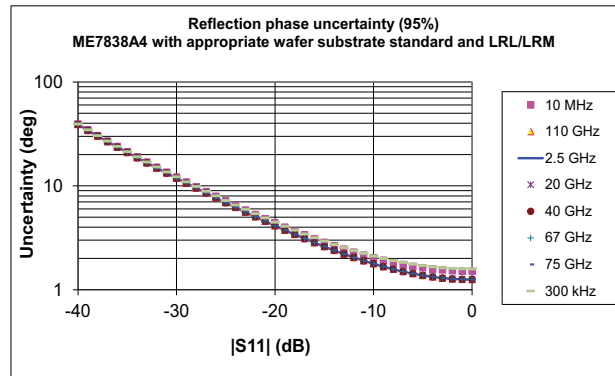
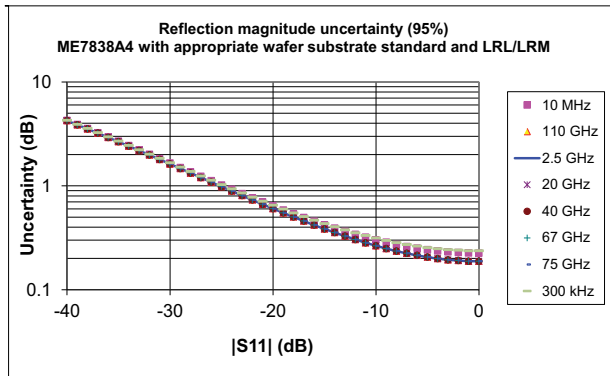

Block Diagram – ME7838A4 4-Port Broadband VNA System

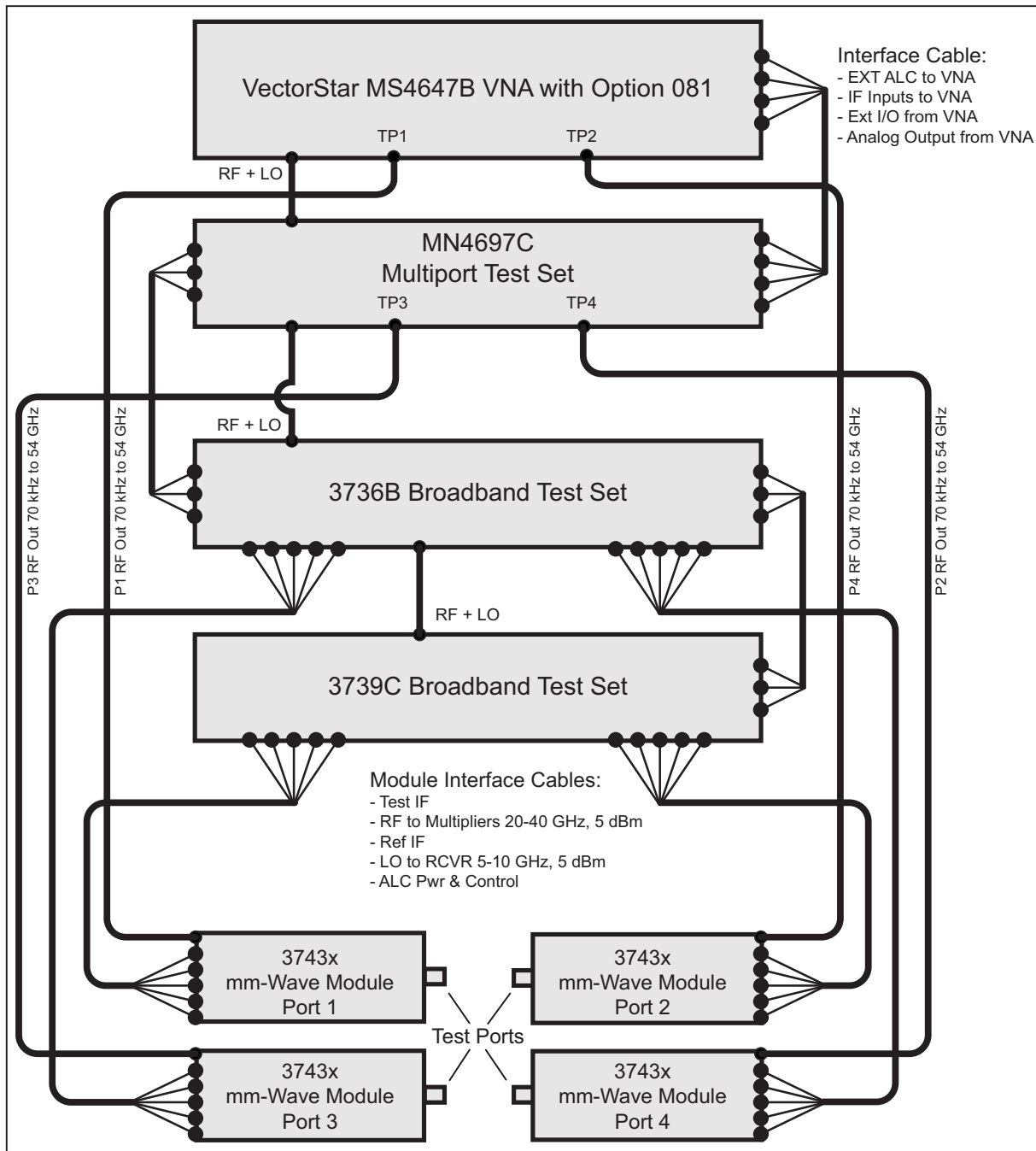

ME7838A4 4-Port Broadband (70 kHz to 110 GHz) Configuration Block Diagram

**SC8215 and SC7287 Kelvin Bias Tees**

Provides Sense and Force SMC connections close to the mm-Wave module to minimize the IR drops associated with the impedances between the bias tee and the DUT. The bias tees are V-type connectors and are to be connected to the inputs of the 374x modules.

Part Number	Description	Voltage	Current
SC8215	The SC8215 is a V-connectorized bias tee usable with the mm-wave modules in the ME7838A4 for system frequencies of 70 kHz to 125 GHz. Stand-alone, it is usable to 70 GHz.	Max Voltage: 16 VDC	Max Current: 100 mA
SC7287	The SC7287 is a V-connectorized bias tee usable with the mm-wave modules in the ME7838A4 for system frequencies of 100 MHz to 125 GHz. Stand-alone, it is usable to 70 GHz.	Max Voltage: 50 VDC	Max Current: 500 mA
Tri-Axial Output SMUs	For applications requiring Source Measure Units (SMU) with tri-axial outputs, a tri-axial (male) to SMC (male) cable is available. Check the accessories list for ordering information <a href="#">on page 32</a> .		

**Measurement Examples**

The following figures are measurement examples of typical ME7838A4 Broadband system performance.

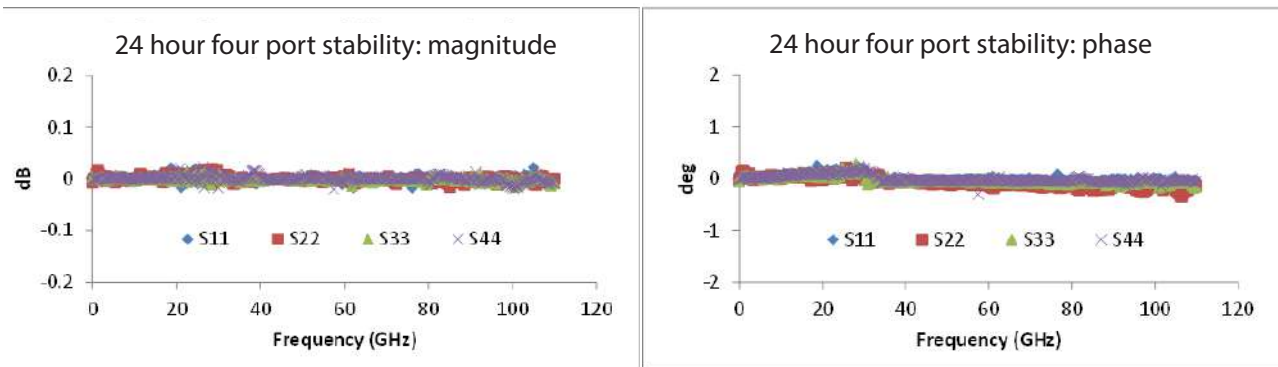

ME7838A4 4-port typical Broadband Reflection Magnitude and Phase Stability with temperature held constant (25 °C).

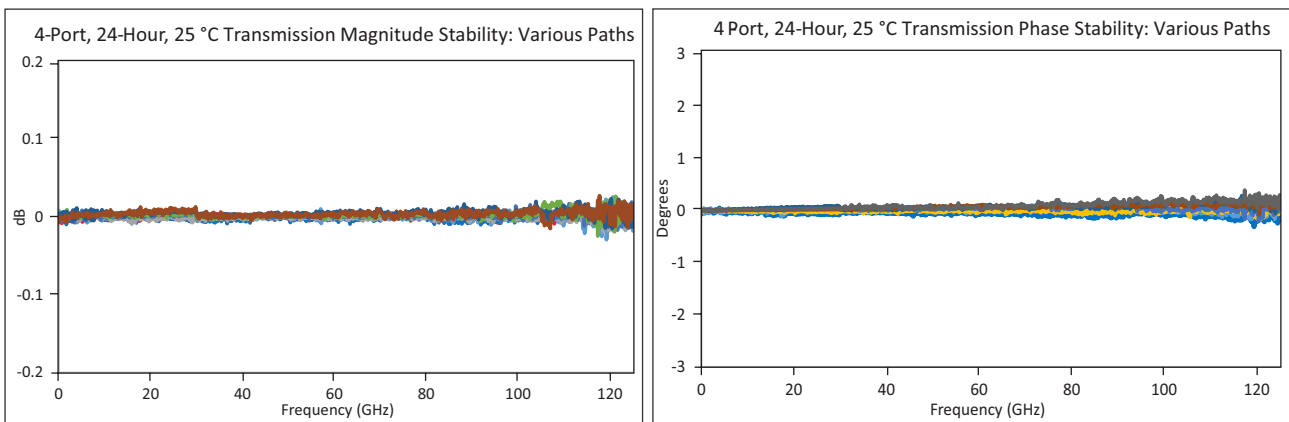

ME7838A4 4-port typical broadband transmission stability over 24 hours with temperature held constant (25 °C). Measurements of thru lines on a sampling of the possible two-port paths are represented.

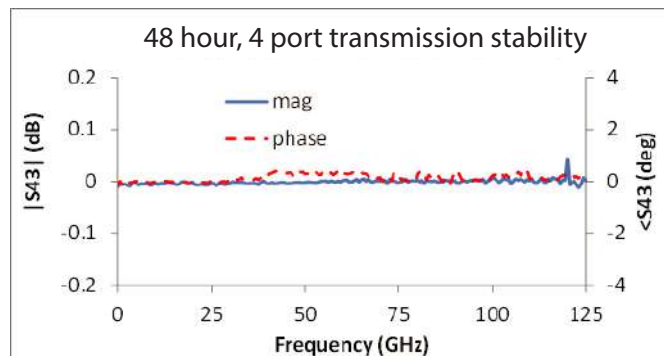

ME7838A4 4-Port Typical Transmission Stability over 48 hours and 6 °C Temperature swing.

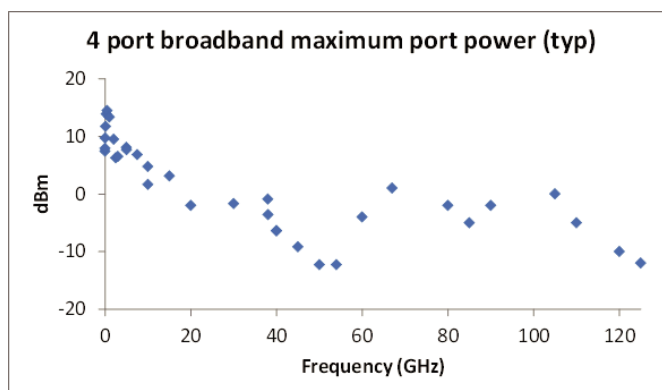

ME7838A4 4-Port Broadband Typical Maximum Port Power. Units with Option 31 will typically have higher maximum power below 54 GHz.

**Specifications for Waveguide Band Configuration**

**ME7838A4 4-Port Millimeter-Wave VNA, Waveguide Bands**

Three configurations are available for 4-port waveguide band operation for E and W bands when using the ME7838A4 4-port system.

- First, the Anritsu 3743A Broadband Millimeter-Wave (mm-Wave) module can be configured for waveguide measurements using waveguide adapters.
- Second, the Anritsu 3744A-EE or 3744A-EW millimeter-Wave module can be used. These version modules operate in the extended E and W waveguide bands and are operational using the MS4644B or MS4647B VectorStar (with options 8x and 7), and the 3739C broadband/millimeter-wave test set and 3736B Broadband test set.
- The third configuration option is to use external millimeter-wave modules with any model VectorStar (with Options 8x and 7), and the 3739C test set and 3736B broadband/millimeter-wave test set. For millimeter bands above 110 GHz, either the OML or VDI modules may be used.

**E and W Band Operation Using the 3743A, 3744A-EE, or 3744A-EW mm-Wave Module**



3743A Millimeter-Wave Modules



3744A-EE/3744A-EW Millimeter-Wave Module with Waveguide Adapter

The 3743A Broadband mm-Wave module can be adapted to a waveguide band output by adding an available waveguide band adapter and mounting flange. VectorStar menus automatically configure the system frequencies incorporating the 3743A module for banded operation. Using the 3743A modules provides the opportunity to sweep frequencies for broadband applications and quickly convert to waveguide configurations for banded measurements. The advantages of small compact modules with excellent RF performance and power range control can therefore be realized in both broadband and waveguide configurations when using the 3743A mm-Wave module. For systems where only waveguide band operation is required, the 3744A-EE or 3744A-EW mm-Wave module can be used.

The 3744A-EE or 3744A-EW mm-Wave module operates from 54 GHz to 110 GHz. The band supported is determined by the waveguide adapter connected to the 1 mm test port output of the 3744A-EE/EW module:

- 3744A-EE configures the module for Extended E Band
- 3744A-EW configures for Extended W Band

The RF input port of the 3744A-EE or 3744A-EW module is restricted below 54 GHz, however, the RF input port retains a DC connection to the 1 mm test port. Thus, the waveguide adapter can be removed for on-wafer applications from 54 GHz to 110 GHz operation and the on-wafer DUT can be biased through the RF input port.

Band	Frequency Range	Waveguide Flange	Transmission/Reflection Module
Ext-E	56 to 94 GHz <sup>a</sup>	WR-12	3744A-EE
Ext-W	65 to 110 GHz	WR-10	3744A-EW

a. Operational to 95 GHz.

### Port Power, Noise Floor, Dynamic Range – 3744A-EE/3744A-EW mm-Wave Modules

System dynamic range is defined as the ratio of the source power to the noise floor.

Maximum Receiver Power is defined as the 0.2 dB compression point of the receiver at the waveguide port.

Receiver dynamic range is defined as the ratio of maximum receive power to the noise floor.

Noise Floor measurements are RMS, are made with no average in a 10 Hz IF bandwidth, and include an isolation calibration.

All values are typical.

### 3744A-EE Extended-E Band (WR-12) Waveguide

Frequency Range (GHz)	Source Power (dBm)	Max. Receive Power (0.2 dB comp. pt.) (dBm)	Noise Floor (dBm)	System Dynamic Range (dB)	Receiver Dynamic Range (dB)
56 to 60	-2	11	-111	109	122
> 60 to 65	0	11	-106	106	117
> 65 to 80	-3	11	-109	106	120
> 80 to 85	-4	11	-112	108	123
> 85 to 90	-4	11	-110	106	121
> 90 to 94 <sup>a</sup>	0	12	-105	105	117

a. Operational to 95 GHz.

### 3744A-EW Extended-W Band (WR-10) Waveguide

Frequency Range (GHz)	Source Power (dBm)	Max. Receive Power (0.2 dB comp. pt.) (dBm)	Noise Floor (dBm)	System Dynamic Range (dB)	Receiver Dynamic Range (dB)
65 to 67	0	11	-106	106	117
> 67 to 80	-3	11	-109	106	120
> 80 to 85	-4	11	-112	108	123
> 85 to 90	-4	11	-110	106	121
> 90 to 100	0	12	-105	105	117
> 100 to 110	-5	12	-110	105	122

### Power Range, Accuracy, Linearity, and Resolution

Accuracy is defined at -10 dBm or max rated power, whichever is lower. Linearity is defined as the incremental error between the accuracy test power level and 5 dB below. Typical.

Frequency (GHz)	Range (dBm)		Accuracy (dB)	Linearity (dB)	Resolution (dB)
	ME7838A4	ME7838A4 Option 62			
54 to 60	-55 to -2	-55 to -2	± 2.0	± 1.5	0.01
> 60 to 65	-55 to 0	-55 to 0	± 2.0	± 1.5	0.01
> 65 to 80	-55 to -3	-55 to -3	± 2.0	± 1.5	0.01
> 80 to 85	-55 to -4	-55 to -4	± 2.0	± 1.5	0.01
> 85 to 90	-55 to -4	-55 to -4	± 2.0	± 1.5	0.01
> 90 to 100	-55 to 0	-55 to 0	± 3.0	± 2.0	0.01
> 100 to 110	-55 to -5	-55 to -5	± 3.0	± 2.0	0.01
> 110 to 120 <sup>a</sup>	-40 to -3	-40 to -3	± 4.0	± 3.0	0.01
> 120 to 125 <sup>a</sup>	-40 to -3	-40 to -3	± 4.0	± 3.0	0.01

a. 110 to 125 GHz frequency range is available as operational.

Alternatively, the V, E, and W bands can be supported using external millimeter-wave modules such as the 3740/41A series modules available from Anritsu. For further description and specifications please refer to the VectorStar ME7838A Technical Data Sheet – 11410-00593 available at [www.anritsu.com](http://www.anritsu.com).

**Corrected System Performance/Uncertainties - 3744A-EE/3744A-EW mm-Wave Modules**

With 12-term Offset Short Sliding Load or LRL calibrations, using high precision waveguide sections and standards from the appropriate calibration kit.

**3744A-EE Extended-E Band (WR-12) Waveguide - 56 GHz to 94 GHz**

Calibration Type	Directivity (dB)	Source Match (dB)	Load Match (dB)	Reflection Tracking (dB)	Transmission Tracking (dB)
Offset Short	> 44	> 33	> 44	± 0.080	± 0.100
LRL	> 44	> 43	> 44	± 0.006	± 0.006

**3744A-EW Extended-W Band (WR-10) Waveguide - 65 GHz to 110 GHz**

Calibration Type	Directivity (dB)	Source Match (dB)	Load Match (dB)	Reflection Tracking (dB)	Transmission Tracking (dB)
Offset Short	> 40	> 30	> 46	± 0.080	± 0.100
LRL	> 40	> 40	> 46	± 0.006	± 0.006

**Measurement Uncertainties - Extended-E Band - SSLT**

The graphs give measurement uncertainties after the above calibration. The errors are worst case contribution of residual directivity, load and source match, frequency response and isolation, network analyzer dynamic accuracy, and connector repeatability. 10 Hz IF Bandwidth is used. For transmission uncertainties, it is assumed that  $S_{11}=S_{22}=0$ . For reflection uncertainties, it is assumed that  $S_{21}=S_{12}=0$ . All calibrations and measurements were performed at default port power. For other conditions, please use our free Exact Uncertainty Calculator software, available for download from the Anritsu web site at [www.anritsu.com](http://www.anritsu.com). Typical.

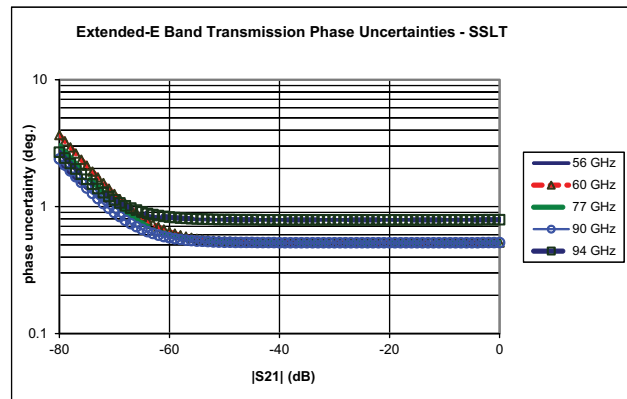
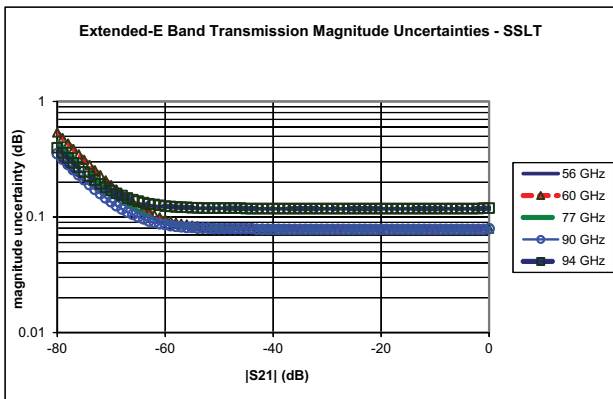
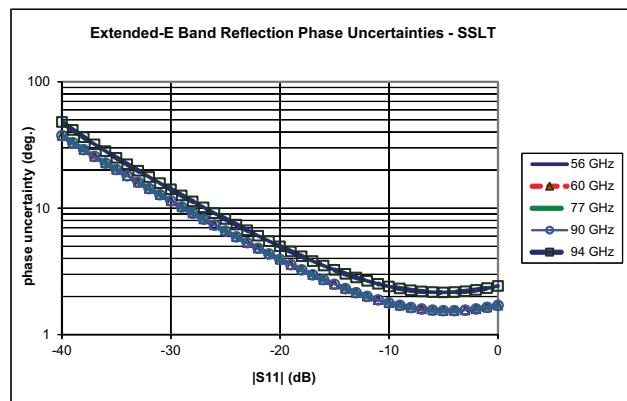
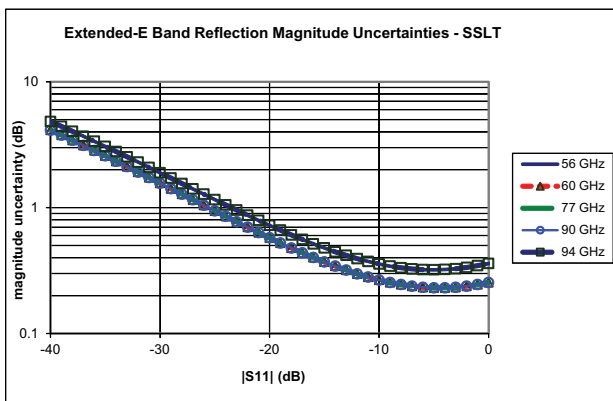

**Measurement Uncertainties – Extended-E Band – LRL**

The graphs give measurement uncertainties after the above calibration. The errors are worst case contribution of residual directivity, load and source match, frequency response and isolation, network analyzer dynamic accuracy, and connector repeatability. 10 Hz IF Bandwidth is used. For transmission uncertainties, it is assumed that  $S_{11}=S_{22}=0$ . For reflection uncertainties, it is assumed that  $S_{21}=S_{12}=0$ . All calibrations and measurements were performed at default port power. For other conditions, please use our free Exact Uncertainty Calculator software, available for download from the Anritsu web site at [www.anritsu.com](http://www.anritsu.com). Typical.

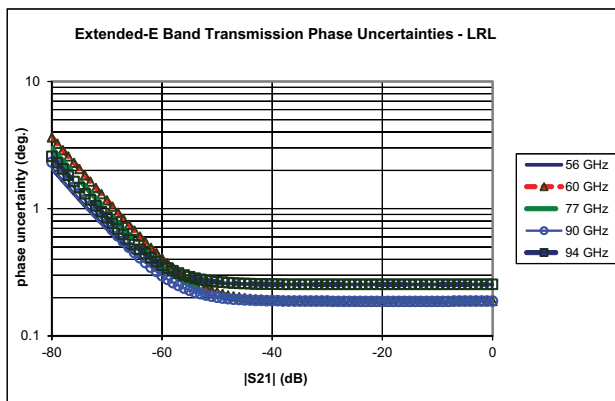
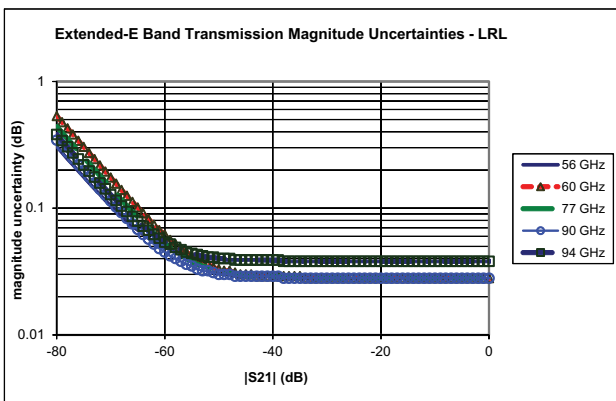
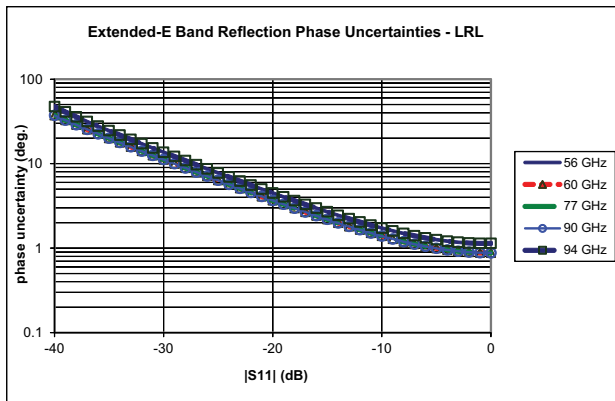
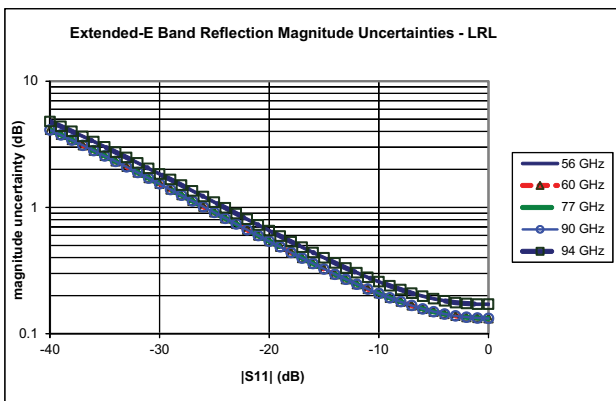



**Measurement Uncertainties – Extended-W Band – SSLT**

The graphs give measurement uncertainties after the above calibration. The errors are worst case contribution of residual directivity, load and source match, frequency response and isolation, network analyzer dynamic accuracy, and connector repeatability. 10 Hz IF Bandwidth is used. For transmission uncertainties, it is assumed that  $S_{11}=S_{22}=0$ . For reflection uncertainties, it is assumed that  $S_{21}=S_{12}=0$ . All calibrations and measurements were performed at default port power. For other conditions, please use our free Exact Uncertainty Calculator software, available for download from the Anritsu website at [www.anritsu.com](http://www.anritsu.com). Typical.

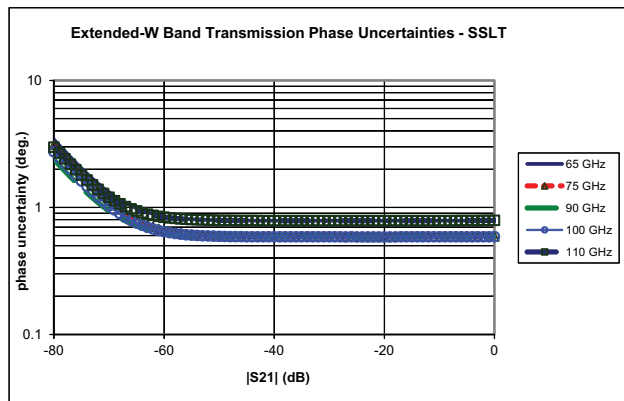
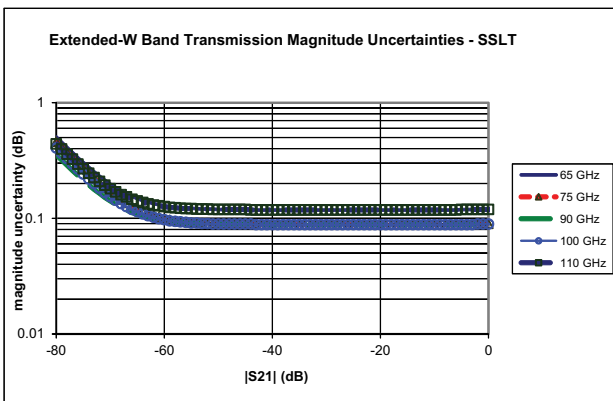
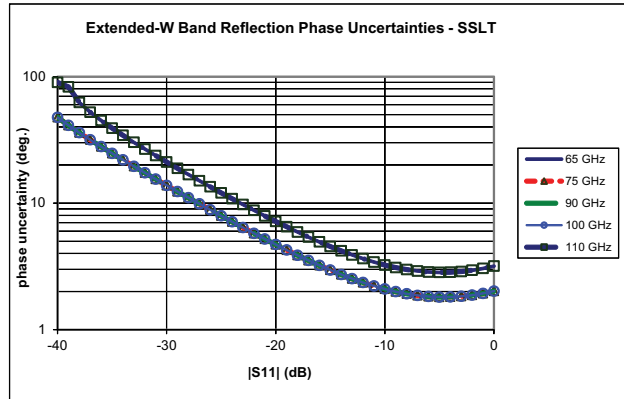
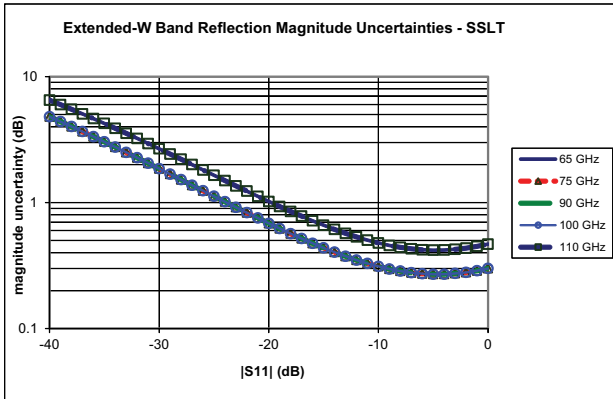

**Measurement Uncertainties – Extended-W Band – LRL**

The graphs give measurement uncertainties after the above calibration. The errors are worst case contribution of residual directivity, load and source match, frequency response and isolation, network analyzer dynamic accuracy, and connector repeatability. 10 Hz IF Bandwidth is used. For transmission uncertainties, it is assumed that  $S_{11} = S_{22} = 0$ . For reflection uncertainties, it is assumed that  $S_{21} = S_{12} = 0$ . All calibrations and measurements were performed at default port power. For other conditions, please use our free Exact Uncertainty Calculator software, available for download from the Anritsu website at [www.anritsu.com](http://www.anritsu.com). Typical.

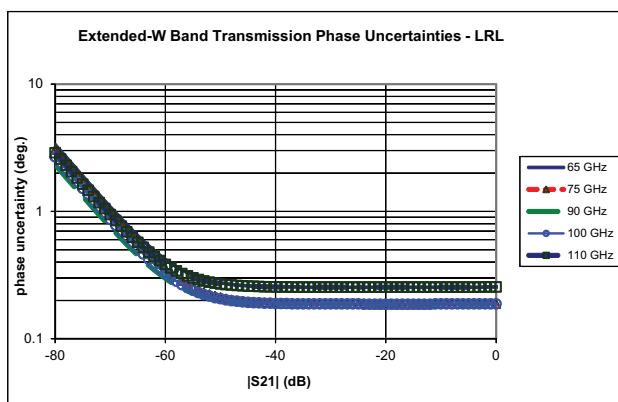
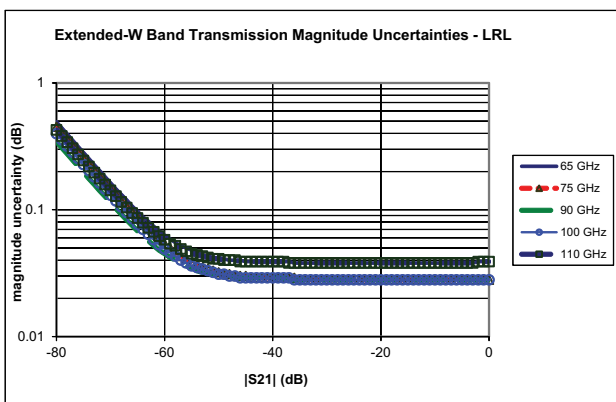
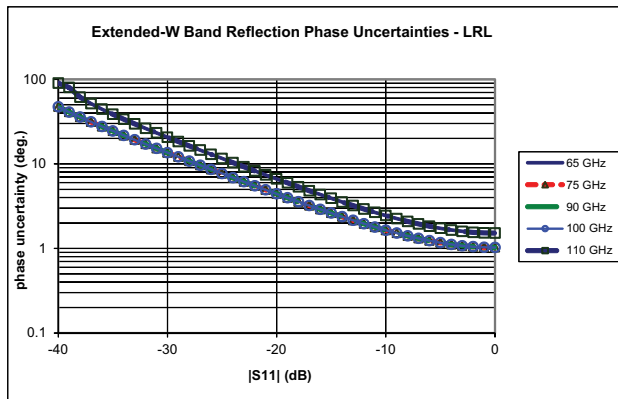
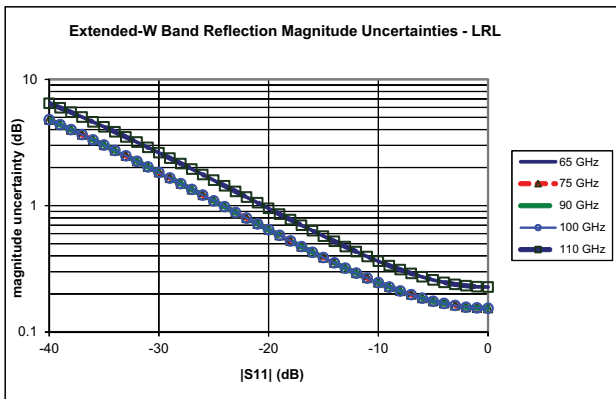

## ME7838A4 with Option 41/48 and 3744A-Rx mm-Wave Noise Figure Measurements

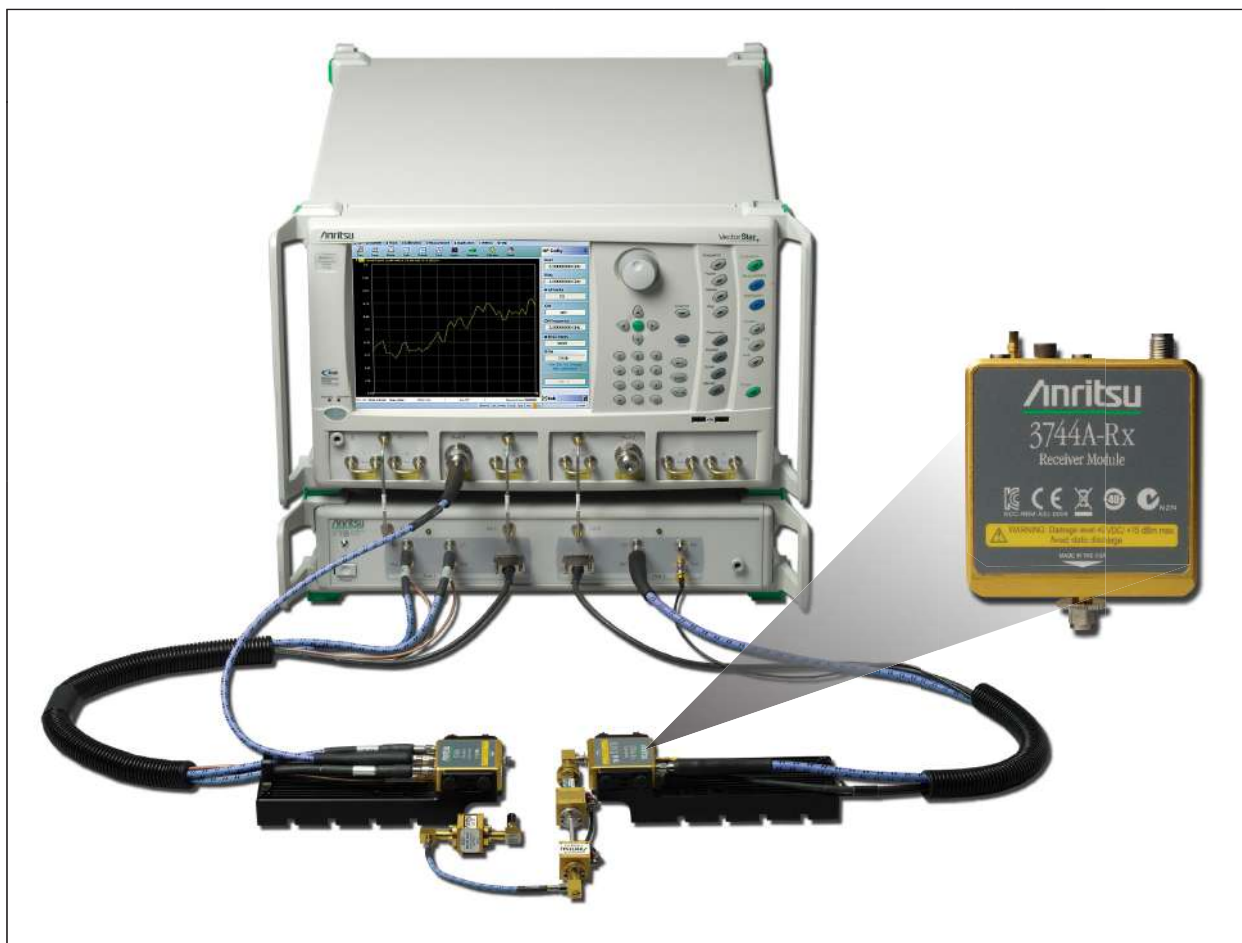

3744A-Rx Receiver Module

The 3744A-Rx receiver module can be used with Option 41, Noise Figure, and the ME7838A4 mm-Wave or broadband system to perform mm-Wave noise figure measurements from 30 GHz to 125 GHz. The receiver bypasses the internal couplers (see block diagram), maximizing the noise figure of the receiver for optimum noise figure measurement accuracy. The receiver is derived from the 3743A mm-Wave module and utilizes the same nonlinear transmission line technology for optimum mm-Wave performance. Using the advantages of the 3743A mm-Wave module system architecture provides a unique solution to mm-Wave noise figure measurements previously unavailable.

With Option 48, differential (and common-mode) noise figure measurements are possible in the same wide frequency ranges. In this case, two 3744A-Rx modules (along with needed pre-amplifiers/filters) are used to complete the differential receiver. The Rx modules are typically connected as ports 2 and 4 to act as the differential/common-mode noise receiver when used with the ME7838A4.

**Block Diagram – 3744A Receiver Module**

As with all cold source method noise figure measurements, the output of the DUT is first sent to an external composite receiver for pre-amplification. This ensures that the system noise figure is minimized for optimum measurement accuracy. The Anritsu Noise Figure Uncertainty Calculator (available on the website at [www.anritsu.com](http://www.anritsu.com)) can be used to determine optimum preamplifier gain needed for the desired measurement uncertainty.

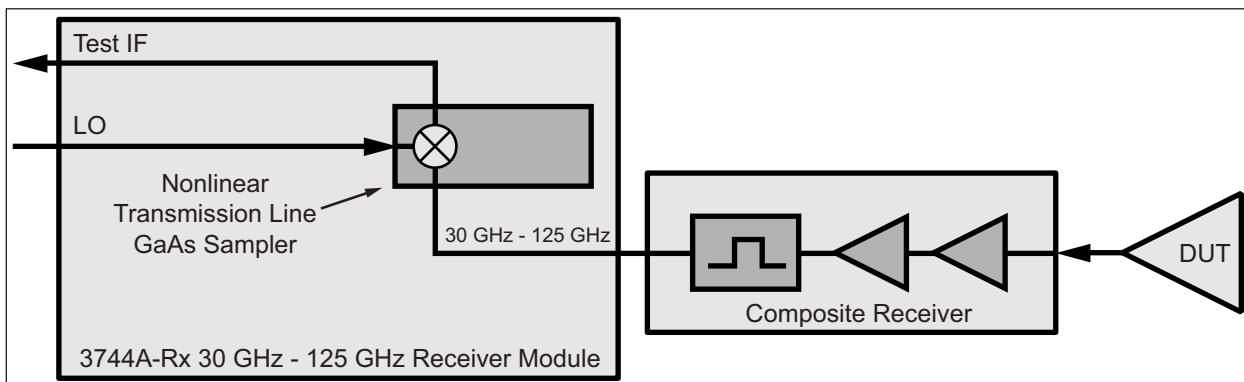

3744A-Rx Block Diagram

(Two composite receivers and two 3744A-Rx modules are used with Option 48 for differential or common-mode noise figure measurements.)

**3744A-Rx Receiver Compression, Noise Floor**

Receiver Compression Point is defined as the port power level beyond which the response may be compressed more than 0.2 dB relative to the normalization level. 10 Hz IF bandwidth is used to remove trace noise effects. All typical.

Noise Floor is relative to the receiver power calibration performed at -10 dBm. Typical.

Frequency (GHz)	Receiver Compression (dBm) <sup>a</sup>	Noise Floor (dBm) <sup>b</sup>
30 GHz to 54 GHz	0	-124
> 54 to 60 GHz	0	-122
> 60 to 67 GHz	0	-117
> 67 to 80 GHz	0	-120
> 80 to 85 GHz	0	-123
> 85 to 90 GHz	0	-121
> 90 to 95 GHz	0	-121
> 95 to 105 GHz	0	-117
> 105 to 110 GHz	0	-122
> 110 to 120 GHz	-5	-120
> 120 to 125 GHz	-5	-117

a. At the 3744A-Rx test port.

b. Excludes localized spurious responses and crosstalk.

**VectorStar ME7838A4 Waveguide Bands**

From 50 GHz to 750 GHz (1.1 THz). The VectorStar 4-Port Millimeter-Wave system supports OML or VDI modules starting at 50 GHz. System performance is based on the specific mm-Wave module installed and appropriate cal kit. Contact the vendor web site for additional information.



VDI and OML Millimeter-Wave Modules

**Block Diagram - Millimeter-Wave VNA System**

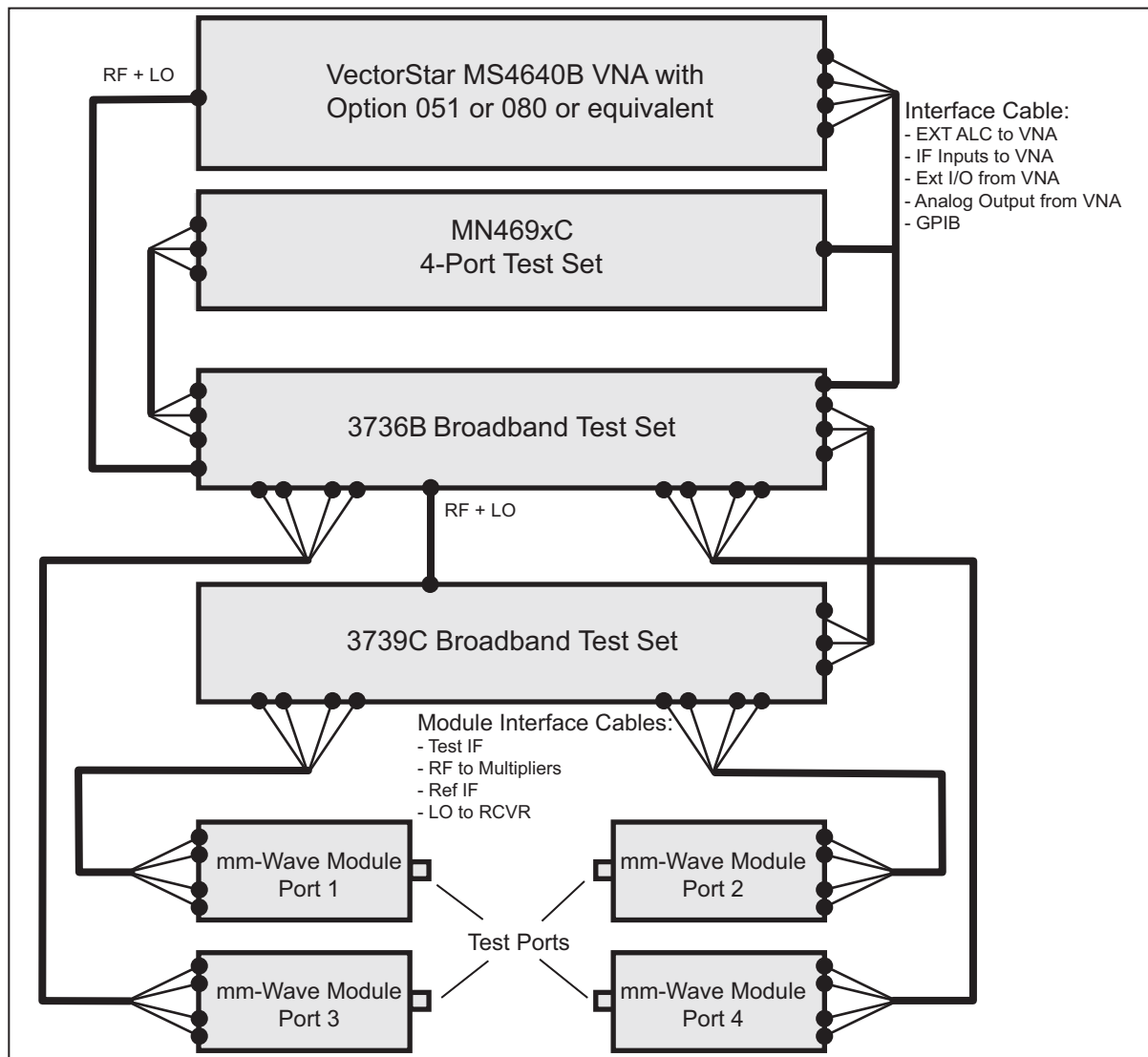

ME7838A4 4-Port Broadband Millimeter-Wave Configuration Block Diagram

**VectorStar ME7838A4 Millimeter-Wave System with VDI Modules**

This section provides the specifications for the VectorStar MS4640B series microwave Vector Network Analyzers (VNAs) when configured with the Virginia Diodes, Inc. millimeter-wave (mm-Wave) frequency extension modules. The following frequency bands are supported:

Waveguide Band	WR15	WR10	WR8.0	WR6.5	WR5.1	WR4.3	WR3.4	WR2.8	WR2.2	WR1.5	WR1.0 <sup>a</sup>
Frequency (GHz)	50 to 75	75 to 110	90 to 140	110 to 170	140 to 220	170 to 260	220 to 330	260 to 400	330 to 500	500 to 750	750 to 1100

a. Contact Anritsu

**System Configuration with VDI Modules**

The VectorStar Millimeter-Wave system provides control of VDI modules for frequency extension coverage up to 1.1 THz\*. MS4640B series VectorStar VNA may be configured for mm-Wave operation by adding the appropriate control option and test set. System requirements include:

- VectorStar VNA Model MS4642B, MS4644B, or MS4647B  
(Note: For 1.1 THz operation the 40 GHz MS4644B or higher model is required.)
- Options MS4640B Option 7, Receiver Offset  
MS4640B Option 80, 81, 82, or 83
- Test Set 3739C Test Set  
MN469xC Test Set  
3736B Test Set
- Cable SM6537 Interface Cable – Connection between VectorStar and the VDI mm-Wave module is provided with this interface cable.  
Each VDI module is equipped with a dedicated external power supply and DC cable.

**VDI Module Specifications**

- Specifications: Dynamic range (DR) specifications are valid for any MS4640B VectorStar VNA with appropriate options. Directivity specifications are valid when using appropriate VDI calibration kits. These specification results assume a through measurement with two TxRx Heads. All extender heads include a precision Test Port. The specifications here are typical and subject to change.
- Stability: Measured for 1 hour after a 1 hour system warm-up, in a stable environment with ideal cables.
- Dynamic Range: The dynamic range (RBW 10 Hz) is measured by first connecting two TxRx heads together and normalizing the un-calibrated S21 and S12. The heads are then disconnected and terminated with a waveguide short. The rms of the measured S21 & S12 give the system dynamic range.
- Test Port Power: Test Port Power is typical. Reduced power is possible at band edges.

**VDI Extenders-Summary of Specifications**

Waveguide Band	WR15	WR12	WR10	WR8.0	WR6.5	WR5.1	WR4.3	WR3.4	WR2.8	WR2.2	WR1.5	WR1.0
Frequency Coverage (GHz)	50-75	60-90	75-110	90-140	110-170	140-220	170-260	220-330	260-400	330-500	500-750	750-1100
Dynamic Range BW = 10 Hz, dB, (Typical)	120	120	120	120	120	120	115	115	100	110	100	65
Dynamic Range BW = 10 Hz, dB, minimum	110	110	110	110	110	110	110	105	80	100	80	45
Magnitude Stability (± dB)	0.15	0.15	0.15	0.15	0.25	0.25	0.3	0.3	0.5	0.5	0.4	0.5
Phase Stability (± deg.)	2	2	2	2	4	4	4	6	6	6	4	6
Test Port Power (dBm Typical)	13	13	18	6	13	6	-2	1	-10	-3	-25	-30
Test Port Input Limit <sup>a</sup> (dBm, Saturation/Damage)	30	30	30	30	30	30	28	26	16	10	-3	-3
Directivity (dB)	30	30	30	30	30	30	30	30	30	30	30	30

a. Test Port Input Limits are shown for standard test port power models only.

**VDI Module Head Configurations**

- TxRx Transmitter with two receivers (reference and measurement), and two couplers. Two TxRx heads are required for full two-port measurements.
- TxRef Transmitter with reference receiver and one coupler.
- Rx Measurement receiver.
- Tx Transmitter.

**VDI Module Options**

- Micrometer-Drive Variable Attenuator A 0 dB to 30 dB micrometer-drive variable attenuator option is available on TxRx and Tx modules up through WR1.5. If ordered, “-Attn” is added as an option suffix to the module model number. The attenuators reduce TPP and DR by as much as 5dB in the WR3.4 and higher frequency bands and add approximately 2 in to the enclosure.
- Increased Test Port Power Options exist for increasing test port power in some full bands or in partial bands. Consult factory for more information.
- Non-Standard Frequency Bands Non-standard frequency bands or other specific needs are possible. Consult factory for more information.
- Custom Configuration Anritsu/VDI will work with customers to reconfigure any extender to meet specific needs.

ME7838A4 Measurement Examples Using VDI Millimeter-Wave Modules

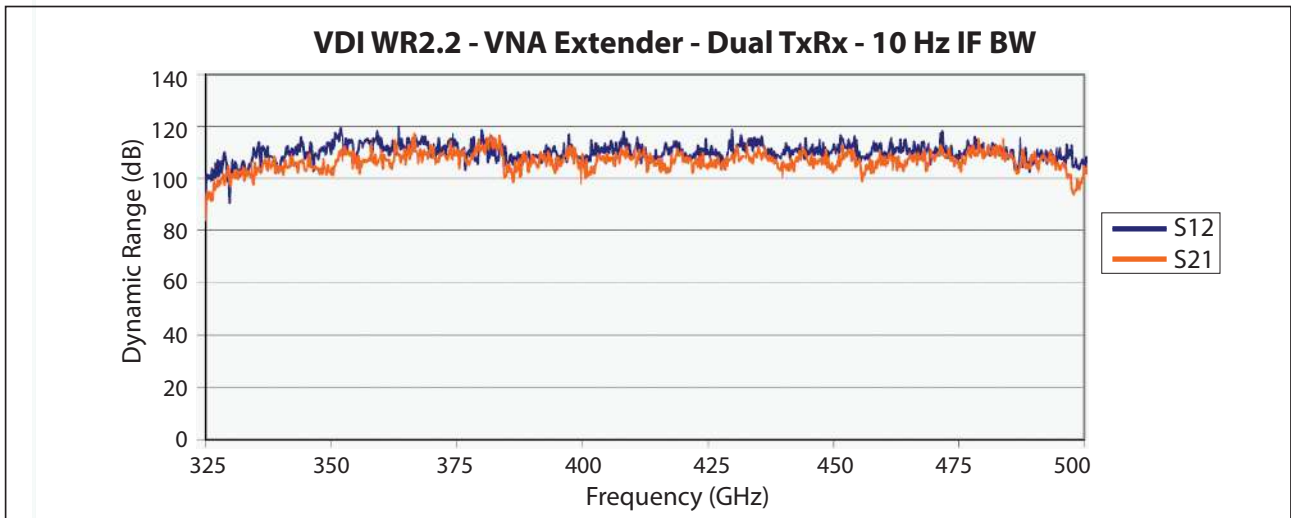

Typical Dynamic Range Plot of VDI WR2.2 Module – 10 Hz IFBW

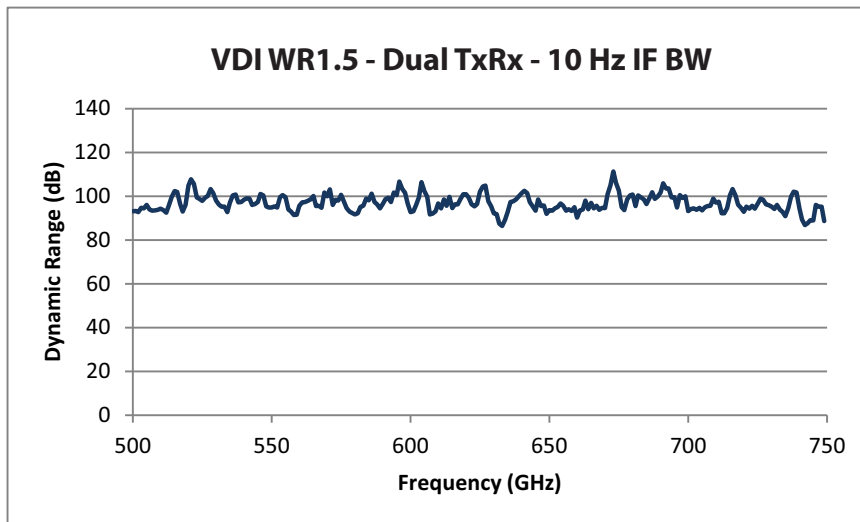

Typical Dynamic Range Plot of VDI WR1.5 Dual TxRx – 10 Hz IFBW

ME7838A4 400 GHz Power Sweep with VDI WR2.2 TxRx Module

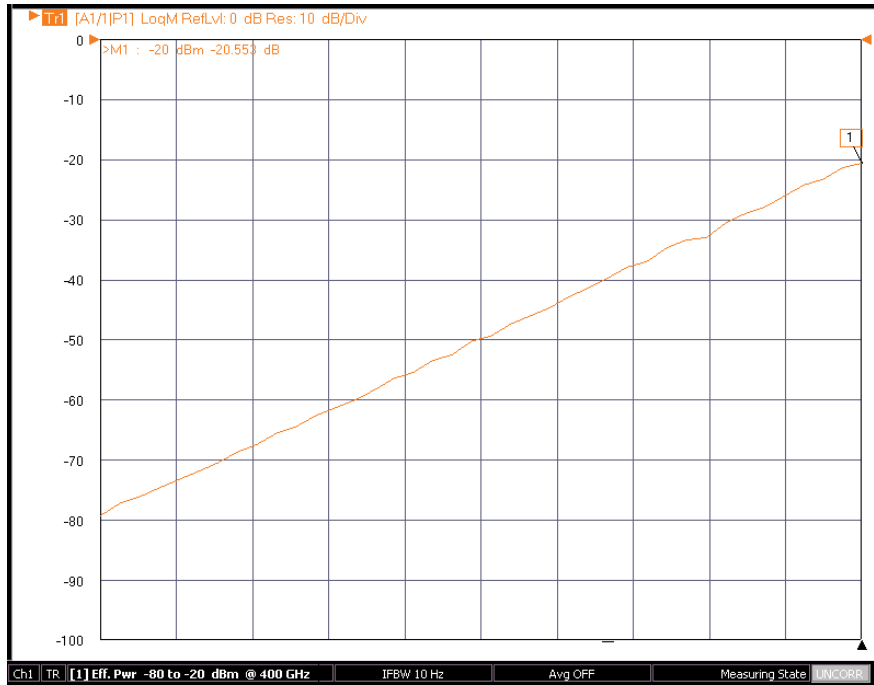

Typical real-time power sweep of VDI WR2.2 module using system power level control and no mechanical attenuators.

**VectorStar ME7838A4 Millimeter-Wave System with OML Modules**

This section provides specifications for the VectorStar MS4640B series microwave Vector Network Analyzers (VNAs) when configured with the OML millimeter-wave frequency extension modules.

Description	Each OML module must be equipped with a dedicated external power supply and DC cable. Connection between the VectorStar and the OML mm-Wave module is provided with the supplied interface cable.
System Configuration	The VectorStar Millimeter-Wave system provides control of OML modules for frequency extension coverage up to 325 GHz. The MS4640B series VectorStar VNA may be configured for mm-Wave operation by adding the appropriate control option and test set.
System requirements	MS4642B, MS4644B, or MS4647B Model VectorStar VNA MS4640B Option 7, Receiver Offset MS4640B Option 80, 81, 82, or 83 SM6537 Interface Cable 3739C Test Set MN469xC Test Set 3736B Test Set
Specifications	Dynamic range specifications are valid for any MS4640B VectorStar VNA with appropriate options. Directivity specifications are valid when using appropriate OML calibration kits.

**OML Millimeter-Wave Extenders Summary Specifications**

OML "T/R" Models <sup>a</sup>	Units	Measurement	V15VNA2-T/R	V12VNA2-T/R	V10VNA2-T/R	V08VNA2-T/R	V06VNA2-T/R	V05VNA2-T/R	V03VNA2-T/R
<b>Output Interface<sup>b</sup> Operating Frequency</b>	GHz	-	WR-15 50 – 75	WR-12 60 – 90	WR-10 75 – 110	WR-08 90 – 140	WR-06 110 – 170	WR-05 140 – 220	WR-03 220 – 325
<b>Test Port Output Power<sup>c</sup></b>	dBm	<b>Minimum Typical</b>	+5 +8	+2 +5	+3 +5	-8 -4	-15 -10	-18 -13	-23
<b>Test Port Input Power at 0.1 dB Compression<sup>d</sup></b>	dBm	<b>Typical</b>	+8	+8	+6	+4	-5	-5	-5
<b>Test Port Match<sup>e</sup></b>	dB	<b>Typical</b>	>17	>17	>17	>17	>15	>15	>9
<b>Residual Source and Load Match</b>	dB	<b>Typical</b>	>35	>35	>35	>35	>35	>35	>33
<b>Test Dynamic Range<sup>e</sup></b>	dB	<b>Minimum Typical</b>	92 >105	92 >105	95 >110	90 >105	80 >95	80 >95	60 >75
<b>Reflection and Transmission Tracking<sup>f</sup></b>	dB Deg	<b>Magnitude Phase</b>	±0.2 ±2	±0.2 ±2	±0.2 ±2	±0.3 ±3	±0.4 ±5	±0.4 ±6	±0.4 ±8
<b>Coupler Directivity<sup>g</sup></b>	dB	<b>Typical</b>	>35	>35	>35	>33	>30	>30	>30
<b>Size<sup>g</sup></b>	in	<b>(L x W x H)</b>	13.0 x 4.3 x 2.7						

a. Specifications are typical and subject to change without notice.  
 b. Test Port Flange Configuration is compatible with MIL-DTL-3922/67D (UG 387/U-M).  
 c. As there are no internationally recognized power standards above 110 GHz, any power data supplied above 110 GHz is traceable only to OML's calorimeter.  
 d. Not Tested.  
 e. Measured at 10 Hz IF bandwidth.



f. At +25 °C. Measured for 1 hr after 1 hr warm-up. Based on “perfect” RF and LO test cables not moved after warm-up and calibration. Not tested.  
 g. Height excludes the adjustable rubber feet; length and depth dimensions exclude the output waveguide length.

## Standard Capabilities for All Configurations

For standard capabilities of the VectorStar VNAs, please see the **VectorStar MS4640B Series VNA Technical Data Sheet – 11410-00611**, available at [www.anritsu.com](http://www.anritsu.com).

## Mechanical and Environmental

### MS4640B Vector Network Analyzer Dimensions without rack mount option

Height	267 mm body (6u) 286 mm between feet outer edges
Width	426 mm body 457 mm between feet outer edges 487 mm between front panel handles outer edges
Depth	502 mm body 591 mm between handle and foot outer edges
Weight	<30 kg (< 66 lbs), Typical weight for a fully-loaded MS4647B VNA

### 3739C Broadband/Millimeter-Wave Test Set Dimensions without rack mount option

Height	89 mm body (2U) 108 mm between feet outer edges
Width	426 mm body 457 mm between feet outer edges 487 mm between front panel handles outer edges
Depth	502 mm body 591 mm between handle and foot outer edges
Weight	5.75 kg

### 3736B Broadband/Millimeter-Wave Test Set Dimensions without rack mount option

Height	89 mm body (2U) 108 mm between feet outer edges
Width	426 mm body 457 mm between feet outer edges 487 mm between front panel handles outer edges
Depth	502 mm body 591 mm between handle and foot outer edges
Weight	5.75 kg

### MN469xC Test Set

Height	89 mm (3u) 108 mm between feet outer edges
Width	426 mm body 444 mm between feet outer edges 487 mm between front panel handles outer edges
Depth	502 mm body 591 mm between handle and foot outer edges
Weight	< 10 kg (fully loaded)

### 3743A Millimeter-Wave Module

Height	21.5 mm
Width	54 mm
Depth	55.3 mm
Weight	0.27 kg

### Environmental – Operating

Conforms to	MIL-PRF-28800F (Class 3).
Temperature Range	0 °C to +50 °C without error codes, except for ‘unleveled’ error messages that may occur at the extreme edges of the temperature range and above
Relative Humidity	5 % to 95 % at +30 °C, Non-condensing
Altitude	4,600 m (15,000 ft)

### Environmental – Non-Operating

Temperature Range	-40 °C to +71 °C
Relative Humidity	0 % to 90 % at +30 °C, Non-condensing
Altitude	4,600 m (15,000 ft)

## Regulatory Compliance

European Union	EMC 2014/30/EU, EN 61326:2013, CISPR 11/EN 55011, IEC/EN 61000-4-2/3/4/5/6/8/11 Low Voltage Directive 2014/35/EU Safety EN 61010-1:2010 RoHS Directive 2011/65/EU applies to instruments with CE marking placed on the market after July 22, 2017.
Australia and New Zealand	RCM AS/NZS 4417:2012
South Korea	KCC-REM-A21-0004

## Warranty

The ME7838A4 4-Port BB/mm-Wave VNA and related accessories offer a 3 year warranty from the date of shipment (excluding OML and VDI modules). Please contact your local service center for additional warranty coverage.

## Calibration and Correction Capabilities

<b>Calibration Methods</b>	Short-Open-Load-Through (SOLT) with Fixed or Sliding Load and supporting .s1p-defined cal kits Offset-Short-Offset-Short-Load-Through (SSLT) with Fixed or Sliding Load Triple-Offset-Short-Through (SSST) Short-Open-Load-Reciprocal (SOLR) or Unknown Through Method (SSLR, SSSR) Line-Reflect-Line (LRL) / Line-Reflect-Match (LRM) – (up to 5 bands supported for multi-line configurations) Advanced-LRM (A-LRM™) for improved on-wafer calibrations mTRL (Multiline TRL) AutoCal Thru Update available Secondary match correction available for improved low insertion loss measurements
<b>Correction Models</b>	Full 2-port (up to two at once), 3-port and 4-port calibrations 1 path/2 port Frequency response (transmission or reflection, any path combination) Reflection only (1, 2, 3, or 4 ports)
<b>Merged Calibration</b>	Merge multiple calibration methods over bands of frequency points. Note that merge does not need to be used for broadband coaxial (SOLT/R-SSST/R) 1 mm or 0.8 mm calibrations using Anritsu calibration kits. These can be done as one unified calibration.
<b>Coefficients for Calibration Standards</b>	Use the Anritsu calibration kit USB Memory Device to load kit coefficients and characterization files. Enter manual coefficients into user-defined locations. Use complex load models.
<b>Reference Impedance</b>	Modify the reference impedance from 50 Ω to any impedance greater than 0 Ω.
<b>Interpolation</b>	Allows interpolation between calibration frequency points. Accuracy will be reduced at non-calibration frequencies and that degradation is dependent on the frequency step size in the initial calibration and the electrical length of the user's setup.
<b>Adapter Removal Calibration</b>	Characterizes and “removes” an adapter that is used during calibration that will not be used for subsequent device measurements; for accurate measurement of non-insertable devices.
<b>Dispersion Compensation</b>	Selectable as Coaxial, other non-dispersive (e.g., for coplanar waveguide), Waveguide, or Microstrip.
<b>Power</b>	
Power Meter Correction	Different power meter calibrations are available to enhance power accuracy at the desired reference plane. The source power will match the target calibration power, as read by the power meter, to within -0.1 dB for short periods of time (determined by thermal drift of the system and the power meter). The absolute accuracy of the calibrated power will be dependent on the power meter and sensor used.
Flat Power Calibrations	A flat power calibration (when in frequency sweep mode) is available at a user-selectable power level, if it is within the power adjustment range of the internal source. The flat power correction is applied to other power levels directly as an offset. Multiple power meters/sensors may be needed depending on the frequency range. An adapter may be required to the 1mm module test port.
Linear Power Calibrations	A linear power calibration is performed over a range of power levels for use in power sweep mode and is performed at a specified frequency or frequency range (for multifrequency gain compression).
External Power Meter	Both calibrations are performed using an external power meter (Anritsu ML2438A, ML248xB, ML249xA, Agilent 437B (or equivalent), Rhode and Schwarz NRP2 meter with a broadband 110 GHz sensor, or Elva DPM power meter) over the Dedicated GPIB port, or a USB power sensor (Anritsu MA24106A, MA24108A, MA24118A, MA24126A, MA24208A, MA24218A, MA24330A, MA24340A, MA24350A, MA24507A, or MA24510A) connected to a USB port. Note: Usage of the MA24500A series sensor requires a dual USB Type A male to single USB Type A female cable to supply needed current draw.
<b>Embedding/De-embedding</b>	The MS4640B is equipped with an Embedding/De-embedding system.
De-embedding	De-embedding is generally used for removal of test fixture contributions, modeled networks and other networks described by S-parameters (s2p files) from measurements.
Embedding	Similarly, the Embedding function can be used to simulate matching circuits for optimizing amplifier designs or simply adding effects of a known structure to a measurement.
Multiple Networks	Multiple networks can be embedded/de-embedded and changing the port and network orientations is handled easily.
Extraction Utility	An extraction utility is part of this package that allows the easier computation of de-embedding files based on some additional calibration steps and measurements.
<b>Impedance Conversion</b>	Allows entry of different impedances (complex values) for different ports.

Mechanical Calibration/Verification Kits

**W1 (1 mm) Calibration/Verification Kit, 3656B**

Provides 12-term SOLT or Triple Offset Short calibrations, for W1 (1 mm) devices, and two verification standards. The -3 options adds .s1p standards definition files for reduced calibration-related uncertainties.



3656B W1 1 mm Calibration/Verification Kit providing 12-Term SOLT or SSST calibrations and two verification standards.

3656B Cal Kit Contains:	Additional Information (Typical)	Quantity	Part Number
Offset Short W1 (male)	Offset: 2.020 mm	1	23W50-1
Offset Short W1 (male)	Offset: 2.650 mm	1	23W50-2
Offset Short W1 (male)	Offset: 3.180 mm	1	23W50-5
Offset Short W1 (female)	Offset: 2.020 mm	1	23WF50-1
Offset Short W1 (female)	Offset: 2.650 mm	1	23WF50-2
Offset Short W1 (female)	Offset: 3.180 mm	1	23WF50-5
Open W1 (male)	Offset: 1.510 mm	1	24W50
Open W1 (female)	Offset: 1.930 mm	1	24WF50
Fixed Termination W1 (male)		1	28W50
Fixed Termination W1 (female)		1	28WF50
Adapter, W1 (male) to Fixed SC <sup>a</sup> Connector		1	33WSC50
Adapter, W1 (female) to Fixed SC <sup>a</sup> Connector		1	33WFSC50
Interchangeable Slider for SC <sup>a</sup> Connector (male)		1	-
Interchangeable Slider for SC <sup>a</sup> Connector (female)		1	-
Locking Keys for SC <sup>a</sup> Connectors		2	-
Pin Exchange Tool for SC <sup>a</sup> Connectors	Contains 1 male pin	1	01-402
Adapter, W1 (male) to W1 (female)		1	33WWF50
Adapter, W1 (male) to W1 (male)		1	33WW50
Adapter, W1 (female) to W1 (female)		1	33WFWF50
Stepped Impedance ThruLine, W1 (male - female)	Verification Device	1	18WWF50-1B
50 Ohm matched ThruLine, W1 (male - female)	Verification Device	1	18WWF50-1
Torque Wrench	6 mm, 5.4 N·cm (4 lbf·in)	1	01-504
Open-ended Wrench	6 mm / 7 mm	1	01-505
Coefficients for standards	On USB Memory Device and 3.5 in Floppy Disk	1	-

a. SC Connectors are a solution for accurate calibrations for non-insertable 1 mm devices. Users can change the gender of the SC connector using the provided tool, pin, sliders, and locking keys to ensure the best pin-depth, thus calibrations are valid after changing the gender of the adapter.

**Test Port Cables**

**Test Port Cables, Flexible, High Performance**

Description	Frequency Range	Impedance	Length (cm)	Insertion Loss (dB)	Return Loss (dB)	Part Number
W1 (1 mm) (male) to W1 (1 mm) (female)	DC to 110 GHz	50 Ω	10	1.74	≥ 14	3671W1-50-1
			13	2.23	≥ 14	3671W1-50-2
			16	2.74	≥ 14	3671W1-50-3



3671W1-50-X Flexible Test Port Cables

**Precision Adapters, Attenuators, and Other Components**

Anritsu offers a complete line of precision adapters and attenuators. For more information, please visit our web site at [www.anritsu.com](http://www.anritsu.com).



**Ordering Information**

The ME7838A4 4-Port Broadband/Millimeter-Wave VNA System provides single sweep coverage from 70 kHz to 110 GHz and consists of the following standard components and optional accessories described in the sections below:

**ME7838A4 4-Port Broadband System, 70 kHz to 110 GHz**

Action	Part Number and Description	Additional Information
Order the base VectorStar model with the listed components and options:	MS4647B, 70 kHz to 70 GHz VNA MS4640B-007, receiver offset MS4640B-070, 70 kHz frequency coverage MN4697C, 4-Port Test Set 3739C, Broadband Test Set with 36 inch interface cables 3736B Broadband/Millimeter-Wave Test Set 3743A, Millimeter-Wave Module, 4 each 806-209-R, 1.85mm coaxial VNA RF cables, 36 in, (m-f), 4 each ME7838A4-SS020, On-site system assembly and verification	
Include the following:	MS4647B-081, MS4647B with ME7838A4 system option and Option 51, or 61, or 62: MS4647B-051 – External VNA Loops MS4647B-061 – Active Measurement Suite, 2 Attenuators MS4647B-062 – Active Measurement Suite, 4 Attenuators	MS4647B-085 is ordered when Option 31 is included
Add options if desired	MS4640B-070 – for 70 kHz operation in base VNA MS4640B-002 – for Time Domain MS464xB-031 – Dual Source Architecture MS4640B-035 – IF Digitizer MS4640B-041 – Noise Figure MS4640B-042 – PulseView™ MS4640B-043 – DifferentialView™ MS4640B-048 – Differential Noise Figure	MS464xB-031 requires Option 85  For other available options, see <a href="#">“ME7838A4 Broadband/Millimeter-Wave System Options”</a>

**ME7838A4 4-Port Waveguide-Band System to 110 GHz – 3744A-EE or 3744A-EW mm-Wave Modules**

Configurator for ME7838A4 Millimeter-Wave System using 3744A-EE or 3744A-EW mm-Wave Modules:

Action	Part Number and Description	Additional Information
Choose and order one of the two base VectorStar models with options listed:	MS4644B VNA, 10 MHz to 40 GHz MS4640B-007 MS4644B-083 or MS4644B-085	MS4644B-085 is ordered when Option 31 is included.
	MS4647B VNA, 10 MHz to 70 GHz MS4647B-007 MS4647B-081 or MS4647B-085	MS4647B-085 is ordered when Option 31 is included.
Order:	MN4697C, 4-Port Test Set 3736B Broadband/Millimeter-Wave Test Set 3739C Broadband/Millimeter-Wave Test Set	
Choose and order Extended-E or Extended-W Band Modules:	3744A-EE, 56 GHz to 94 GHz Extended E Band module, 4 each 3744A-EW, 65 GHz to 110 GHz Extended W Band module, 4 each	
Order one of the following:	Option 51, or 61, or 62: MS464xB-051 – External VNA Loops MS464xB-061 – Active Measurement Suite, 2 Attenuators MS464xB-062 – Active Measurement Suite, 4 Attenuators	ME7838A4 requires Option 51, or 61, or 62
Add options if desired:	MS4640B-070 – for 70 kHz operation in base VNA MS4640B-002 – for Time Domain MS464xB-031 – Dual Source Architecture MS4640B-035 – IF Digitizer MS4640B-041 – Noise Figure MS4640B-042 – PulseView™ MS4640B-043 – DifferentialView™ MS4640B-048 – Differential Noise Figure	MS464xB-031 requires Option 85  For other available options, see <a href="#">“ME7838A4 Broadband/Millimeter-Wave System Options”</a>
Accessories	35WR12WF-EE – Precision Waveguide to Coax Adapter Kit, 56 GHz to 94 GHz, WR-12 to W1 (f)	
	35WR10WF-EW – Precision Waveguide to Coax Adapter Kit, 65 GHz to 110 GHz, WR-10 to W1 (f)	

**ME7838A4 4-Port Waveguide-Band System – OML/VDI mm-Wave Modules**

ME7838A4 4-Port Waveguide-Band System using OML or VDI Millimeter-Wave modules:

Action	Part Number and Description	Additional Information
Choose and order one of the three base VectorStar models with options listed:	MS4642B VNA, 70 kHz to 20 GHz MS4642B-061 or MS4642B-062 MS4642B-083	MS4642B-061 includes Active Device Measurements, with 2 Step Attenuators MS4642B-062 includes Active Device Measurements, with 4 Step Attenuators MS4642B-085 is ordered when Option 31 is included.
	MS4644B VNA, 10 MHz to 40 GHz MS4640B-007 Receiver Offset MS4644B-083	MS4644B-085 is ordered when Option 31 is included.
	MS4647B VNA, 10 MHz to 70 GHz MS4640B-007 Receiver Offset MS4647B-081	MS4647B-085 is ordered when Option 31 is included.
Order:	MN469xC, 4-port Test Set 3739C Broadband/Millimeter-Wave Test Set 3736B Broadband/Millimeter-Wave Test Set	
	SM6537 Interface Cables (4) for OML/VDI mm-Wave Modules	Does not include DC cable. DC supply is provided by mm-Wave module power supply.
Choose and order one of the two appropriate millimeter-wave module combinations:	4 each TxRx transmission and reflection millimeter-wave modules	Choose appropriate OML or VDI modules. Contact Anritsu Company for ordering information.
For MS4644B or MS4647B, order:	Option 51, or 61, or 62: MS464xB-051 – External VNA Loops MS464xB-061 – Active Measurement Suite, 2 Attenuators MS464xB-062 – Active Measurement Suite, 4 Attenuators	ME7838A4 requires Option 51, or 61, or 62
Add options if desired:	MS4640B-070 – for 70 kHz operation in base VNA MS4640B-002 – for Time Domain MS464xB-031 – Dual Source Architecture MS4640B-035 – IF Digitizer MS4640B-041 – Noise Figure MS4640B-042 – PulseView™ MS4640B-043 – DifferentialView™ MS4640B-048 – Differential Noise Figure	MS464xB-031 requires Option 85  For other available options, see <a href="#">“ME7838A4 Broadband/Millimeter-Wave System Options”</a>

**Calibration/Verification Kits**

3656B	W1 (1 mm) Calibration/Verification Kit
3656B-3	W1 (1 mm) Calibration/Verification Kit, With .s1p Characterization Files
3655V	WR-15 Waveguide Calibration Kit, Without Sliding Loads
3655V-1	WR-15 Waveguide Calibration Kit, With Sliding Loads
3655E	WR-12 Waveguide Calibration Kit, Without Sliding Loads
3655E-1	WR-12 Waveguide Calibration Kit, With Sliding Loads
3655W	WR-10 Waveguide Calibration Kit, Without Sliding Loads
3655W-1	WR-10 Waveguide Calibration Kit, With Sliding Loads
3650A	SMA/3.5 mm Calibration Kit, Without Sliding Loads
3650A-1	SMA/3.5 mm Calibration Kit, With Sliding Loads
3652A	K Calibration Kit, With Pin Depth Gauge
3652A-2	K Calibration Kit, With No Pin Depth Gauge
3652A-3	K Calibration Kit, With Pin Depth Gauge and .s1p Characterization Files
3652A-4	K Calibration Kit, With .s1p Characterization Files
3654D	V Calibration Kit, With Pin Depth Gauge
3654D-2	V Calibration Kit, With No Pin Depth Gauge
3654D-3	V Calibration Kit, With Pin Depth Gauge and .s1p Characterization Files
3654D-4	V Calibration Kit, With .s1p Characterization Files
3657	V Multi-Line Calibration Kit, Without Shorts
3657-1	V Multi-Line Calibration Kit, With Shorts

**External Power Meters/Sensors**

ML243xA	CW Power Meter, Single Input or Dual Input Recommended Power Sensors: • SC7770 • MA247xD • MA244xD • MA248xD • MA2400xA
ML248xB	Wideband Power Meter, Single Input or Dual Input Recommended Power Sensors: • MA249xA • MA2411B
ML249xA	Pulse Power Meter, Single Input or Dual Input Recommended Power Sensors: • MA249xA • MA2411B
MA24106A	USB Power Sensor, 50 MHz to 6 GHz
MA24108A	USB Power Sensor, 10 MHz to 8 GHz
MA24118A	USB Power Sensor, 10 MHz to 18 GHz
MA24126A	USB Power Sensor, 10 MHz to 26 GHz
MA24330A	USB Power Sensor, 10 MHz to 33 GHz
MA24340A	USB Power Sensor, 10 MHz to 40 GHz
MA24350A	USB Power Sensor, 10 MHz to 50 GHz
MA24507A	Power Master™ Frequency Selectable mm-Wave Power Analyzer, 9 kHz to 70 GHz
MA24510A	Power Master™ Frequency Selectable mm-Wave Power Analyzer, 9 kHz to 110 GHz Note that usage of the MA24507A or MA24510A Power Master™ sensor requires connection to two USB ports to supply needed current draw.

**Test Port Cables, Flexible, High Performance**

3671W1-50-1	W1 (male) to W1 (female), 1 each, 10.0 cm (3.9 in)
3671W1-50-2	W1 (male) to W1 (female), 1 each, 13.0 cm (5.1 in)
3671W1-50-3	W1 (male) to W1 (female), 1 each, 16.0 cm (6.3 in)
3671KFS50-60	K (female) to 3.5 mm (male) cable, 60 cm (one cable)
3671KFK50-60	K (female) to K (male) cable, 60 cm (one cable)
3671KFK50-100	K (female) to K (male) cable, 1 each, 100 cm (one cable)
3671KFKF50-60	K (female) to K (female) cable, 1 each, 60 cm (one cable)
3671VVF50-60	V (female) to V (male) cable, 1 each, 60 cm (one cable)
3671VVF50-100	V (female) to V (male) cable, 1 each, 100 cm (one cable)
3671KFSF50-60	K (female) to 3.5 mm (female) cable, 1 each, 60 cm (one cable)
3671VVF50-60	V (female) to V (female) cable, 1 each, 60 cm (one cable)

**Adapters**

34WV50	W1 (male) to V (male) Adapter, W1 (1 mm) to V, Coaxial
34WVF50	W1 (male) to V (female) Adapter, W1 (1 mm) to V, Coaxial
34WFV50	W1 (female) to V (male) Adapter, W1 (1 mm) to V, Coaxial
34WVVF50	W1 (female) to V (female) Adapter, W1 (1 mm) to V, Coaxial
33WW50	W1 (male) to W1 (male) Adapter, W1 (1 mm) in-series, Coaxial
33WVF50	W1 (male) to W1 (female) Adapter, W1 (1 mm) in-series, Coaxial
33WVVF50	W1 (female) to W1 (female) Adapter, W1 (1 mm) in-series, Coaxial
35WR10W	WR10 to W1 (male) Adapter, W1 (1mm) to WR10 Waveguide
35WR10WF	WR10 to W1 (female) Adapter, W1 (1mm) to WR10 Waveguide
SC7260	WR12 to W1 (male) Adapter, W1 (1 mm) to WR12 Waveguide
SC7442	WR12 to W1 (female) Adapter, W1 (1 mm) to WR12 Waveguide
35WR15V	WR15 to V (male) Adapter, V (1.85mm) to WR15 Waveguide
35WR15VF	WR15 to V (female) Adapter, V (1.85mm) to WR15 Waveguide
For More Information	Refer to our <b>Precision RF &amp; Microwave Components Catalog</b> for descriptions of adapters and other components.

**Miscellaneous Components**

41W-3	Attenuator, DC to 110 GHz, 0.2 W, 3 dB, W1(m) to W1(f), 50 Ω
41W-6	Attenuator, DC to 110 GHz, 0.2 W, 6 dB, W1(m) to W1(f), 50 Ω
41W-10	Attenuator, DC to 110 GHz, 0.2 W, 10 dB, W1(m) to W1(f), 50 Ω
W240A	Precision Power Divider, DC to 110 GHz, W1(f) input, W1(f) outputs, 3 resistor, 50 Ω
W241A	Precision Power Splitter, DC to 110 GHz, W1(m) input, W1(f) outputs, 2 resistor, 50 Ω
MN25110A	Precision Directional Coupler, 20 GHz to 110 GHz, W1(f) input, W1(f) output, W1(f) coupled port, 50 Ω

**Accessories**

SC8215	Kelvin Bias Tee, low frequency limit: 70 kHz, Max Voltage: 16 VDC, Max Current: 100 mA
SC7287	Kelvin Bias Tee, low frequency limit: 100 MHz, Max Voltage: 50 VDC, Max Current: 500 mA
SC8218	Triax (male) to SMC (female) Cable, (Inner-shield floating at SMC end), 1.5 m (60 in) long two (2) needed per Kelvin Bias Tee
SM6494	System floor console. Includes larger size writing table
2100-1	GPIB cable, 1 m (39 in) long
2100-2	GPIB cable, 2 m (79 in) long
2100-4	GPIB cable, 4 m (157 in) long
806-206-R	Flexible Coaxial Cable, DC to 70 GHz, 24 in (61 cm), V(m) – V(f), 50Ω, for connecting the VNA and the 3743A Modules
806-209-R	Flexible Coaxial Cable, DC to 70 GHz, 36 in (91.5 cm), V(m) – V(f), 50Ω, for connecting the VNA and the 3743A Modules
01-201	Torque Wrench (for tightening male devices), 8 mm (5/16 in), 0.9 N·m (8 lbf·in) for SMA, 3.5 mm, 2.4 mm, K, and V connectors
01-202	Universal Test Port Connector Wrench
01-203	Torque Wrench (for tightening the VNA test ports to female devices) 20.6 mm (13/16 in), 0.9 N·m (8 lbf·in)
01-204	Anritsu Stainless Steel Connector Wrench, circular, open-ended for SMA, 3.5 mm, 2.4 mm, K and V connectors
01-529-R	Torque Wrench, 4 mm (5/32 in), 0.17 N·m (1.5 lbf·in) (for tightening the test and reference IF connectors on the mm-Wave modules)
01-504	Torque wrench (for tightening male devices) 6 mm, 0.45 N·m (4 lbf·in) for 1.0 mm and 0.8 mm connectors
01-524	Low-profile Torque Wrench (for tightening male devices), 6 mm, 0.45 N·m (4 lbf·in), 126 mm long for 1.0 mm and 0.8 mm connectors

Contact Anritsu regarding rack mount options [www.anritsu.com](http://www.anritsu.com).



## Training at Anritsu

Anritsu has designed courses to help you stay up to date with technologies important to your job. For available training courses, visit: [www.anritsu.com/training](http://www.anritsu.com/training)



### • United States

**Anritsu Americas Sales Company**  
450 Century Parkway, Suite 190  
Allen, TX 75013, U.S.A.  
Phone: +1-800-Anritsu (1-800-267-4878)

### • Canada

**Anritsu Electronics Ltd.**  
700 Silver Seven Road, Suite 120  
Kanata, Ontario K2V 1C3, Canada  
Phone: +1-613-591-2003  
Fax: +1-613-591-1006

### • Brazil

**Anritsu Eletronica Ltda.**  
Praça Amadeu Amaral, 27 - 1 Andar  
01327-010 - Bela Vista - Sao Paulo - SP  
Brazil  
Phone: +55-11-3283-2511  
Fax: +55-11-3288-6940

### • Mexico

**Anritsu Company, S.A. de C.V.**  
Blvd Miguel de Cervantes Saavedra #169 Piso 1,  
Col. Granada  
Mexico, Ciudad de Mexico, 11520, MEXICO  
Phone: +52-55-4169-7104

### • United Kingdom

**Anritsu EMEA L td.**  
200 Capability Green  
Luton, Bedfordshire, LU1 3LU, U.K.  
Phone: +44-1582-433200  
Fax: +44-1582-731303

### • France

**Anritsu S.A.**  
12 avenue du Québec, Bâtiment Iris 1- Silic 612,  
91140 Villebon-sur-Yvette, France  
Phone: +33-1-60-92-15-50  
Fax: +33-1-64-46-10-65

### • Germany

**Anritsu GmbH**  
Nemetschek Haus, Konrad-Zuse-Platz 1  
81829 München, Germany  
Phone: +49-89-442308-0  
Fax: +49-89-442308-55

### • Italy

**Anritsu S.r.l.**  
Via Elio Vittorini 129, 00144 Roma, Italy  
Phone: +39-6-509-9711  
Fax: +39-6-502-2425

List Revision Date: 20191126

### • Sweden

**Anritsu AB**  
Isafjordsgatan 32C  
164 40 Kista, Sweden  
Phone: +46-8-534-707-00

### • Finland

**Anritsu AB**  
Teknobulevardi 3-5  
FI-01530 Vantaa, Finland  
Phone: +358-20-741-8100  
Fax: +358-20-741-8111

### • Denmark

**Anritsu A/S**  
c/o Regus Fairway, Arne Jacobsens Allé 7, 5th floor,  
2300 Copenhagen S, Denmark  
Phone: +45-7211-2200

### • Russia

**Anritsu EMEA Ltd.**  
**Representation Office in Russia**  
Tverskaya str. 16/2, bld. 1, 7th floor  
Moscow 125009, Russia  
Phone: +7-495-363-1694  
Fax: +7-495-935-8962

### • Spain

**Anritsu EMEA Ltd.**  
**Representation Office in Spain**  
Paseo de la Castellana, 141.  
Planta 5, Edificio Cuzco IV  
28046, Madrid, Spain  
Phone: +34-91-572-6761

### • United Arab Emirates

**Anritsu EMEA Ltd.**  
**Dubai Liaison Office**  
902 Aurora Tower  
P O Box: 500311- Dubai Internet City  
Dubai, United Arab Emirates  
Phone: +971-4-3758479  
Fax: +971-4-4249036

### • India

**Anritsu India Private Limited**  
6th Floor, Indiqube ETA, No.38/4  
Adjacent to EMC2, Doddanekundi, Outer Ring Road  
Bengaluru 560048, India  
Phone: +91-80-6728-1300  
Fax: +91-80-6728-1301

### • Singapore

**Anritsu Pte. Ltd.**  
11 Chang Charn Road, #04-01, Shriro House  
Singapore 159640  
Phone: +65-6282-2400  
Fax: +65-6282-2533

### • P.R. China (Shanghai)

**Anritsu (China) Co., Ltd.**  
Room 2701-2705, Tower A  
New Caohejing International Business Center  
No. 391 Gui Ping Road  
Shanghai 200233, P.R. China  
Phone: +86-21-6237-0898  
Fax: +86-21-6237-0899

### • P.R. China (Hong Kong)

**Anritsu Company Ltd.**  
Unit 1006-7, 10/F.  
Greenfield Tower, Concordia Plaza  
No. 1 Science Museum Road  
Tsim Sha Tsui East, Kowloon  
Hong Kong, P.R. China  
Phone: +852-2301-4980  
Fax: +852-2301-3545

### • Japan

**Anritsu Corporation**  
8-5, Tamura-cho, Atsugi-shi, Kanagawa, 243-0016  
Japan  
Phone: +81-46-296-6509  
Fax: +81-46-225-8352

### • South Korea

**Anritsu Corporation, Ltd.**  
5FL, 235 Pangyoeyeok-ro  
Bundang-gu, Seongnam-si  
Gyeonggi-do 13494, South Korea  
Phone: +82-31-696-7750  
Fax: +82-31-696-7751

### • Australia

**Anritsu Pty. Ltd.**  
Unit 20, 21-35 Ricketts Road  
Mount Waverley, Victoria 3149, Australia  
Phone: +61-3-9558-8177  
Fax: +61-3-9558-8255

### • Taiwan

**Anritsu Company Inc.**  
7F, No. 316, Sec. 1, NeiHu Rd. Taipei 114, Taiwan  
Phone: +886-2-8751-1816  
Fax: +886-2-8751-1817