

DATASHEET

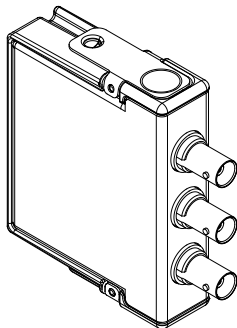

NI 9232

3 AI, ± 30 V, 24 Bit, 102.4 kS/s/ch Simultaneous

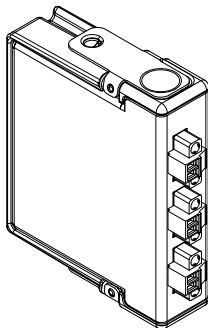

- Screw-terminal or BNC connectivity
- Software-selectable AC/DC coupling
- Software-selectable IEPE signal conditioning (0 mA or 4 mA)
- Smart TEDS sensor compatibility
- 60 VDC, CAT I, channel-to-earth isolation

The NI 9232 is a 3-channel C Series dynamic signal acquisition module for making industrial measurements from integrated electronic piezoelectric (IEPE) and non-IEPE sensors with NI CompactDAQ or NI CompactRIO systems.

 <p>Kit Contents</p>	<ul style="list-style-type: none">• NI 9232• NI 9232 Getting Started Guide
 <p>Accessories</p>	<p>Required</p> <ul style="list-style-type: none">• EMI suppression ferrite (782802-01) (for screw terminal) <p>Recommended</p> <ul style="list-style-type: none">• NI 9971 Backshell Kit (for screw terminal)

C SERIES DYNAMIC SIGNAL ACQUISITION MODULE COMPARISON							
Product Name	Signal Ranges	Channels	Sample Rate	Input Configurations	Noise at Maximum Sample Rate	Connectivity	Isolation Continuous
NI 9218	±5 V	2	51.2 kS/s/ch	IEPE with AC Coupling	50 μ Vrms	9-Position DSUB, LEMO	60 VDC Ch-Ch
NI 9230	±30 V	3	12.8 kS/s/ch	IEPE with AC Coupling, AC Coupling, DC Coupling	106 μ Vrms	Screw Terminal, BNC	60 VDC Ch-Earth
NI 9232	±30 V	3	102.4 kS/s/ch	IEPE with AC Coupling, AC Coupling, DC Coupling	251 μ Vrms	Screw Terminal, BNC	60 VDC Ch-Earth
NI 9234	±5 V	4	51.2 kS/s/ch	IEPE with AC Coupling, AC Coupling, DC Coupling	50 μ Vrms	BNC	None
NI 9251	3 Vrms (\pm 4.243 V)	2	102.4 kS/s/ch	AC Coupling, DC Coupling	9.2 μ Vrms	mini XLR	None

NI C Series Overview



NI provides more than 100 C Series modules for measurement, control, and communication applications. C Series modules can connect to any sensor or bus and allow for high-accuracy measurements that meet the demands of advanced data acquisition and control applications.

- Measurement-specific signal conditioning that connects to an array of sensors and signals
- Isolation options such as bank-to-bank, channel-to-channel, and channel-to-earth ground
- -40 °C to 70 °C temperature range to meet a variety of application and environmental needs
- Hot-swappable

The majority of C Series modules are supported in both CompactRIO and CompactDAQ platforms and you can move modules from one platform to the other with no modification.

CompactRIO



CompactRIO combines an open-embedded architecture with small size, extreme ruggedness, and C Series modules in a platform powered by the NI LabVIEW reconfigurable I/O (RIO) architecture. Each system contains an FPGA for custom timing, triggering, and processing with a wide array of available modular I/O to meet any embedded application requirement.

CompactDAQ

CompactDAQ is a portable, rugged data acquisition platform that integrates connectivity, data acquisition, and signal conditioning into modular I/O for directly interfacing to any sensor or signal. Using CompactDAQ with LabVIEW, you can easily customize how you acquire, analyze, visualize, and manage your measurement data.



Software

LabVIEW Professional Development System for Windows



- Use advanced software tools for large project development
- Generate code automatically using DAQ Assistant and Instrument I/O Assistant
- Use advanced measurement analysis and digital signal processing
- Take advantage of open connectivity with DLLs, ActiveX, and .NET objects
- Build DLLs, executables, and MSI installers

NI LabVIEW FPGA Module



- Design FPGA applications for NI RIO hardware
- Program with the same graphical environment used for desktop and real-time applications
- Execute control algorithms with loop rates up to 300 MHz
- Implement custom timing and triggering logic, digital protocols, and DSP algorithms
- Incorporate existing HDL code and third-party IP including Xilinx IP generator functions
- Purchase as part of the LabVIEW Embedded Control and Monitoring Suite

NI LabVIEW Real-Time Module



- Design deterministic real-time applications with LabVIEW graphical programming
- Download to dedicated NI or third-party hardware for reliable execution and a wide selection of I/O
- Take advantage of built-in PID control, signal processing, and analysis functions
- Automatically take advantage of multicore CPUs or set processor affinity manually
- Take advantage of real-time OS, development and debugging support, and board support
- Purchase individually or as part of a LabVIEW suite

Circuitry

The NI 9232 analog input channels are referenced to an isolated ground through a 50 Ω resistor. Each channel is protected from overvoltages. The input signal on each channel is buffered, conditioned, and then sampled by an isolated 24-bit Delta-Sigma ADC. You can configure each channel in software for AC or DC coupling. For channels set to AC coupling, you can turn the IEPE excitation current on or off. Refer to the software help for information about configuring channels on the NI 9232.

Figure 1. Input Circuitry for One Channel

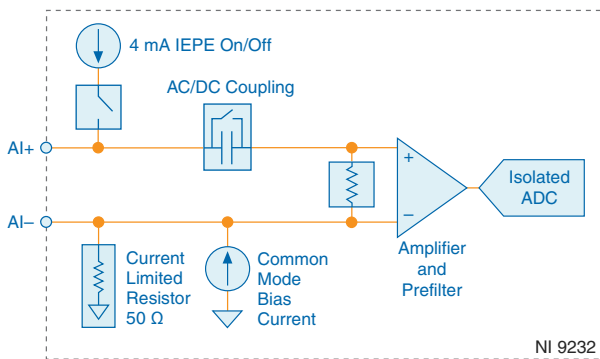

The NI 9232 also has TEDS circuitry. For more information about TEDS, visit ni.com/info and enter the Info Code `rdteds`.

Filtering

The NI 9232 uses a combination of analog and digital filtering to provide an accurate representation of in-band signals while rejecting out-of-band signals. The filters discriminate

between signals based on the frequency range, or bandwidth, of the signal. The three important bandwidths to consider are the passband, the stopband, and the alias-free bandwidth.

The NI 9232 represents signals within the passband, as quantified primarily by passband ripple and phase nonlinearity. All signals that appear in the alias-free bandwidth are either unaliased signals or signals that have been filtered by at least the amount of the stopband rejection.

Passband

The signals within the passband have frequency-dependent gain or attenuation. The small amount of variation in gain with respect to frequency is called the passband flatness. The digital filters of the NI 9232 adjust the frequency range of the passband to match the data rate. Therefore, the amount of gain or attenuation at a given frequency depends on the data rate.

Figure 2. Typical Passband Flatness

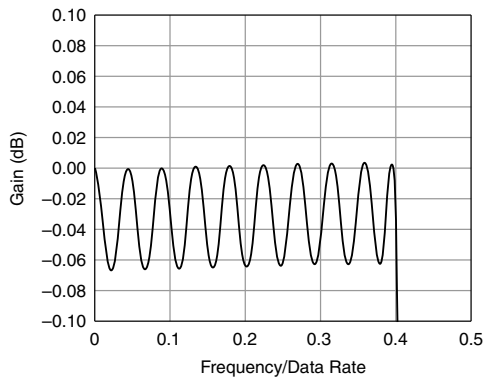

Stopband

The filter significantly attenuates all signals above the stopband frequency. The primary goal of the filter is to prevent aliasing. Therefore, the stopband frequency scales precisely with the data rate. The stopband rejection is the minimum amount of attenuation applied by the filter to all signals with frequencies within the stopband.

Alias-Free Bandwidth

Any signal that appears in the alias-free bandwidth of the NI 9232 is not an aliased artifact of signals at a higher frequency. The alias-free bandwidth is defined by the ability of the filter to reject frequencies above the stopband frequency, and it is equal to the data rate minus the stopband frequency.

Data Rates

The frequency of a master timebase (f_M) controls the data rate (f_s) of the NI 9232.

Internal Master Timebase

The NI 9232 includes an internal master timebase with a frequency of 13.1072 MHz. When using the internal master timebase, the result is data rates of 102.4 kS/s, 51.2 kS/s, 34.13 kS/s, 25.6 kS/s, and so on down to 0.98 kS/s, depending on the decimation rate and the value of the clock divider. However, the data rate must remain within the appropriate data rate range.

The following equation provides the available data rates of the NI 9232:

$$f_s = \frac{f_M}{2 \times m \times n}$$

where

f_s is the data rate

f_M is the master timebase

m is the decimation rate

n is the clock divider from 1 to 26

There are multiple combinations of clock divider and decimation rate that yield the same data rate. The software always picks the highest decimation rate for the selected data rate.

Data Rates with the Internal Master Timebase

The following table lists the available data rates with the internal master timebase.

Table 1. Available Data Rates with the Internal Master Timebase

f_s (kS/s)	Decimation Rate	Clock Divider
102.40	64	1
51.20	128	1
34.13	64	3
25.60	256	1
20.48	64	5
17.07	128	3
14.63	64	7
12.80	256	2
11.38	64	9

Table 1. Available Data Rates with the Internal Master Timebase (Continued)

f_s (kS/s)	Decimation Rate	Clock Divider
10.24	128	5
9.31	64	11
8.53	256	3
7.88	64	13
7.31	128	7
6.83	64	15
6.40	256	4
6.02	64	17
5.69	128	9
5.39	64	19
5.12	256	5
4.88	64	21
4.65	128	11
4.45	64	23
4.27	256	6
4.10	64	25
3.94	128	13
3.66	256	7
3.41	128	15
3.20	256	8
3.01	128	17
2.84	256	9
2.69	128	19
2.56	256	10
2.44	128	21

Table 1. Available Data Rates with the Internal Master Timebase (Continued)

f_s (kS/s)	Decimation Rate	Clock Divider
2.33	256	11
2.23	128	23
2.13	256	12
2.05	128	25
1.97	256	13
1.83	256	14
1.71	256	15
1.60	256	16
1.51	256	17
1.42	256	18
1.35	256	19
1.28	256	20
1.22	256	21
1.16	256	22
1.11	256	23
1.07	256	24
1.02	256	25
0.98	256	26

External Master Timebase

The NI 9232 also can accept an external master timebase or export its own master timebase. To synchronize the data rate of an NI 9232 with other modules that use master timebases to control sampling, all of the modules must share a single master timebase source. When using an external timebase with a frequency other than 13.1072 MHz, the NI 9232 has a different set of data rates. Refer to the software help for information about configuring the master timebase source for the NI 9232.



Note The NI 9151 R Series Expansion chassis does not support sharing timebases between modules.

NI 9232 Specifications

The following specifications are typical for the range -40 °C to 70 °C unless otherwise noted.



Caution Do not operate the NI 9232 in a manner not specified in this document. Product misuse can result in a hazard. You can compromise the safety protection built into the product if the product is damaged in any way. If the product is damaged, return it to NI for repair.

Input Characteristics

Number of channels	3 analog input channels
ADC resolution	24 bits
Type of ADC	Delta-Sigma (with analog prefiltering)
Sampling mode	Simultaneous
Type of TEDS supported	IEEE 1451.4 TEDS Class I
TEDS capacitive drive	3000 pF
Internal master timebase (f_M)	
Frequency	13.1072 MHz
Accuracy	±100 ppm
Data rate range (f_s) using internal master timebase	
Minimum	0.985 kS/s
Maximum	102.4 kS/s
Data rate range (f_s) using external master timebase	
Minimum	0.977 kS/s
Maximum	102.73 kS/s

Figure 3. Data Rates (f_s)

$$\frac{f_M}{2 \times m \times n}$$

Input coupling	AC/DC (software-selectable)
AC cutoff frequency	
-3 dB	0.1 Hz
-0.1 dB	0.87 Hz maximum

Figure 4. AC Cutoff Frequency Response

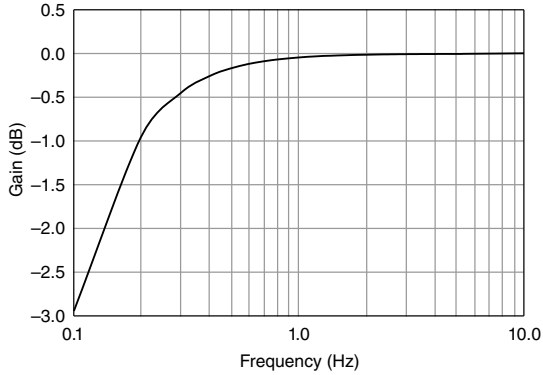

DC voltage input range

Minimum	±30.87 V
Typical	±31.5 V
Maximum	±32.13 V

AC voltage full-scale range¹

Minimum	±30.87 Vpk
Typical	±31.5 Vpk
Maximum	±32.13 Vpk

Channel-to-channel common-mode voltage range (AI- to AI-) ±1 V maximum

IEPE excitation current (software-selectable on/off)

Minimum	4 mA
Typical	4.25 mA

IEPE excitation noise 100 nArms

IEPE compliance voltage 22 V minimum

If you are using an IEPE sensor, use the following equation to make sure your configuration meets the IEPE compliance voltage range.

Figure 5. IEPE Compliance Voltage Range

$$(0.67 \times V_{\text{common-mode}} + V_{\text{bias}} \pm V_{\text{full-scale}})$$

¹ The DC + AC voltage must be below the overvoltage protection of the NI 9232.

where

$V_{\text{common-mode}}$ is the channel-to-channel common-mode voltage across two or more channels

V_{bias} is the bias voltage of the IEPE sensor

$V_{\text{full-scale}}$ is the full-scale voltage of the IEPE sensor



Note This equation must resolve to 0 V to 22 V.

IEPE fault detection²

Short circuit	$V_{AI} < 1.5 \text{ V}$
Open loop	$V_{AI} > 24 \text{ V}$
Overvoltage protection	$\pm 45 \text{ V}$ for a low impedance source connected between any two terminals

Input delay

64x decimation	$30/f_s + 3.0 \text{ }\mu\text{s}$
128x decimation	$29/f_s + 3.0 \text{ }\mu\text{s}$
256x decimation	$28/f_s + 3.0 \text{ }\mu\text{s}$

Table 2. Accuracy

Measurement Conditions		Percent of Reading (Gain Error)	Percent of Range ³ (Offset Error) ⁴
Calibrated	Maximum (-40 °C to 70 °C)	$\pm 0.60\%$	$\pm 0.23\%$
	Typical (23 °C, $\pm 5 \text{ }^\circ\text{C}$)	$\pm 0.10\%$	$\pm 0.023\%$
Uncalibrated ⁵	Maximum (-40 °C to 70 °C)	$\pm 1.50\%$	$\pm 0.59\%$
	Typical (23 °C, $\pm 5 \text{ }^\circ\text{C}$)	$\pm 0.40\%$	$\pm 0.12\%$

Stability

Gain drift	$\pm 25 \text{ ppm}/^\circ\text{C}$
Offset drift (DC coupled)	$\pm 320 \text{ }\mu\text{V}/^\circ\text{C}$

² Refer to the software help for information on reading the IEPE fault detection status.

³ Range equals 31.5 V

⁴ DC coupled

⁵ Uncalibrated accuracy refers to the accuracy achieved when acquiring data in raw or unscaled modes and in which calibration constants that are stored in the module are not applied to the data.

Table 3. Gain Matching (Calibrated)

Frequency Band	20 Hz to 40.96 kHz	
	Typical	Maximum
Channel-to-channel	25 mdB	120 mdB

Table 4. Phase Matching (Maximum)

Frequency Band	20 Hz to 40.96 kHz
Channel-to-channel	$(0.022^\circ/\text{kHz} \times f_{\text{in}}) + 0.045^\circ$
Module-to-module	$(0.022^\circ/\text{kHz} \times f_{\text{in}}) + 0.045^\circ + (360^\circ \times f_{\text{in}} / f_M)$

Passband frequency	$0.4 \cdot f_s$
--------------------	-----------------

Table 5. Flatness (Peak-to-Peak)

Frequency Band	20 Hz to 20.48 kHz	20 Hz to 40.96 kHz
Typical	70 mdB	75 mdB
Maximum	75 mdB ⁶	100 mdB ⁷

Table 6. Phase Nonlinearity (Maximum)

Frequency Band	20 Hz to 20.48 kHz	20 Hz to 40.96 kHz
AC Coupled	0.31°	0.31°
DC Coupled	0.025°	0.19°

Stopband	
----------	--

Frequency	$0.5 \cdot f_s$
-----------	-----------------

Rejection	120 dB
-----------	--------

Alias-free bandwidth	$0.4 \cdot f_s$
----------------------	-----------------

Oversample rate	$64 \cdot f_s$, $128 \cdot f_s$, and $256 \cdot f_s$
-----------------	--

⁶ For conformed version, the maximum flatness for 20 Hz to 20.48 kHz is 76 mdB.

⁷ For conformed coated version, the maximum flatness for 20 Hz to 40.96 kHz is 102 mdB.

Rejection at oversample rate⁸

$f_s = 10.24 \text{ kS/s}$	95 dB at 1.311 MHz
$f_s = 102.4 \text{ kS/s}$	120 dB at 6.554 MHz
Crosstalk ($f_{in} = 1 \text{ kHz}$)	-125 dB
CMRR	
Channel-to-channel ($f_{in} \leq 1 \text{ kHz}$)	56 dB
Channel-to-earth ($f_{in} = 60 \text{ Hz}$)	107 dB
SFDR ($f_{in} = 1 \text{ kHz}, -60 \text{ dBFS}$)	
$f_s = 102.4 \text{ kS/s}$	120 dBFS
$f_s = 51.2 \text{ kS/s}$	123 dBFS
$f_s = 25.6 \text{ kS/s}$	126 dBFS

Table 7. Input Noise

Data Rate	102.4 kS/s	51.2 kS/s	25.6 kS/s
AC coupled	251 μVrms	171 μVrms	127 μVrms
DC coupled	223 μVrms	150 μVrms	112 μVrms

Table 8. Dynamic range ($f_{in} = 1 \text{ kHz}, -60 \text{ dBFS}$)

Data Rate	102.4 kS/s	51.2 kS/s	25.6 kS/s
AC coupled	99 dBFS	102 dBFS	105 dBFS
DC coupled	100 dBFS	103 dBFS	106 dBFS

Input impedance

Differential	324 k Ω
AI- to isolated ground	50 Ω

⁸ Rejection of analog prefilter at oversample rate.

Table 9. Total Harmonic Distortion (THD)

Input Amplitude	1 kHz	10 kHz
-10.5424 dBFS	-95 dB	-85 dB
-20 dBFS	-95 dB	-85 dB

Intermodulation distortion (-10.5424 dBFS)

DIN 250 Hz/8 kHz 4:1 amplitude ratio -80 dB

CCIF 11 kHz/12 kHz 1:1 amplitude ratio -100 dB

Power Requirements

Power consumption from chassis

Active mode 1 W maximum

Sleep mode 25 μ W maximum

Thermal dissipation (at 70 °C)

Active mode 1 W maximum

Active mode (BNC variant) 1.5 W maximum

Sleep mode 25 μ W maximum

Physical Characteristics

If you need to clean the module, wipe it with a dry towel.



Tip For two-dimensional drawings and three-dimensional models of the C Series module and connectors, visit ni.com/dimensions and search by module number.

Screw-terminal wiring

Gauge 0.05 mm² to 1.5 mm² (30 AWG to 14 AWG) copper conductor wire

Wire strip length 6 mm (0.24 in.) of insulation stripped from the end

Temperature rating 90 °C minimum

Torque for screw terminals 0.22 N · m to 0.25 N · m (1.95 lb · in. to 2.21 lb · in.)

Wires per screw terminal One wire per screw terminal; two wires per screw terminal using a 2-wire ferrule

Ferrules 0.25 mm² to 1.5 mm²

Connector securement

Securement type	Screw flanges provided
Torque for screw flanges	0.2 N · m (1.80 lb · in.)
Weight	
NI 9232 with screw terminal	142 g (5.0 oz)
NI 9232 with BNC	159 g (5.6 oz)

Safety Voltages

Connect only voltages that are within the following limits.

Isolation

Channel-to-channel	None
Channel-to-earth ground	
Continuous	60 VDC, Measurement Category I
Withstand	1,000 Vrms, verified by a 5 s dielectric withstand test

Measurement Category I is for measurements performed on circuits not directly connected to the electrical distribution system referred to as *MAINS* voltage. MAINS is a hazardous live electrical supply system that powers equipment. This category is for measurements of voltages from specially protected secondary circuits. Such voltage measurements include signal levels, special equipment, limited-energy parts of equipment, circuits powered by regulated low-voltage sources, and electronics.



Caution Do not connect the NI 9232 to signals or use for measurements within Measurement Categories II, III, or IV.



Note Measurement Categories CAT I and CAT O are equivalent. These test and measurement circuits are not intended for direct connection to the MAINS building installations of Measurement Categories CAT II, CAT III, or CAT IV.

Hazardous Locations

U.S. (UL)	Class I, Division 2, Groups A, B, C, D, T4; Class I, Zone 2, AEx nA IIC T4
Canada (C-UL)	Class I, Division 2, Groups A, B, C, D, T4; Class I, Zone 2, Ex nA IIC T4
Europe (ATEX) and International (IECEX)	Ex nA IIC T4 Gc

Safety and Hazardous Locations Standards

This product is designed to meet the requirements of the following electrical equipment safety standards for measurement, control, and laboratory use:

- IEC 61010-1, EN 61010-1
- UL 61010-1, CSA 61010-1
- EN 60079-0:2012, EN 60079-15:2010
- IEC 60079-0: Ed 6, IEC 60079-15; Ed 4
- UL 60079-0; Ed 6, UL 60079-15; Ed 4
- CSA 60079-0:2011, CSA 60079-15:2012



Note For UL and other safety certifications, refer to the product label or the [Online Product Certification](#) section.

Electromagnetic Compatibility

This product meets the requirements of the following EMC standards for electrical equipment for measurement, control, and laboratory use:

- EN 61326-1 (IEC 61326-1): Class A emissions; Industrial immunity
- EN 55011 (CISPR 11): Group 1, Class A emissions
- EN 55022 (CISPR 22): Class A emissions
- EN 55024 (CISPR 24): Immunity
- AS/NZS CISPR 11: Group 1, Class A emissions
- AS/NZS CISPR 22: Class A emissions
- FCC 47 CFR Part 15B: Class A emissions
- ICES-001: Class A emissions



Note In the United States (per FCC 47 CFR), Class A equipment is intended for use in commercial, light-industrial, and heavy-industrial locations. In Europe, Canada, Australia and New Zealand (per CISPR 11) Class A equipment is intended for use only in heavy-industrial locations.



Note Group 1 equipment (per CISPR 11) is any industrial, scientific, or medical equipment that does not intentionally generate radio frequency energy for the treatment of material or inspection/analysis purposes.



Note For EMC declarations and certifications, and additional information, refer to the [Online Product Certification](#) section.

CE Compliance

This product meets the essential requirements of applicable European Directives, as follows:

- 2014/35/EU; Low-Voltage Directive (safety)
- 2014/30/EU; Electromagnetic Compatibility Directive (EMC)
- 2014/34/EU; Potentially Explosive Atmospheres (ATEX)

Online Product Certification

Refer to the product Declaration of Conformity (DoC) for additional regulatory compliance information. To obtain product certifications and the DoC for this product, visit ni.com/certification, search by model number or product line, and click the appropriate link in the Certification column.

Shock and Vibration

To meet these specifications, you must panel mount the system.

Operating vibration	
Random (IEC 60068-2-64)	5 g _{rms} , 10 Hz to 500 Hz
Sinusoidal (IEC 60068-2-6)	5 g, 10 Hz to 500 Hz
Operating shock (IEC 60068-2-27)	30 g, 11 ms half sine; 50 g, 3 ms half sine; 18 shocks at 6 orientations

Environmental

Refer to the manual for the chassis you are using for more information about meeting these specifications.

Operating temperature (IEC 60068-2-1, IEC 60068-2-2)	-40 °C to 70 °C
Storage temperature (IEC 60068-2-1, IEC 60068-2-2)	-40 °C to 85 °C
Ingress protection	IP40
Operating humidity (IEC 60068-2-78)	10% RH to 90% RH, noncondensing
Storage humidity (IEC 60068-2-78)	5% RH to 95% RH, noncondensing
Pollution Degree	2
Maximum altitude	5,000 m

Indoor use only.

Environmental Management

NI is committed to designing and manufacturing products in an environmentally responsible manner. NI recognizes that eliminating certain hazardous substances from our products is beneficial to the environment and to NI customers.

For additional environmental information, refer to the *Minimize Our Environmental Impact* web page at ni.com/environment. This page contains the environmental regulations and directives with which NI complies, as well as other environmental information not included in this document.

Waste Electrical and Electronic Equipment (WEEE)



EU Customers At the end of the product life cycle, all NI products must be disposed of according to local laws and regulations. For more information about how to recycle NI products in your region, visit ni.com/environment/weee.

电子信息产品污染控制管理办法（中国 RoHS）



中国客户 National Instruments 符合中国电子信息产品中限制使用某些有害物质指令 (RoHS)。关于 National Instruments 中国 RoHS 合规性信息，请登录 ni.com/environment/rohs_china。(For information about China RoHS compliance, go to ni.com/environment/rohs_china.)

Calibration

You can obtain the calibration certificate and information about calibration services for the NI 9232 at ni.com/calibration.

Calibration interval	1 year
----------------------	--------

Refer to the *NI Trademarks and Logo Guidelines* at ni.com/trademarks for information on NI trademarks. Other product and company names mentioned herein are trademarks or trade names of their respective companies. For patents covering NI products/technology, refer to the appropriate location: **Help»Patents** in your software, the `patents.txt` file on your media, or the *National Instruments Patent Notice* at ni.com/patents. You can find information about end-user license agreements (EULAs) and third-party legal notices in the readme file for your NI product. Refer to the *Export Compliance Information* at ni.com/legal/export-compliance for the NI global trade compliance policy and how to obtain relevant HTS codes, ECCNs, and other import/export data. NI MAKES NO EXPRESS OR IMPLIED WARRANTIES AS TO THE ACCURACY OF THE INFORMATION CONTAINED HEREIN AND SHALL NOT BE LIABLE FOR ANY ERRORS. U.S. Government Customers: The data contained in this manual was developed at private expense and is subject to the applicable limited rights and restricted data rights as set forth in FAR 52.227-14, DFAR 252.227-7014, and DFAR 252.227-7015.

© 2015 National Instruments. All rights reserved.

373932A-02 Dec15