



# InAs and GaAs Hall Sensors

## Hall sensor theory

A Hall sensor is a solid state sensor which provides an output voltage proportional to magnetic flux density. As implied by its name, this device relies on the Hall effect. The Hall effect is the development of a voltage across a sheet of conductor when current is flowing and the conductor is placed in a magnetic field.

Electrons (the majority carrier most often used in practice) “drift” in the conductor when under the influence of an externally produced electric field. These moving electrons experience a force proportional and perpendicular to the product of their velocity and the magnetic field vector. This force causes the charging of the edges of the conductor, one side positive with respect to the other, resulting in an internally generated transverse electric field which exerts a force on the moving electrons equal and opposite to that caused by the magnetic-field-related Lorentz force. The resultant voltage potential across the width of the conductor is called the Hall voltage and can be measured by attaching two electrical contacts to the sides of the conductor.

The Hall voltage can be given by the expression:

$$V_H = Y_B B \sin \theta$$

where  $V_H$  = Hall voltage (mV)

$Y_B$  = Magnetic sensitivity  
(mV per kG, at a fixed current)

$B$  = Magnetic field flux density (kG)

$\theta$  = Angle between magnetic flux vector and the plane of Hall sensor

As can be seen from the above formula, the Hall voltage varies with the angle of the sensed magnetic field, reaching a maximum when the field is perpendicular to the plane of the Hall sensor.

### A typical Hall effect measurement scheme

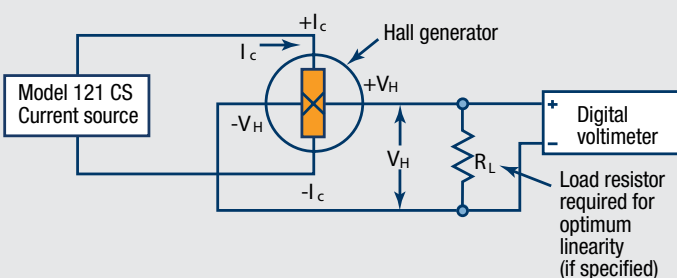

**CAUTION:** These sensors are sensitive to electrostatic discharge (ESD). Use ESD precautionary procedures when handling, or making mechanical or electrical connections to these devices in order to avoid performance degradation or loss of functionality.

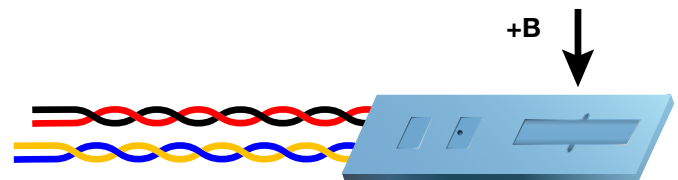

Transverse

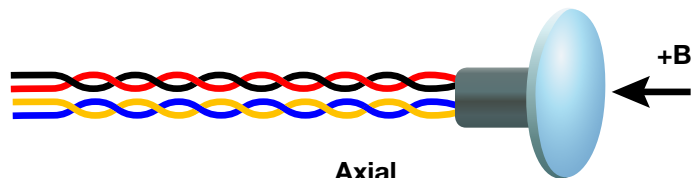

Axial

**Hall sensors come in axial and transverse configurations.**

**Transverse** devices are generally thin and rectangular in shape. They are applied successfully in magnetic circuit gaps, surface measurements, and general open field measurements.

**Axial** sensors are mostly cylindrical in shape. Their applications include ring magnet center bore measurements, solenoids, surface field detection, and general field sensing. See the individual Hall sensor illustrations for physical dimensions.

### Active area

The Hall sensor assembly contains the sheet of semiconductor material to which the four contacts are made. This entity is normally called a “Hall plate.” The Hall plate is, in its simplest form, a rectangular shape of fixed length, width and thickness. Due to the shorting effect of the current supply contacts, most of the sensitivity to magnetic fields is contained in an area approximated by a circle, centered in the Hall plate, whose diameter is equal to the plate width. Thus, when the active area is given, the circle as described above is the common estimation.



## Using a Hall sensor

A Hall sensor is a 4-lead device. The control current ( $I_c$ ) leads are normally attached to a current source such as the Lake Shore Model 121. The Model 121 provides several fixed current values compatible with various Hall sensors.

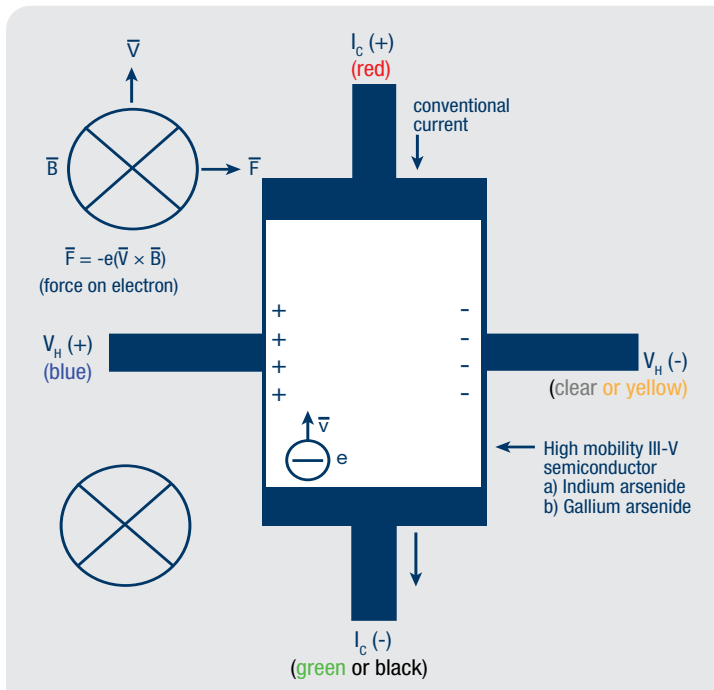

**Caution:** Do not exceed the maximum continuous control current given in the specifications.

The Hall voltage leads may be connected directly to a readout instrument, such as a high impedance voltmeter, or can be attached to electronic circuitry for amplification or conditioning. Device signal levels will be in the range of microvolts to hundreds of millivolts.

The Hall sensor input is not isolated from its output. In fact, impedance levels on the order of the input resistance are all that generally exist between the two ports. To prevent erroneous current paths, which can cause large error voltages, the current supply must be isolated from the output display or the down stream electronics.

## Ordering information

Part number	Description
HMCBL-6	1.8 m (6 ft) long cable for Model 475 and 455
HMCBL-20	6.1 m (20 ft) long cable for Model 475 and 455

All specifications are subject to change without notice

## Attaching discrete Hall sensors to Lake Shore gaussmeters

Lake Shore provides cable assemblies containing the electronic memory (EEPROM) to interface a Hall sensor to a gaussmeter. This allows users to assemble a Hall sensor into a difficult to access area prior to gaussmeter attachment. The figure below shows the general cable configuration. While convenient, this method provides less than optimum performance. Because of the intricacies involved with proper calibration, the user is responsible for the measurement accuracy. A probe fully calibrated by Lake Shore is always suggested. Special probe mechanical configurations are also available.

Certain Hall sensor sensitivity constraints are applicable:

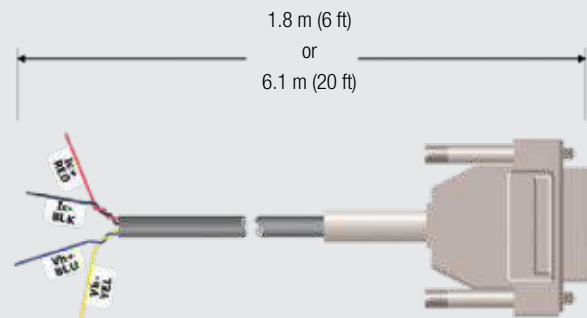

Sensitivities between 5.5 and 10.5 mV/kG at 100 mA control current.

Sensitivities between 0.55 and 1.05 mV/kG at 100 mA control current.

### For the Model 475, 455, and 425 gaussmeters

2 m (6 ft) and 6.1 m (20 ft) cables are available.

The 475, 455, and 425 gaussmeters offer the convenience of front panel programming. No external computer is required. The Hall sensor serial number and single-point sensitivity are directly entered using the keypad.

### For the Model 460, 450, and 421 gaussmeters

Connection of discrete Hall sensors to these instruments is no longer supported. Contact Service for ongoing support of these instruments.



## Axial Hall sensors

## Lead colors:

Red	+I <sub>C</sub>
Green	-I <sub>C</sub>
Blue	+V <sub>H</sub>
Clear	-V <sub>H</sub>

## HGA-2303

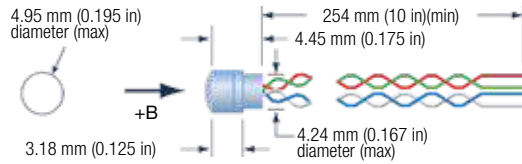

## HGA-2302

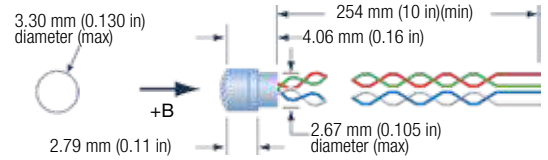

## HGA-2010

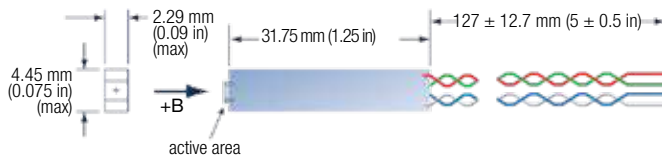

## HGA-3010\*, HGA-3030\*

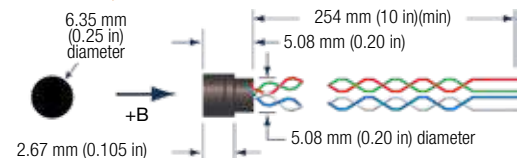

\*The active area is symmetrical with the center line of the assembly and is located approximately 0.030 in behind the front surface of the assembly

	HGA-2010†	HGA-2302	HGA-2303	HGA-3010	HGA-3030
Description	General purpose axial; high sensitivity	General purpose axial; 3.30 mm (0.13 in) diameter	General purpose axial; 4.95 mm (0.195 in) diameter	Instrumentation quality axial; low temperature coefficient; phenolic package	Instrumentation quality axial; phenolic package
RoHS	No	No	No	Yes	Yes
Active area (approx)	0.127 × 0.127 mm (0.005 in × 0.005 in) square	0.51 × 1.02 mm (0.020 × 0.040 in) rectangle	0.51 × 1.02 mm (0.020 × 0.040 in) rectangle	0.76 mm (0.030 in) diameter circle	0.76 mm (0.030 in) diameter circle
Input resistance (approx)	450 Ω to 900 Ω	2 Ω	2 Ω	1 Ω	2 Ω
Output resistance (approx)	550 Ω to 1350 Ω	2 Ω	2 Ω	1 Ω	2 Ω
Nominal control current (I <sub>CN</sub> )	1 mA	100 mA			
Maximum continuous current (non-heat sinked, 25 °C)	10 mA	150 mA	200 mA	300 mA	
Magnetic sensitivity†† (I <sub>C</sub> = nominal control current)	11 mV/kG to 28 mV/kG	5.5 mV/kG to 11.0 mV/kG	5.5 mV/kG to 11.0 mV/kG	0.55 mV/kG to 1.05 mV/kG	6.0 mV/kG to 10.0 mV/kG
Maximum linearity error (sensitivity vs. field, % rdg)	±1 (-10 kG to +10 kG) ±2 (-20 kG to +20 kG)	±1 (-10 kG to +10 kG)		±1 (-30 kG to +30 kG) ±1.5 (-100 kG to +100 kG)	±0.30 (-10 kG to +10 kG) ±1.25 (-30 kG to +30 kG)
Zero field offset voltage (I <sub>C</sub> = nominal control current)	±2.8 mV (max)	±100 μV (max)		±50 μV (max)	±75 μV (max)
Operating temperature range	-40 °C to +100 °C				
Temperature coefficient of magnetic sensitivity	-0.06%/°C (max)	-0.08%/°C (max)		-0.005%/°C (max)	-0.04%/°C (max)
Temperature coefficient of offset (I <sub>C</sub> = nominal control current)	±6 μV/°C (approx)	±1 μV/°C (approx)		±0.4 μV/°C (approx)	±0.3 μV/°C (approx)
Temperature coefficient of resistance	+0.3%/°C (approx)	+0.18%/°C (approx)	+0.18%/°C (approx)	+0.15%/°C (approx)	+0.18%/°C (approx)
Leads	34 AWG copper with poly-nylon insulation	36 AWG copper with poly-nylon insulation	34 AWG copper with poly-nylon insulation	34 AWG copper with poly-nylon insulation	34 AWG copper with poly-nylon insulation
Data	Single sensitivity value at I <sub>C</sub> = 1 mA	Single sensitivity value at I <sub>C</sub> = 100 mA	Single sensitivity value at I <sub>C</sub> = 100 mA	Room temperature, 30 kG data supplied	

† Not compatible with Lake Shore gaussmeters

†† Sensitivity nominal control current without a linearizing resistor. A linearizing resistor may be required to achieve specified linearity, resulting in slightly reduced sensitivity. See Chapter 4.3 of the Hall sensor manual for more details.

## Ordering information

## Part number Description

HGA-2010	General purpose axial Hall sensor; plastic package
HGA-2302	General purpose axial Hall sensor; phenolic shoulder
HGA-2303	General purpose axial Hall sensor; phenolic shoulder
HGA-3010	Instrumentation quality axial Hall sensor; phenolic package
HGA-3030	Instrumentation quality axial Hall sensor; phenolic package

## Accessories available

CAL-1X-DATA	1-axis Hall sensor recalibration with certificate and data
-------------	--

All specifications are subject to change without notice



## Transverse Hall sensors

## Lead Colors

Red	+I <sub>C</sub>
Green	-I <sub>C</sub>
Blue	+V <sub>H</sub>
Clear	-V <sub>H</sub>

## HGT-1010

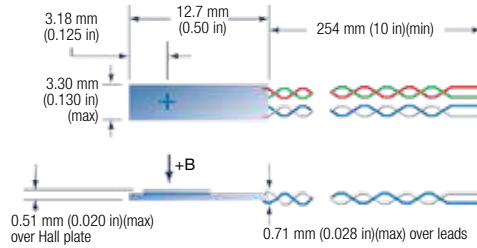

## HGT-1020

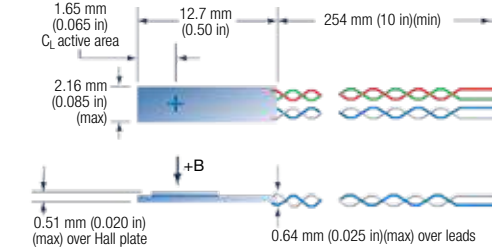

## HGT-2101

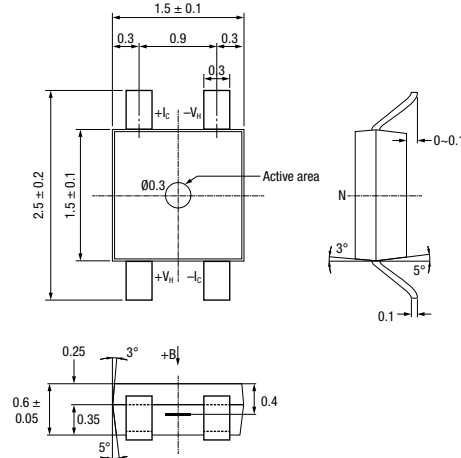

## HGT-2010

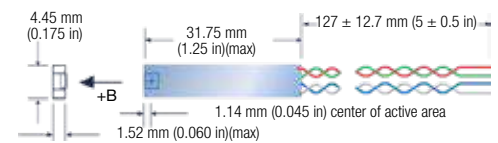

## HGT-3010, HGT-3030

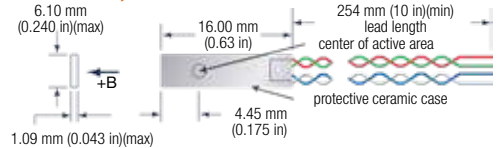

	HGT-1010	HGT-1020	HGT-2010*	HGT-2101*	HGT-3010	HGT-3030
Description	General purpose transverse		General purpose transverse; high sensitivity	Low cost; high sensitivity; surface mount	Instrumentation quality transverse; low temp coefficient; ceramic package	Instrumentation quality transverse ceramic package
✓RoHS	No	No	No	Yes	Yes	Yes
Active area (approx)	1.02 mm (0.040 in) diameter circle	0.76 mm (0.030 in) diameter circle	0.127 mm (0.005 in) square	0.3 mm (0.012 in) diameter circle	1.02 mm (0.040 in) diameter circle	
Input resistance (approx)	2 Ω		450 Ω to 900 Ω		1 Ω	2 Ω
Output resistance (approx)	2 Ω		550 Ω to 1350 Ω		1 Ω	2 Ω
Nominal control current (I <sub>CN</sub> )	100 mA		1 mA		100 mA	
Maximum continuous current (non-heat sunked, 25 °C)	250 mA	200 mA	10 mA		300 mA	
Magnetic sensitivity (I <sub>C</sub> = nominal control current)	7.5 mV/kG to 12.5 mV/kG		11 mV/kG to 28 mV/kG		0.55 mV/kG to 1.05 mV/kG	6.0 mV/kG to 10.0 mV/kG
Maximum linearity error (sensitivity versus field)	±1.0% rdg (-10 to 10 kG)		±1% rdg (-10 to 10 kG) ±2% rdg (-20 to 20 kG)	±2.0% rdg (-10 to 10 kG)	±1% rdg (-30 to 30 kG) ±1.5% rdg (-100 to 100 kG)	±0.30% rdg (-10 to 10 kG) ±1.25% rdg (-30 to 30 kG)
Zero field offset voltage (I <sub>C</sub> = nominal control current)	±100 μV (max)		±2.8 mV (max)		±50 μV (max)	±75 μV (max)
Operating temperature range	-40 °C to +100 °C		-40 °C to +125 °C		-40 °C to +100 °C	
Temperature coefficient of magnetic sensitivity	-0.08%/°C (max)		-0.06%/°C (max)		-0.005%/°C max	-0.04%/°C (max)
Temperature coefficient of offset (I <sub>C</sub> = nominal control current)	±1 μV/°C (approx)		±6 μV/°C (approx)		±0.4 μV/°C (approx)	±0.3 μV/°C (approx)
Temperature coefficient of resistance	+0.18%/°C (approx)		+0.3%/°C (approx)		+0.15%/°C (approx)	+0.18%/°C (approx)
Leads	34 AWG copper with poly-nylon insulation	36 AWG copper with poly-nylon insulation	34 AWG copper with poly-nylon insulation	NA	34 AWG copper with poly-nylon insulation	
Data	Single sensitivity value at I <sub>C</sub> = 100 mA		Single sensitivity value at I <sub>C</sub> = 1 mA	Uncalibrated	Room temperature, 30 kG data supplied	

\*Not compatible with Lake Shore gaussmeters



## Cryogenic Hall sensors

## Lead Colors:

Red	+I <sub>C</sub>
Black	-I <sub>C</sub>
Blue	+V <sub>H</sub>
Yellow	-V <sub>H</sub>

## HGCA-3020

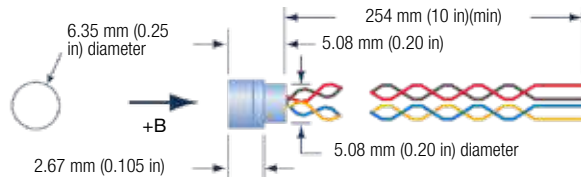

\*The active area is symmetrical with the center line of the assembly and is located 0.9 mm (0.035 in) ± 0.3 mm (0.012 in) behind the front surface of the assembly

	HGCA-3020	HGCT-3020
Description	Cryogenic axial; phenolic package	Cryogenic transverse; ceramic package
✓RoHS	No	
Active area (approx)	0.76 mm (0.030 in) diameter circle	1.02 mm (0.040 in) diameter circle
Input resistance (approx)	1 Ω	
Output resistance (approx)	1 Ω	
Nominal control current (I <sub>CN</sub> )	100 mA	
Maximum continuous current (non-heat sunked, 25 °C)	300 mA	
Magnetic sensitivity (I <sub>C</sub> = nominal control current)	0.55 mV/kG to 1.05 mV/kG	
Maximum linearity error (sensitivity vs field)	±1.0% rdg (-30 kG to +30 kG) ±2.0% rdg (-150 kG to +150 kG)	
Zero field offset voltage (I <sub>C</sub> = nominal control current)	±200 μV (max)	
Operating temperature range	1.5 K to 375 K	
Mean temperature coefficient of magnetic sensitivity	see temperature error table below	
Mean temperature coefficient of offset (I <sub>C</sub> = nominal control current)	±0.4 μV/K (approx)	
Mean temperature coefficient of resistance	+0.6%/K (max)	
Leads	34 AWG copper with Teflon® insulation	
Data	Room temperature, 30 kG data supplied	

## Temperature error table

The magnetic sensitivity generally increases as the temperature drops below 300 K. However, this trend reverses between 200 K and 100 K, and the sensitivity decreases at an increasing rate as the temperature cools. The sensitivity increase versus room temperature is as follows:

Change in magnetic sensitivity (approximate)	
Room temperature	Ref
200 K	+0.05%
100 K	-0.04%
80 K	-0.09%
20 K	-0.4%
4 K	-0.7%
1.5 K	-1.05%

## HGCT-3020\*

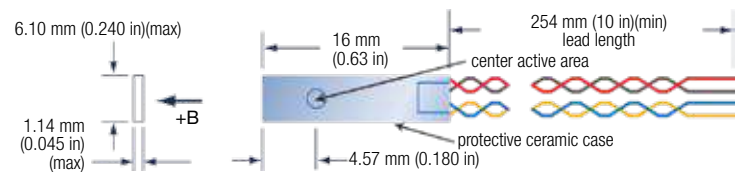

## Ordering information

## Axial Hall sensors

Part number	Description
HGA-2010	General purpose axial Hall sensor; plastic package
HGA-2302	General purpose axial Hall sensor; phenolic shoulder
HGA-2303	General purpose axial Hall sensor; phenolic shoulder
HGA-3010	Instrumentation quality axial Hall sensor; phenolic package
HGA-3030	Instrumentation quality axial Hall sensor; phenolic package

## Transverse Hall sensors

Part number	Description
HGT-1010	General purpose transverse Hall sensor
HGT-1020	General purpose transverse Hall sensor
HGT-2010	General purpose transverse Hall sensor
HGT-2101	Surface mount transverse Hall sensor
HGT-3010	Instrumentation quality transverse Hall sensor; ceramic package
HGT-3030	Instrumentation quality transverse Hall sensor; ceramic package

## Cryogenic Hall sensors

Part number	Description
HGCA-3020	Cryogenic axial Hall sensor; phenolic package
HGCT-3020	Cryogenic transverse Hall sensor; ceramic package

## Accessories available

CAL-1X-DATA	1-axis Hall sensor recalibration with certificate and data
-------------	--

All specifications are subject to change without notice