sbRIO-9603

Specifications

2024-08-23



Contents

sbRIO-9603 Specifications 3

sbRIO-9603 Specifications

sbRIO-9603 Features

The sbRIO-9603 is an embedded CompactRIO Single-Board Controller that integrates a real-time processor, a user-reconfigurable FPGA, and digital I/O on a single printed circuit board (PCB). You can embed the sbRIO-9603 in high-volume OEM applications that require flexibility, reliability, and high performance. This controller features two Gigabit Ethernet connectors, an RS-232 serial port, a CAN port, and a high-density RIO Mezzanine Card (RMC) connector that provides the option to connect two C Series I/O modules and 96 2.5 V/3.3 V single-ended digital I/O lines or 45 differential pairs.

- NI-DAQmx support for C Series modules and onboard I/O as well as I/O expansion using CompactDAQ or FieldDAQ
- TSN support on both Gigabit Ethernet ports
- LVDS support for 45 RMC DIO lines
- PCIe x1 Gen 2.0 and SATA Gen 2.0 over RMC

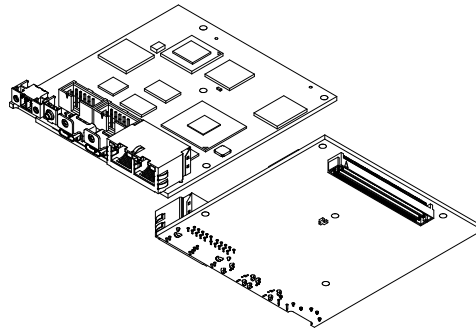

Figure 1. sbRIO-9603 Block Diagram

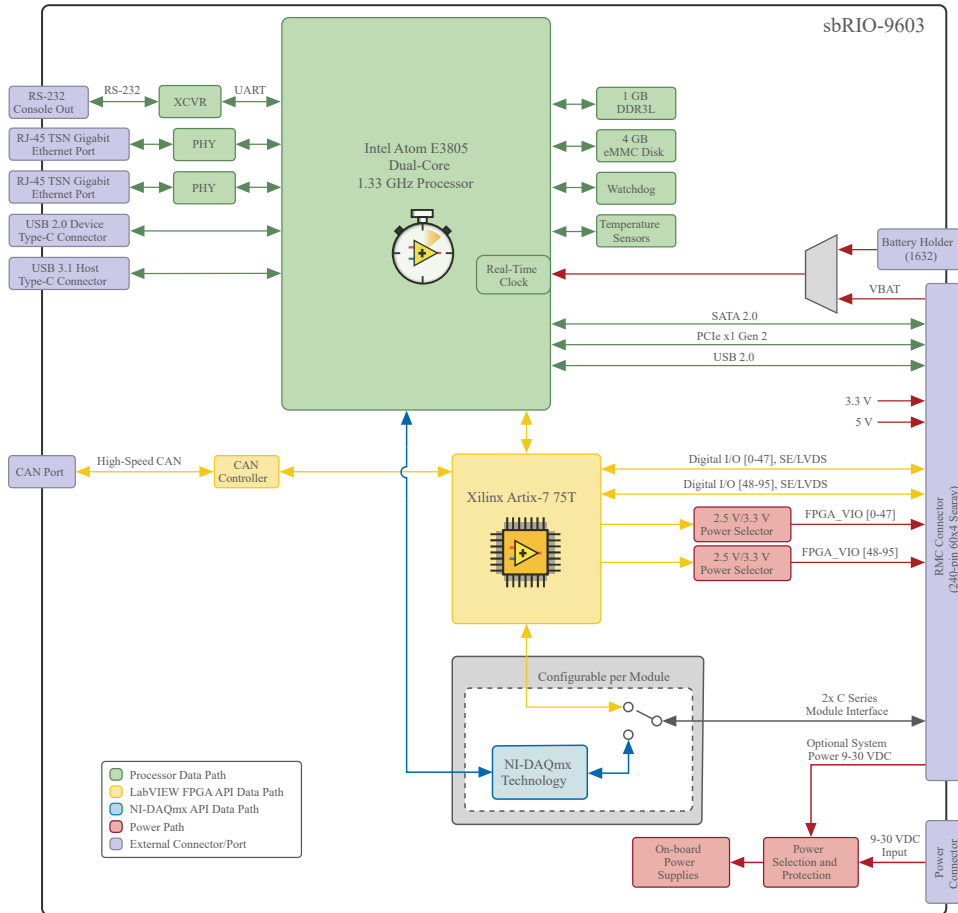

Table 1. CompactRIO Single Board Controller with DAQmx Model Comparison

Components	sbRIO-9603	sbRIO-9608	sbRIO-9609	sbRIO-9628	sbRIO-9629	s
Part Number						
Development Kit Part Number	787287-01	787288-01	787289-01	787296-01	787298-01	
OEM Kit Part Number	787287-02	787288-02	787289-02	787296-02	787298-02	
Performance						
Processor	Intel E3805 1.33 GHz Dual-Core		Intel E3845 1.91 GHz Quad-Core	Intel E3825 1.33 GHz Dual-Core	Intel E3845 1.91 GHz Quad-Core	1.33
RAM (DDR3L)	1 GB		2 GB	1 GB	2GB	
Disk (eMMC)				4 GB		
Xilinx Artix-7	XC7A75T		XC7A200T	XC7A100T	XC7A200T	

Components	sbRIO-9603	sbRIO-9608	sbRIO-9609	sbRIO-9628	sbRIO-9629	s
FPGA						
Onboard Peripherals						
Ethernet	2x IEEE 802.1AS-2011IEEE 1588-2008 (default end-to-end profile)					
USB Type-C port	USB 2.0 device					
USB Type-C port	1x USB 3.1 Gen1 Host					
DisplayPort Alt Mode	No		Yes			
USB Type-A port	—			2x USB 2.0 host		
SD port	—			microSDHC		
CAN port	1x CAN FD					
RS-232 port	1x			2x		
RS-485 port	—			1x		
Onboard IO ¹						
Analog I/O	—			16 SE/8 Differential, 233 kS/s, 16-bit, ±10		
				4x AO 100 kS/s/ch, 16-bit, ±10 V		
Digital I/O (5 V tolerant)	—			4x DIO		
RMC Connector						
C Series	2x C Series interfaces ²					
USB	USB 2.0 host					
DIO	96x DIO ³ , 3.3 V/2.5 V SE/Differential					
PCIe	1x PCIe x1 Gen 2.0					
SATA	1x SATA Gen 2.0					

1. Programmable through LabVIEW FPGA and NI-DAQmx.
2. Programmable through LabVIEW FPGA and NI-DAQmx.
3. Programmable with LabVIEW FPGA only. Configurable as 4x RS-232 UARTs or 2x RS-485 UARTs via the sbRIO CLIP generator.

Components	sbRIO-9603	sbRIO-9608	sbRIO-9609	sbRIO-9628	sbRIO-9629	s
Power	Optional Input Power from RMC (9 V to 30 V), Output power to RMC (3.3 V and 5 V, FPGA VIO)					

Definitions

Warranted specifications describe the performance of a model under stated operating conditions and are covered by the model warranty.

Characteristics describe values that are relevant to the use of the model under stated operating conditions but are not covered by the model warranty.

- **Typical** specifications describe the performance met by a majority of models.
- **Nominal** specifications describe an attribute that is based on design, conformance testing, or supplemental testing.

Specifications are **Typical** unless otherwise noted.

Conditions

Specifications are valid for -40 °C to 85 °C unless otherwise noted.

Software



Note For minimum software support information, visit ni.com/r/swsupport.

Supported operating system	NI Linux Real-Time (64-bit)
Supported C Series module programming modes	Real-Time (NI-DAQmx) mode Real-Time Scan (I/O Variables) mode LabVIEW FPGA mode

Application software	
LabVIEW ⁴	LabVIEW 2019 or later, LabVIEW Real-Time Module 2019 or later, LabVIEW FPGA Module 2019 or later
Driver software	NI CompactRIO Device Drivers 19.5 or later
Planned Software Support	
Support for RS-232 through RMC connector	NI CompactRIO Device Drivers 19.6 or later
Support for RS-485 through RMC connector	NI CompactRIO Device Drivers 19.6 or later
Support for CAN and CAN FD through dedicated CAN port	NI CompactRIO Device Drivers 20.5 or later

To set up a C/C++ based toolchain, visit ni.com/info and enter the info code `NILRTCrossCompile` for more information.

Processor

CPU	Intel Atom E3805
Number of cores	2

4. LabVIEW FPGA Module is not required when using Real-Time Scan (I/O Variables) mode or Real-Time (NI-DAQmx) mode. To program the user-accessible FPGA on the sbRIO-9603, the LabVIEW FPGA Module is required.

CPU frequency	1.33 GHz
On-die L2 cache	1 MB (shared)

Memory

Density	1 GB
Type	DDR3L
Maximum theoretical data rate	8.533 GB/s

Storage

Storage	4 GB
Storage type	Planar SLC NAND



Note Visit ni.com/r/ssdbp for information about the life span of the nonvolatile memory and about best practices for using nonvolatile memory.

Network/Ethernet Port

Number of ports	2
-----------------	---

Network interface	10Base-T, 100Base-TX, and 1000Base-T Ethernet
Compatibility	IEEE 802.3
Communication rates	10 Mb/s, 100 Mb/s, 1000 Mb/s auto-negotiated
Maximum cabling distance	100 m/segment

Network Timing and Synchronization

Protocol	IEEE 802.1AS-2011 IEEE 1588-2008 (default end-to-end profile)
Network synchronization accuracy ⁵	<1 μ s



Note The sbRIO-9603 employs time-aware transmission support. For more information about time-aware transmission support, visit ni.com/r/timeaware.

USB Ports

USB Type-C device port	
USB interface	USB 2.0, Hi-Speed

5. Network synchronization is system-dependent. For information about network synchronization accuracy, visit ni.com/r/crionsync.

Maximum data rate	480 Mb/s
Maximum current (from host)	250 mA
USB Type-C host port	
USB interface	USB 3.1 Gen1, SuperSpeed
Maximum data rate	5 Gb/s
Maximum current	900 mA

Internal Real-Time Clock

Accuracy	200 ppm; 40 ppm at 25 °C
----------	--------------------------

CMOS Battery

Onboard battery type	BR1632
Typical battery life	
Power applied to power connector	10 years
Stored at temperatures up to 25 °C	3.0 years
Stored at temperatures up to 85 °C	2.25 years

RS-232 (DTE) Serial Port

Number of interfaces	
Onboard RS-232	1 (ASRL1)
RMC RS-232 via FPGA	4
Baud rate support	Arbitrary
Maximum baud rate	921,600 b/s
Data bits	5, 6, 7, 8
Stop bits	1, 2
Parity	Odd, Even, Mark, Space
Flow control	RTS/CTS, XON/XOFF, DTR/DSR, None
Programming method	LabVIEW Real-Time (NI-VISA)

Reconfigurable FPGA

FPGA type	Xilinx Artix-7 XC7A75T
-----------	------------------------

Number of flip-flops	94,400
Number of 6-input LUTs	47,200
Number of DSP slices (18 × 25 multipliers)	180
Available block RAM	3,780 kbits
Number of DMA channels	16
Number of logical interrupts	32

CAN

Number of interfaces	1 (CAN0)
Programming Method	LabVIEW FPGA
Onboard CAN transceiver	TI TCAN4550
Maximum baud rate	
CAN	1 Mb/s
CAN FD	5 Mb/s

Digital I/O on RMC Connector

Number of DIO channels	96 single-ended, maximum 45 differential, maximum
Maximum tested current per channel	±3 mA



Note The performance of the RMC DIO pins is bounded by the FPGA, signal integrity, the application timing requirements, and the RMC design. A general SPI application will typically be able to meet these requirements and achieve frequencies of up to 10 MHz. For more information on using DIO to connect to RMCs, visit ni.com/r/RMCDIO.



Note Refer to the *Artix-7 FPGAs Data Sheet: DC and AC Switching Characteristics* document, *DS181*, for information about additional standards supported by the Artix-7 FPGA I/O.

Table 2. Single-Ended FPGA I/O Levels

I/O Standard	Input Voltage Low, V _{IL}		Input Voltage High, V _{IH}		Output Voltage Low, V _{OL} Maximum	Output Voltage High, V _{OH} Minimum	Drive Strength	FPGA_VIO
	Minimum	Maximum	Minimum	Maximum				
LVTTL	-0.3 V	0.8 V	2 V	3.45 V	0.4 V	2.4 V	4 mA, 8 mA, 12 mA, 16 mA, 24 mA	3.3 V
LVC MOS33								
LVC MOS25		0.7 V	1.7 V	FPGA_VIO + 0.30 V		FPGA_VIO - 0.40 V	4 mA, 8 mA, 12 mA, 16 mA	2.5 V

Table 3. Differential FPGA Input Levels

I/O Standard	Input Common Mode Voltage, V ICM			Input Differential Voltage, V ID			FPGA_VIO
	Minimum	Typical	Maximum	Minimum	Typical	Maximum	
LVDS_25	0.3 V	1.2 V	1.5 V	0.1 V	0.35 V	0.6 V	2.5 V
MINI_LVDS_25			1.71 V	0.2 V	0.4 V	0.6 V	

Table 4. Differential FPGA Output Levels⁶

I/O Standard	Output Common Mode Voltage, V OCM			Output Differential Voltage, V OD			FPGA_VIO
	Minimum	Typical	Maximum	Minimum	Typical	Maximum	
LVDS_25	1.0 V	1.25 V	1.425 V	0.247 V	0.35 V	0.6 V	2.5 V
MINI_LVDS_25	1.0 V	1.2 V	1.4 V	0.3 V	0.45 V	0.6 V ⁷	

Table 5. FPGA DIO Pins and Trace Lengths

Pins	Power Rail	Shortest Trace Length	Longest Trace Length	Length Matching Within Differential Pairs
DIO_47 ... DIO_0	FPGA_VIO<47..0>	12.7 mm (0.5 in.)	40.13 mm (1.58 in.)	0.25 mm (0.01 in.)
DIO_96 ... DIO_48	FPGA_VIO<96..48>	46.23 mm (1.82 in.)	71.88 mm (2.83 in.)	0.25 mm (0.01 in.)



Note One inch (1.0 in.) of trace creates approximately 167 ps of delay. Contact NI if your system requires tighter timing.

Additional RS-232 UART Support



Note Voltage levels are specified by the single-ended FPGA I/O levels in the *Digital I/O on RMC Connector* section.

6. $R_T = 100 \Omega$ across P and N pairs at destination

7. Internal VCCAUX = 1.8 V \pm 5%

Number of interfaces	4 (ASRL2, ASRL3, ASRL4, ASRL5)
Maximum baud rate	921,600 b/s
Data bits	5, 6, 7, 8
Stop bits	1, 2
Parity	Odd, Even, Mark, Space
Flow control	RTS/CTS, XON/XOFF, DTR/DSR, None

Additional RS-485 UART Support



Note Voltage levels are specified by the single-ended FPGA I/O levels in the *Digital I/O on RMC Connector* section.

Number of interfaces	2 (ASRL6, ASRL7)
Maximum baud rate	921,600 b/s
Data bits	5, 6, 7, 8
Stop bits	1, 2

Parity	Odd, Even, Mark, Space
Flow control	XON/XOFF
Transmission modes	2-wire, 2-wire auto, 4-wire

Power Outputs on RMC



Notice Exceeding the power limits may cause unpredictable device behavior.

+5 V power output (including 5 V C Series)	
Output voltage	5 V \pm 5%
Maximum current	1.5 A
Maximum ripple and noise	50 mV
+3.3 V_AUX power output	
Output voltage	3.3 V \pm 5%
Maximum current	0.33 A
Maximum ripple and noise	50 mV
FPGA_VIO (0 to 47) power output	

Output voltage	3.3 V \pm 5% or 2.5 V \pm 5%
Maximum current	0.33 A
Maximum ripple and noise	50 mV
FPGA_VIO (48 to 95) power output	
Output voltage	3.3 V \pm 5% or 2.5 V \pm 5%
Maximum current	0.33 A
Maximum ripple and noise	50 mV

Power Inputs on RMC



Notice Exceeding the power limits may cause unpredictable device behavior.



Note The onboard logic chooses the highest input voltage from the the built-in battery, V BAT on the RMC connector, and V IN through the power connector.

Voltage input range	9 V DC to 30 V DC
Reversed-voltage protection	30 V DC

Power consumption	28 W, maximum
V BAT power input	
Current consumption	2.5 μ A, nominal 6.75 μ A, maximum
Voltage level	3.3 V
Minimum voltage	2.3 V

Real-Time (NI-DAQmx) Mode

The following specifications are applicable for modules and slots programmed in Real-Time (NI-DAQmx) mode. For more information about using modules in LabVIEW FPGA mode or Real-Time Scan (I/O Variables) mode, visit ni.com/r/swsupport.

Analog Input

Input FIFO size	253 samples per slot
Maximum sample rate	Determined by the C Series module or modules
Timing accuracy	50 ppm of sample rate
Timing resolution	12.5 ns

Number of channels supported	Determined by the C Series module or modules
Number of hardware-timed tasks	8



Note Maximum sample rate performance is dependent on type of installed C Series module and number of channels in the task.



Note Timing accuracy does not include group delay. For more information, refer to the documentation for each C Series module.

Analog Output

Hardware-timed tasks	
Number of hardware-timed tasks	8
Number of channels supported	
Onboard regeneration	16
Non-regeneration	Determined by the C Series module or modules
Non-hardware-timed tasks	
Number of non-hardware-timed tasks	Determined by the C Series module or modules
Number of channels supported	Determined by the C Series module or modules
Maximum update rate	1.6 MS/s



Note Streaming applications are limited by system-dependent factors and the capability of C Series modules.

Timing accuracy	50 ppm of sample rate
Timing resolution	12.5 ns
Waveform onboard regeneration FIFO	8,191 samples shared among channels used
Waveform streaming FIFO	253 samples per slot

Digital Waveform

Waveform acquisition (DI) FIFO	
Parallel modules	255 samples per slot
Serial modules	127 samples per slot
Waveform onboard regeneration (DO) FIFO	
Parallel modules	2,047 samples shared among slots used
Waveform streaming (DO) FIFO	
Parallel modules	255 samples per slot
Serial modules	127 samples per slot
Sample clock frequency	

Digital input	0 MHz to 10 MHz
Digital output	
ot0:6 timing engine	0 MHz to 3.5 MHz
ot7 timing engine	0 MHz to 10 MHz



Note Streaming applications are limited by system-dependent factors and the capability of C Series modules.

Timing accuracy	50 ppm
Number of digital input hardware-timed tasks	8
Number of digital output hardware-timed tasks	8

General-Purpose Counters/Timers

Number of counters/timers	4
Resolution	32 bits
Counter measurements	Edge counting, pulse, semi-period, period, two-edge separation, pulse width

Position measurements	X1, X2, X4 quadrature encoding with Channel Z reloading; two-pulse encoding
Output applications	Pulse, pulse train with dynamic updates, frequency division, equivalent time sampling
Internal base clocks	80 MHz, 20 MHz, 13.1072 MHz, 12.8 MHz, 10 MHz, 100 kHz
External base clock frequency	0 MHz to 20 MHz
Base clock accuracy	50 ppm
Output frequency	0 MHz to 20 MHz
Inputs	Gate, Source, HW_Arm, Aux, A, B, Z, Up_Down
Routing options for inputs	Any module PFI, analog trigger, many internal signals
FIFO	Dedicated 127-sample FIFO

Frequency Generator

Number of channels	1
--------------------	---

Base clocks	20 MHz, 10 MHz, 100 kHz
Divisors	1 to 16 (integers)
Base clock accuracy	50 ppm
Output	Any module PFI terminal

Module PFI

Functionality	Static digital input, static digital output, timing input, and timing output
Timing output sources	Many analog input, analog output, counter, digital input, and digital output timing signals
Timing input frequency	0 MHz to 20 MHz
Timing output frequency	0 MHz to 20 MHz



Note Actual available timing output source signals are dependent on type of installed C Series module.

Digital Triggers

Source	Any module PFI terminal
Polarity	Software-selectable for most signals
Analog input function	Start Trigger, Reference Trigger, Pause Trigger, Sample Clock, Sample Clock Timebase
Analog output function	Start Trigger, Pause Trigger, Sample Clock, Sample Clock Timebase
Counter/timer function	Gate, Source, HW_Arm, Aux, A, B, Z, Up_Down

Module I/O States

At power-on	Module-dependent. Refer to the documentation for each C Series module.
-------------	--

Time-Based Triggers and Timestamps

Number of time-based triggers	5
Number of timestamps	6
Analog input	
Time-based triggers	Start Trigger, Sync Pulse

Timestamps	Start Trigger, Reference Trigger, First Sample
Analog output	
Time-based triggers	Start Trigger, Sync Pulse
Timestamps	Start Trigger, First Sample
Digital input	
Time-based triggers	Start Trigger
Timestamps	Start Trigger, Reference Trigger, First Sample
Digital output	
Time-based triggers	Start Trigger
Timestamps	Start Trigger, First Sample
Counter/timer input	
Time-based triggers	Arm Start Trigger
Timestamps	Arm Start Trigger
Counter/timer output	
Time-based triggers	Start Trigger, Arm Start Trigger

Timestamps	Start Trigger, Arm Start Trigger
------------	----------------------------------

RMC Support Signals

C Series	2 interfaces
PCIe	Gen 2.0
SATA	Gen 2.0
USB	
USB interface	USB 2.0 High-Speed Host
Maximum data rate	480 Mb/s

Table 6. Input Signals

Signal	V_{IL}		V_{IH}	
	Minimum	Maximum	Minimum	Maximum
SYS_RST#	-0.30 V	0.80 V	2.00 V	3.60 V
CLK_REQ				

Table 7. Output Signals

Signal	V_{OL} , Maximum	V_{OH} , Minimum	Maximum Sink Current	Maximum Source Current
FPGA_CONF	0.40 V	2.90 V	8.00 mA	8.00 mA
STATUS_LED				
RST#				

Signal	V _{OL} , Maximum	V _{OH} , Minimum	Maximum Sink Current	Maximum Source Current
USB_CPEN			4.00 mA	4.00 mA

Table 8. Signal Voltage Characteristics

Signal	Pull-Up Value, Typical	Rail Voltage
SYS_RST# ⁸	4.75 kΩ	3.3 V
CLK_REQ		

Power Requirements

The sbRIO-9603 requires a power supply connected either to the power connector or through the VIN_filtered pins through the RMC. Refer to the ***Connecting the sbRIO-96xx to Power*** section in the ***CompactRIO Single Board Controller with DAQmx Hardware Installation Manual*** on ni.com/manuals for information about connecting the power supply. Refer to the ***CompactRIO Single Board Controller with DAQmx System Development Manual*** on ni.com/manuals for more information about how to power the sbRIO-9603 through the RMC.



Notice Exceeding the power limits may cause unpredictable device behavior.

Recommended power supply	
Development kit	NI PS-10 Desktop Power Supply (included in kit)
	Condor STD-24050
	120 W, 24 V DC
OEM kit	55 W, 24 V DC, maximum

8. Pull-up on SYS_RST# is to 3.3 V when the model is in Run Mode, Safe Mode, and when in Sleep.

Voltage input range	9 V DC to 30 V DC	
Reversed-voltage protection	30 V DC	
Power consumption with RMC	55 W, maximum	
Replacement battery		
Manufacturer	Rayovac	
Model	BR1632	
Cell chemistry system	Lithium Carbon Monofluoride (Li/CF)	

Physical Characteristics

Weight	107 g (3.8 oz)
--------	----------------

sbRIO-9603 Dimensions

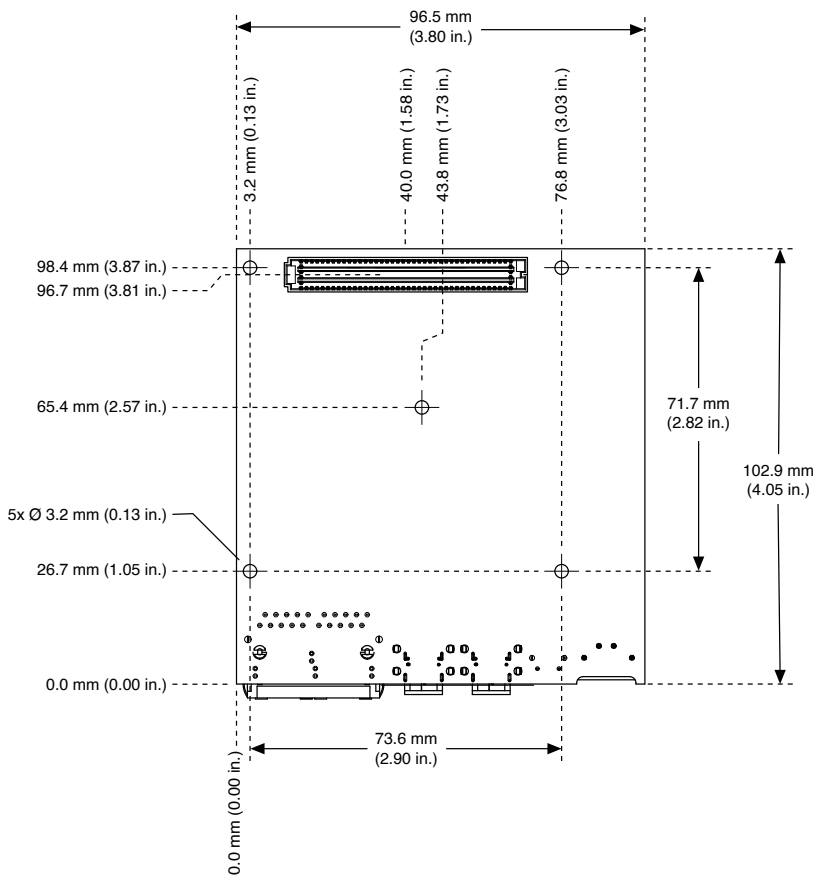

Safety Voltages

Connect only voltages that are below these limits.

V terminal to C terminal	30 V DC, maximum, Measurement Category I
--------------------------	--



Caution Do not connect the model to signals or use for measurements within Measurement Categories II, III, or IV.



Attention Ne connectez pas le modèle à des signaux et ne l'utilisez pas pour effectuer des mesures dans les catégories de mesure II, III ou IV.

Measurement Category I is for measurements performed on circuits not directly connected to the electrical distribution system referred to as **MAINS** voltage. MAINS is

a hazardous live electrical supply system that powers equipment. This category is for measurements of voltages from specially protected secondary circuits. Such voltage measurements include signal levels, special equipment, limited-energy parts of equipment, circuits powered by regulated low-voltage sources, and electronics.



Note Measurement Categories CAT I and CAT O are equivalent. These test and measurement circuits are for other circuits not intended for direct connection to the MAINS building installations of Measurement Categories CAT II, CAT III, or CAT IV.

Environmental Guidelines



Notice This model is intended for use in indoor applications only.



Notice The OEM Kit may require a heat sink or air flow to remain within the maximum allowed temperature ranges. You can mount the Thermal Kit for CompactRIO Single Board Controller with NI-DAQmx heat spreader on the NI sbRIO model.



Notice The Development Kit must be used with the Thermal Kit for CompactRIO Single Board Controller with NI-DAQmx.



Notice The model's thermal performance is greatly influenced by several factors, including resource utilization, mounting, and adjacent power dissipation. These factors can substantially affect the achievable external ambient temperature at which the maximum local and reported temperatures are reached. NI recommends you validate your system to ensure local and reported temperatures remain within maximum allowed temperature ranges. In some applications, additional thermal design may be necessary.



Notice Exercise caution when designing an enclosure for the model. Auxiliary cooling may be necessary to keep the model within the specified operating temperature range.

 **Notice** For information about and examples of environmental and design factors that can affect the thermal performance of NI sbRIO systems, visit ni.com/r/sbriocooling.

 **Notice** For model-specific guidelines about enabling proper thermal design, refer to the ***CompactRIO Single Board Controller with DAQmx Hardware Installation Manual*** on ni.com/manuals.

Local Ambient Temperature

Local ambient temperature is the temperature measured directly adjacent to the model.



Note Operating temperature refers to the temperature of the room, environment, or enclosure in which an sbRIO-9603 is installed. The maximum operating temperature allowable for sbRIO-9603 is determined by the monitored battery temperature. Refer to the device ***Safety, Environmental, and Regulatory Information*** document on ni.com/manuals for more information.



Note For more information about designing a thermal solution, validating temperature, and measuring both local ambient temperature and operating temperature, refer to the ***CompactRIO Single-Board Controller with NI-DAQmx Hardware Installation Manual*** on ni.com/manuals.

Environmental Characteristics

Local ambient temperature	-40 °C to 85 °C
Onboard sensor temperature	
CPU	108 °C, maximum ⁹

FPGA	98 °C, maximum
Primary System	85 °C, maximum
Secondary System	85 °C, maximum
Storage	-40 °C to 85 °C



Note NI recommends verifying the maximum case temperatures for the following components when designing a custom heat spreader. Refer to the ***CompactRIO Single Board Controller with DAQmx Hardware Installation Manual*** on ni.com/manuals for more information about validating the thermal characteristics of your system.

- The CPU reduces its operating frequency when the die temperature reaches 108 °C. NI recommends keeping the die temperature below 108 °C to guarantee optimal performance. Refer to the ***CompactRIO Single Board Controller with NI-DAQmx Hardware Installation Manual*** for information about monitoring the CPU die temperature.

Figure 2. sbRIO-9603 Component Locations

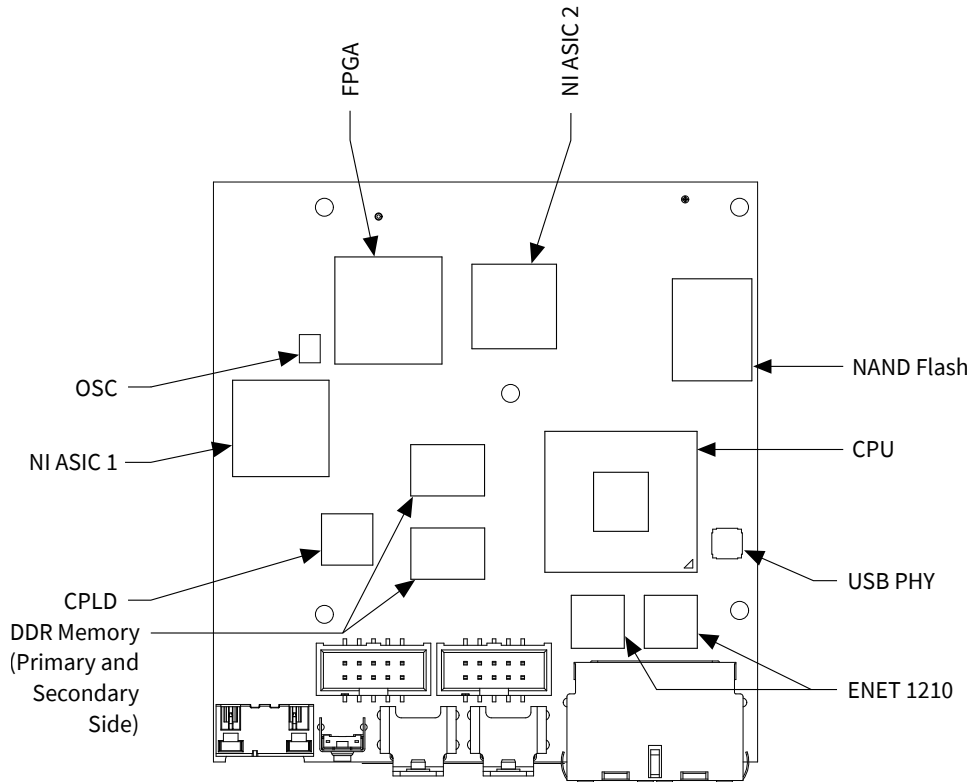

Table 9. Component Maximum Case Temperature

Component	Maximum Case Temperature
CPU	Validate digitally.
FPGA	Validate digitally.
CPLD	94 °C
NI ASIC 1	120 °C
NI ASIC 2	116 °C
DDR memory	95 °C
NAND Flash	91 °C
ENET I210	95 °C
USB PHY	120 °C
OSC	112 °C
Battery	85 °C

Humidity

Operating	10% RH to 90% RH, noncondensing	
Storage	5% RH to 95% RH, noncondensing	
Pollution Degree		2
Maximum altitude		5,000 m

Safety Compliance Standards

This product is designed to meet the requirements of the following electrical equipment safety standards for measurement, control, and laboratory use:

- IEC 61010-1, EN 61010-1
- UL 61010-1, CSA C22.2 No. 61010-1



Note For safety certifications, refer to the product label or the [Product Certifications and Declarations](#) section.

Electromagnetic Compatibility

This product meets the requirements of the following EMC standards for electrical equipment for measurement, control, and laboratory use:

- EN 61326-1 (IEC 61326-1): Class A emissions; Industrial immunity
- EN 55011 (CISPR 11): Group 1, Class A emissions
- AS/NZS CISPR 11: Group 1, Class A emissions
- FCC 47 CFR Part 15B: Class A emissions
- ICES-003: Class A emissions



Note In the United States (per FCC 47 CFR), Class A equipment is intended

for use in commercial, light-industrial, and heavy-industrial locations. In Europe, Canada, Australia and New Zealand (per CISPR 11) Class A equipment is intended for use in non-residential locations.



Note Group 1 equipment (per CISPR 11) is any industrial, scientific, or medical equipment that does not intentionally generate radio frequency energy for the treatment of material or inspection/analysis purposes.



Notice For EMC declarations and certifications, and additional information, refer to the [Product Certifications and Declarations](#) section.

Environmental Standards

This product meets the requirements of the following environmental standards for electrical equipment.

- IEC 60068-2-1 Cold
- IEC 60068-2-2 Dry heat

CE Compliance

This product meets the essential requirements of applicable European Directives, as follows:

- 2014/30/EU; Electromagnetic Compatibility Directive (EMC)
- 2011/65/EU; Restriction of Hazardous Substances (RoHS)

Product Certifications and Declarations

Refer to the product Declaration of Conformity (DoC) for additional regulatory compliance information. To obtain product certifications and the DoC for NI products, visit ni.com/product-certifications, search by model number, and click the appropriate link.

Environmental Management

NI is committed to designing and manufacturing products in an environmentally responsible manner. NI recognizes that eliminating certain hazardous substances from our products is beneficial to the environment and to NI customers.

For additional environmental information, refer to the ***Engineering a Healthy Planet*** web page at ni.com/environment. This page contains the environmental regulations and directives with which NI complies, as well as other environmental information not included in this document.

EU and UK Customers

-  **Waste Electrical and Electronic Equipment (WEEE)**—At the end of the product life cycle, all NI products must be disposed of according to local laws and regulations. For more information about how to recycle NI products in your region, visit ni.com/environment/weee.

Battery Replacement and Disposal

-  **Battery Directive**—This product contains a long-life coin cell battery. If you need to replace it, use the Return Material Authorization (RMA) process or contact an authorized NI service representative. For more information about compliance with the EU Battery Directive 2006/66/EC about Batteries and Accumulators and Waste Batteries and Accumulators, visit ni.com/environment/batterydirective.

Battery Recycling

The model contains a replaceable battery. Products containing lithium must be disposed of or recycled in accordance with all local laws and site regulations. For more information about disposing of or recycling this device's battery, refer to www.rayovac.com.

电子信息产品污染控制管理办法（中国RoHS）

-  **中国RoHS**—NI符合中国电子信息产品中限制使用某些有害物质指令 (RoHS)。关于NI中国RoHS合规性信息，请登录 ni.com/environment/rohs_china。(For information about China RoHS compliance, go to ni.com/)

environment/rohs_china.)

NI Services

Visit ni.com/support to find support resources including documentation, downloads, and troubleshooting and application development self-help such as tutorials and examples.

Visit ni.com/services to learn about NI service offerings such as calibration options, repair, and replacement.

Visit ni.com/register to register your NI product. Product registration facilitates technical support and ensures that you receive important information updates from NI.

NI corporate headquarters is located at 11500 N Mopac Expwy, Austin, TX, 78759-3504, USA.