

DC Electronic Loads

RMX-400x Series

USER MANUAL



ISO-9001 CERTIFIED MANUFACTURER



This manual contains proprietary information, which is protected by copyright. All rights are reserved. No part of this manual may be photocopied, reproduced or translated to another language without prior written consent of National Instruments Corporation.

The information in this manual was correct at the time of printing. However, National Instruments Corporation continues to improve products and reserves the right to change specification, equipment, and maintenance procedures at any time without notice.

© 2019-2024 National Instruments Corporation.

All rights reserved.

378075B-01 May 2024

Table of Contents

SAFETY INSTRUCTIONS	6
GETTING STARTED	12
Main Features.....	14
Series Overview	16
Package Contents and Accessories.....	18
Measurement Overview	20
Front Panel Overview	21
Display Overview – Mainframe.....	27
Rear Panel Overview.....	31
Front Panel Overview – Load Module.....	35
LED Display Overview – Load Module.....	39
Installation	42
Load Connections	49
Frame Link Connection.....	61
Channel Control Connection.....	63
Go/No Go Connection.....	67
OPERATING DESCRIPTION	68
Operating Mode Description	69
Group Unit Mode.....	80
Run Program	82
Sequence	85
OCP Test Automation.....	90
Parallel Dynamic Loading.....	91
Configurations Description.....	92
Interface and System.....	104
TUTORIALS	112
Local Loads	113



Single Channel Load	115
Parallel Load Modules	117
Programming	119
Sequences.....	121
Frame Link.....	122
Channel Control.....	124
General Configuration Options	126
OPERATION	127
Local Mode Operation	130
Mainframe Basic Operation.....	136
Creating a Program Sequence	165
Edit Sequence	179
OCP Test Automati on.....	189
Channel Configuration.....	196
Mainframe Configuration.....	225
Interface Configuration (Settings).....	251
RS232 and USB CDC Function Check	263
Socket Server Function Check	266
Saving/Recalling Channels	271
INTERFACE	311
Interface Configuration	312
FAQ	320
APPENDIX	321
Fuse Replacement.....	321
Firmware Update.....	322
Calibration	325
Range Chart	326
Default Settings.....	331
Specif icat ions	334
Dimensions	347



EC Declaration of Conformity..... 349

INDEX..... 350

S SAFETY INSTRUCTIONS

This chapter contains important safety instructions you must follow when operating the RMX-4000/4002, and when keeping it in storage. Read the following before operating the RMX-4000/4002 to ensure your safety and to keep the RMX-400x Series in the best possible condition.

Safety Symbols

These safety symbols may appear in this manual or on the RMX-4000/4002.



WARNING

Warning: Identifies conditions or practices that could result in injury or loss of life.



CAUTION

Caution: Identifies conditions or practices that could result in damage to the RMX-4000/4002 or to other properties.



DANGER High Voltage



Attention Refer to the Manual



Protective Conductor Terminal



Earth (ground) Terminal



Waste Electrical and Electronics Equipment (WEEE)

EU Customers At the end of the product life cycle, all NI products must be disposed of according to local laws and regulations. For more information about how to recycle NI products in your region, visit ni.com/environment/weee.

Safety Guidelines

General Guideline



CAUTION

- Do not place any heavy object on the RMX-4000/4002.
- Avoid severe impact or rough handling that leads to damaging the RMX-4000/4002.
- Do not discharge static electricity to the RMX-4000/4002.
- Do not block or obstruct the cooling fan vent openings.
- Do not perform measurement at circuits directly connected to Mains (Note below).
- Do not disassemble the RMX-4000/4002 unless you are qualified as service personnel.
- The equipment is not for measurements performed for CAT II, III and IV.

(Measurement categories) EN 61010-1:2010 specifies the measurement categories and their requirements as follows. The RMX-4000/4002 falls under category I.

- Measurement category IV is for measurement performed at the source of low-voltage installation.
 - Measurement category III is for measurement performed in the building installation.
 - Measurement category II is for measurement performed on the circuits directly connected to the low-voltage installation.
 - Measurement category I is for measurements performed on circuits not directly connected to Mains.
-

Power Supply



WARNING

- 100-120 Vac/ 200-240 Vac (90-132 Vac/ 180-250 Vac)
 Frequency: 47-63 Hz
 Power rating: RMX-4002: 250 VA Max
 RMX-4000: 150 VA Max
 - The power supply voltage should not fluctuate more than 15%.
 - Connect the protective grounding conductor of the AC power cord to an earth ground, to avoid electrical shock.
-

Fuse



WARNING

- Fuse type: T3.15 A/250 V
 - Make sure the correct type of fuse is installed before power up.
 - To avoid fire, replace the fuse with only the specified type and rating.
 - Disconnect the power cord before fuse replacement.
 - Make sure the cause of a fuse blowout is fixed before replacing the fuse.
-

- Cleaning the RMX-400x
- Disconnect the power cord before cleaning.
 - Use a soft cloth dampened in a solution of mild detergent and water. Do not spray any liquid.
 - Do not use chemicals or cleaners containing harsh material such as benzene, toluene, xylene, and acetone.
-

- Operation Environment
- Location: Indoor, no direct sunlight, dust free, almost non-conductive pollution (refer to the pollution degree descriptions below)
 - Temperature: 0 °C to 40 °C
 - Altitude: Up to 2000 m
 - Transient Overvoltage on the main supply is 2500 V.

(Pollution Degree) EN 61010-1:2010 specifies the pollution degrees and their requirements as follows. THE RMX-4000/4002 falls under degree 2.

Pollution refers to "addition of foreign matter, solid, liquid, or gaseous (ionized gases), that may produce a reduction of dielectric strength or surface resistivity".

- Pollution degree 1: No pollution or only dry, non-conductive pollution occurs. The pollution has no influence.
 - Pollution degree 2: Normally only non-conductive pollution occurs. Occasionally, however, a temporary conductivity caused by condensation must be expected.
 - Pollution degree 3: Conductive pollution occurs, or dry, non-conductive pollution occurs which becomes conductive due to condensation which is expected. In such conditions, equipment is normally protected against exposure to direct sunlight, precipitation, and full wind pressure, but neither temperature nor humidity is controlled.
-

- Storage environment
- Location: Indoor
 - Relative Humidity: < 80%
 - Temperature: -10 °C to 70 °C

Disposal

**Waste Electrical and Electronics Equipment (WEEE)**

EU Customers At the end of the product life cycle, all NI products must be disposed of according to local laws and regulations. For more information about how to recycle NI products in your region, visit ni.com/environment/weee.

Power Cord for the United Kingdom

When using the RMX-4000/4002 in the United Kingdom, make sure the power cord meets the following safety instructions.

NOTE: This lead/appliance must only be wired by competent persons.



WARNING: THIS APPLIANCE MUST BE EARTHED

IMPORTANT: The wires in this lead are colored in accordance with the following code:

Green/ Yellow:	Earth
Blue:	Neutral
Brown:	Live (Phase)



As the colors of the wires in main leads may not correspond with the colored marking identified in your plug/appliance, proceed as follows: The wire which is colored Green and Yellow must be connected to the Earth terminal marked with either the letter E, the earth symbol \oplus or colored Green/Green and Yellow.

The wire which is colored Blue must be connected to the terminal which is marked with the letter N or colored Blue or Black.

The wire which is colored Brown must be connected to the terminal marked with the letter L or P or colored Brown or Red.

If in doubt, consult the instructions provided with the equipment or contact the supplier.

This cable/appliance should be protected by a suitably rated and approved HBC mains fuse: refer to the rating information about the equipment and/or user instructions for details. As a guide, a cable of 0.75 mm² should be protected by a 3 A or 5 A fuse. Larger conductors would normally require 13 A types, depending on the connection method used.

Any exposed wiring from a cable, plug or connection that is engaged in a live socket is extremely hazardous. If a cable or plug is deemed hazardous, turn off the mains power and remove the cable, any fuses and fuse assemblies. All hazardous wiring must be immediately destroyed and replaced in accordance to the above standard.

GETTING STARTED

This chapter describes the features and functions of the RMX-4000/4002, including the front and rear panel appearance, panel installation and connection types. Use the Tutorial section for quick access to step-by-step instructions on the main functions.



Main Features.....	14
Series Overview	16
Package Contents and Accessories	18
Measurement Overview	20
Front Panel Overview	21
Display Overview – Mainframe.....	27
Rear Panel Overview	31
Front Panel Overview – Load Module	35
LED Display Overview – Load Module.....	39
Installation.....	42
Load Module Installation	42



Rack Mount Installation.....	45
Channel Number.....	46
Power Up and Self Test.....	47
Load Connections.....	49
Precautions and Procedures.....	49
Remote (Sense) Connection.....	54
Single-Load Connections.....	55
Parallel Load Connections.....	58
Frame Link Connection.....	61
Channel Control Connection.....	63
Go/NoGo Connection.....	67

Main Features

Description	<p>The RMX-4000 and 4002 are multichannel programmable DC electronic load mainframes. The RMX-4000 mainframe can hold two load modules, while the RMX-4002 can hold four. The flexible module configuration allows the mainframes to either sink multiple loads independently or large loads when used in parallel.</p> <p>The RMX-400x Series supports four operation modes: constant current (CC), constant voltage (CV and CV+CC), constant resistance (CR) and constant power (CP). Constant current and constant resistance mode can operate in either static or dynamic mode.</p>
-------------	---

- Feature Overview
- Flexible operation with removable load modules
 - Multiple independent isolated channels
 - High performance, up to 5-digit resolution
 - High slew rate enabling a high response speed
 - High capacity when frame linked
 - You can use different load module types in the same mainframe
 - Dedicated parallel mode
 - Supports rack mount installation (RMX-4002)
 - Supports frame link connections, with up to four slave units
 - Color LCD display
 - 120 different sets of programmable sequences
 - Accurate load simulation using sequences
 - Four panel setups
 - USB flash drive support
-

- Interface
- USB
 - RS-232C
 - LAN
-

Series Overview

The RMX-400x Series comprises of two different mainframes: the RMX-4000 and the RMX-4002. The mainframes differ by the number of load modules that can be accommodated. The RMX-4000 has two load module slots, while the RMX-4002 has four. There are four different load module models, the RMX-4003, RMX-4004, RMX-4005, and RMX-4006.

RMX-4002 Mainframe

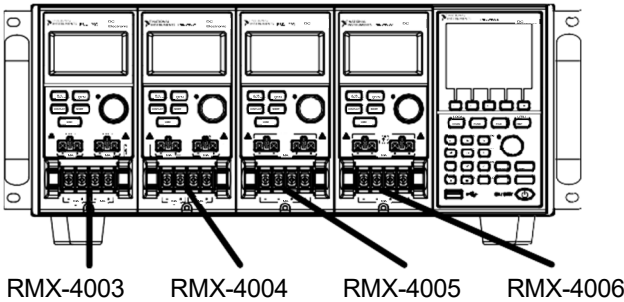

RMX-4000 Mainframe

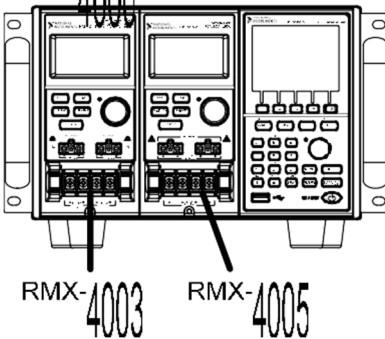

The four different load module models each differ in the amount of current, voltage and power and the number of channels that the load module can accommodate. The procedures in this manual will be load module model independent unless specifically stated. Below is a table

showing the basic differences between each load module model. For detailed specifications, refer to page 334.

Load Module	Channels	Power (W) CH L/R (Low/High Range)	Current (A) Range Low/High	Voltage (V)
RMX-4003 (100 W x 2)	2	100/100	2/20	0-80
RMX-4004 (30/(25/250 W))	2	30/(25/250)	5/4/40	0-80
RMX-4005	1	(35/350)	7/70	0-80
RMX-4006	1	(35/350)	1/10	0-500

Package Contents and Accessories

The RMX-400x electronic load has a number of standard and optional accessories. For more information, visit the National Instruments website at ni.com or consult your authorized distributor for details.

Standard Accessories	Description
Power Cable	Mains power cable (region dependent) (18 AWGx3C, 125 V/10 A, 1.8 m)
CD ROM	Contains RMX-400x Series User Manual, Programming Manual, and USB Driver
Load Cables	2X red, 2X black (per load module)
Sense Cables	1X red, 1X black (per load channel)

Options	Description
RMX-4003	Load Module
RMX-4004	
RMX-4005	
RMX-4006	

Optional Accessories	Description
786533-01	RMX-400x Rack Mount kit (handle only)
182238-01	RS-232C Cable (9F-9F serial cable, 1m)
182238-02	RS-232C Cable (9F-9F serial cable, 2m)
182238-04	RS-232C Cable (9F-9F serial cable, 4m)
184125-01	USB 2.0 Cable (Type A to Type B, 1m)
184125-02	USB 2.0 Cable (Type A to Type B, 2m)



GTL-249 Frame link cable

Measurement Overview

The RMX-400x Series has several operating modes that are completely configurable. All the modes have customizable Go/NoGo limits, range limits, timers, slew rates, alarms, and protection limits. For parallel loads, there is a dedicated parallel configuration mode. You can create programs and sequences to create tests.

Function	Description
Constant Current Mode (CC)	In constant current mode, the load module sinks a constant amount of current, regardless of the voltage.
Constant Voltage Mode (CV)	Under constant voltage mode, the voltage remains unchanged, regardless of the current.
Constant Resistance Mode (CR)	In constant resistance mode, the resistance load will remain unchanged as the voltage and current remain proportional.
Constant Power Mode (CP)	In constant power mode, the load module ensures the power consumed is constant.
Programmable Sequences (Prog.)	The load module supports programming sequences with up to 120 memory settings in 12 programs with 10 sequences.
Sequences (Seq.)	Use sequences to create load profiles to accurately simulate a load. You can create sequences for each channel.
Group Unit Mode	Group Unit Mode enables the RMX-400x mainframes to use load modules (of the same type/rating) easily in parallel. Use parallel mode in conjunction with CC or CR modes. You cannot use CP and CV mode with this mode.

Front Panel Overview

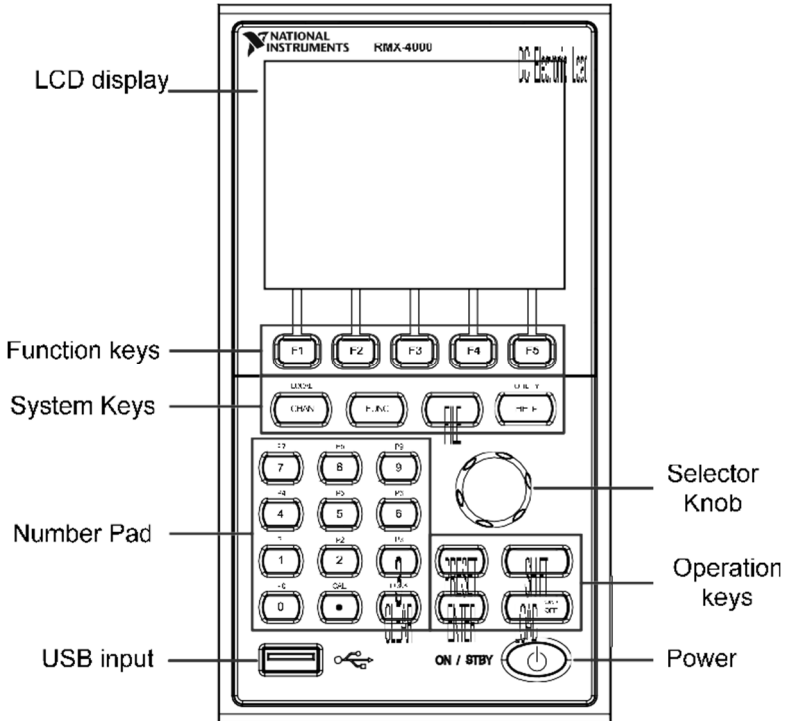

LCD display 320 by 240, TFT LCD display.

Function keys  ~  Access the menu functions on the bottom of the display.

System keys

LOCAL
 Use CHAN/LOCAL to select the load channel. Use LOCAL combined with the shift key to activate/deactivate local control (during remote control via the interface or frame link connections).

LOCAL
 Brings up the Channel Menu.

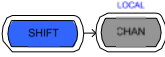
LOCAL
 Activates local control mode during remote control via the interface.

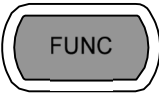
FUNC
 Accesses the Program, Sequence, or OCP automation menu.

FILE
 Accesses the File menu.

UTILITY
 Brings up the Help menu and utility menu.

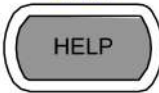
UTILITY
 Accesses help for the last function /key pressed.

UTILITY
 Activates the Utility Menu.

Number pad

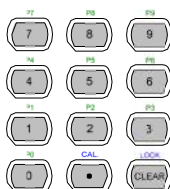

Enters numerical values or save/recall presets (P0-P9).

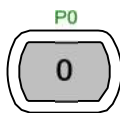

Number values.



Presets numbers P0-P9.

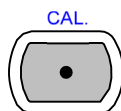

Decimal point and Calibration key.

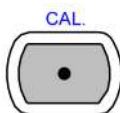

Decimal point.

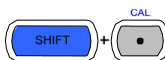

Activates calibration mode.



Note

 Calibration mode is not supported. Refer to the *Calibration* section below for more information.

Clears current values. Alternate function locks the keys and selector knob.



Clears the current value.



Locks all keys and selector knob.

USB Input



USB flash memory slot.

Selector Knob

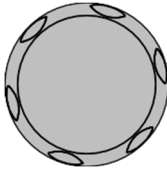

Selects operations and increase/decrease values.

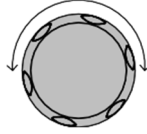

When turned left or right, moves the cursor in menus or changes the selected item or value.

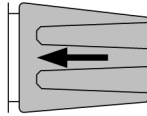

When pressed, acts as the Enter key.

Operation Keys



Saves and recalls preset settings and values.

Press in combination with the number pad to recall or save presets P0-P9.



Inactive.



Active. Use in combination with the number pad and/or shift key.

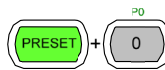

Press to recall a channel preset.

Hold to save a channel preset.

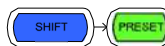

Press to recall all channel presets.

Hold to save all channel presets.

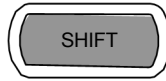

Use the shift key to access alternate functions assigned to select keys. You also can use the shift key to toggle between coarse and fine control mode when used in conjunction with the selector knob to adjust parameters.

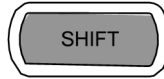

Inactive mode.

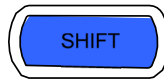

Active. When active, use the shift key to access the Local and Utility menus.

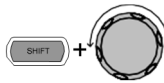

Coarse control mode.

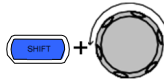

Fine control mode



Confirms selections.



Turns the current load/channel on or off.



Load is off. (unlit)



Load is on. (orange light)

Power

ON / STBY  Turns the unit on or to standby mode.

ON / STBY  Standby mode.

ON / STBY  On.

Display Overview – Mainframe

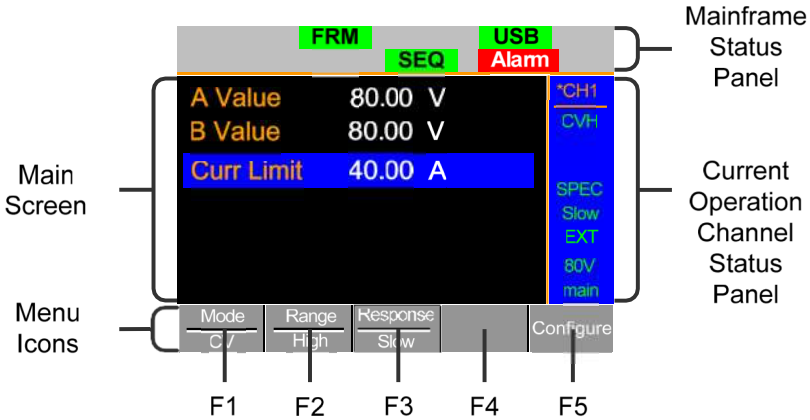

Mainframe Status Panel The Mainframe Status Panel displays the Mainframe interface, programs, and alarm status.

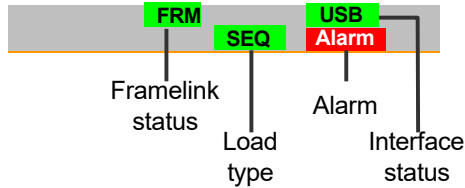

Frame Link Status

Indicates Frame Link is turned on and that the mainframe is set as either a master (FRM) or slave (FRS) unit.

FRS

Load Type

 Indicates whether a Sequence (SEQ) or Program (PROG) is turned on. If not, LOAD is displayed as default. When any Load type is running, its icon turns orange.

Interface Status

 Displays which interface type is set.

Current Operation Channel Status Panel

Generally displays the current channel's status.

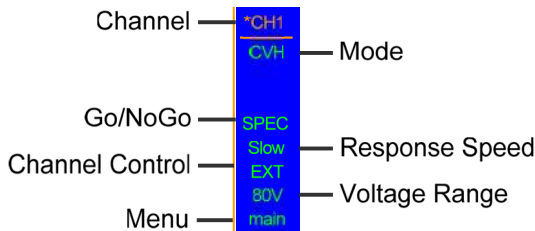

Channel	CH1-CH8	Displays the current channel.
	*CHx	* = independent mode
	CHxS	S = Group Channels
	CHxP	Sync mode
		P = Group Channels
		Parallel mode

Mode	Displays the current mode.	
	CCL	CC Static Low Range
	CCH	CC Static High Range
	CCDL	CC Dynamic Low Range
	CCDH	CC Dynamic High Range
	CRL	CR Static Low Range
	CRH	CR Static High Range
	CRDL	CR Dynamic Low Range
	CRDH	CR Dynamic High Range
	CVL	CV Static Low Range
	CVH	CV Static High Range
	CPL	CP Low Range
	CPH	CP High Range
Go/NoGo	SPEC	If Go/NoGo is on, SPEC is displayed.
Response Speed	Slow Fast	In CV mode, the Slow or Fast response speed is shown.
Channel Control	EXT	When Channel Control is set to External, EXT is displayed.
Voltage Range	Displays the current setting's voltage range.	
Menu	Shows the current menu.	
	main	= Chan menu
	conf	= Chan→Configure menu
	s_edit	= Chan→Seq.Edit menu
	file	= File menu
	s_loop	= Chan→Seq.Edit→Loop menu
Main Screen	Main display screen.	



Menu Icons

F1-F5

The F1-F5 function keys control each menu icon.

Rear Panel Overview

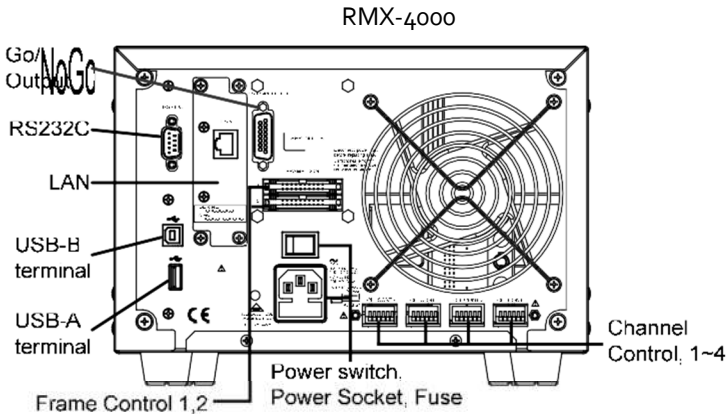
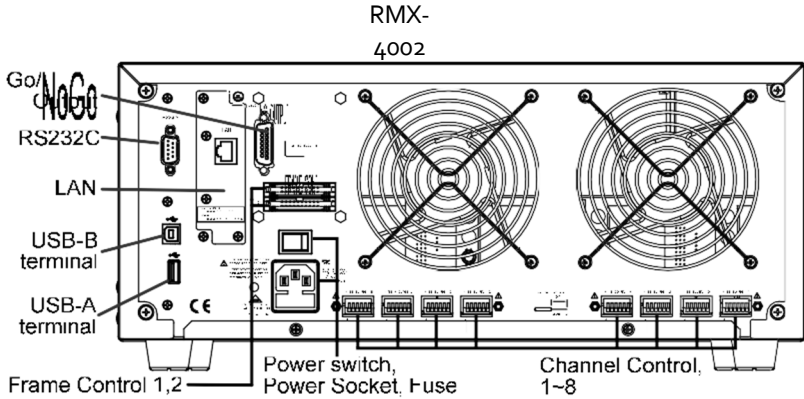

Go/NoGo
Output

GO/NG OUTPUT

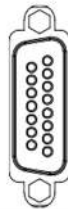

The Go/NoGo Output terminal outputs a pass (high)/ fail (low) voltage for each channel.

Refer to pages 67 and 318 for details.

RS232 port

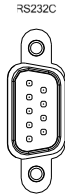

The RS232 port is used for remote control connections.

RS-232C: DB-9 pin male

Refer to page 312 for remote control details.

LAN port

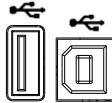

Ethernet port for controlling the RMX-4000 remotely.

USB-A (host)/
USB-B (device)
port

Like the RS232 port, the USB-B (device) port is for remote control. The USB-A (host) port is reserved for power delivery 5 V only. If you use the USB-A (host) as a USB flash memory slot, do not set the interface to USB.

Refer to page 104 for interface details.

Frame Control
Port

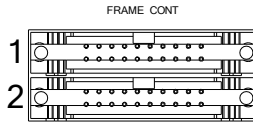

The Frame Control port is for Frame Link connections. Mainframes are daisy-chained together. There are two Frame control ports:

- 1: Slave
- 2: Master

Connection type: MIL 20-pin connector.

For frame link connection details, refer to pages 61 and 315.

Power Switch

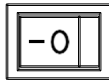

External Power Switch

Power Socket/
Fuse

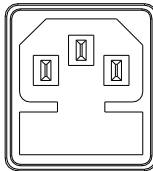

The power supply socket accepts the AC mains Voltage. The fuse holder is below the power socket.

Power: 47-63 Hz

Fuse: T3.15 A/250 V

For fuse replacement details, refer to page 321.

Channel Control port (1-8)



Each channel has a dedicated channel control port to enable external monitoring and control. The channel control port has six wire sockets that are screw-less and self clamping.

Required wire gauge:
24 AWG

For connection or
specification details, refer to
pages 63 and 313.

Front Panel Overview – Load Module

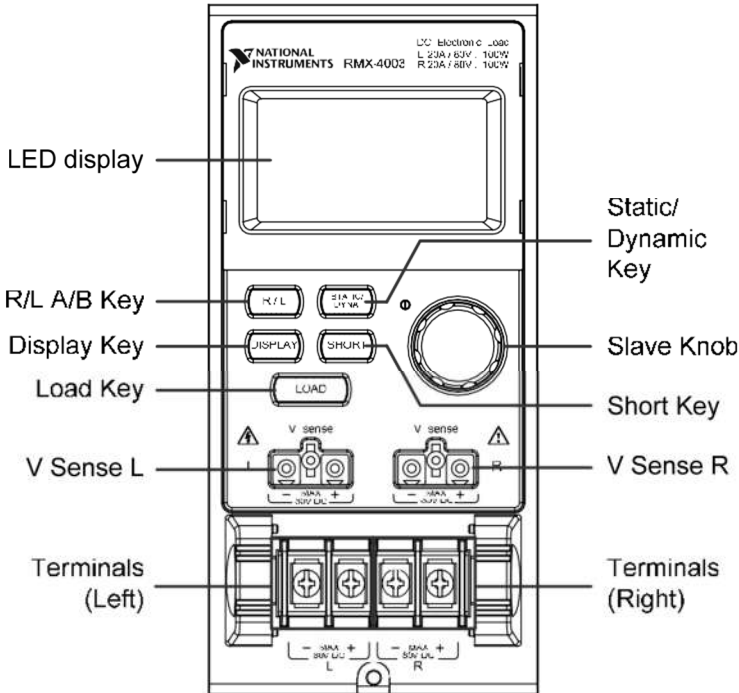

LED display 2 x 5-digit custom LED display.

Right/Left Key
or
A/B Key

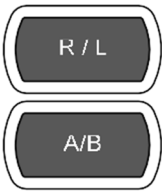

Use the L/R key to switch between the right and left load channel on a dual-channel load module. Use the A/B key to switch between A and B Values for single-channel load modules.

Display Key



Alternates the display output on the load module.

Current

Voltage

Power

Load time

Load Key



Activates the load for the active channel. (right or left/A or B)

Left Voltage Sense

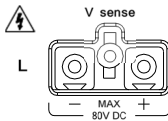

Use the voltage sense terminals when you need precise measurements, to compensate for voltage drops across the main terminals caused by the load wires' resistance.

Right Voltage Sense

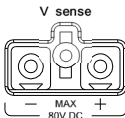

⚠ It is automatically activated when connected to a DUT.

The voltage difference between the DUT and load voltage should not exceed 2 V. Otherwise, you will get an incorrect measurement for the voltage. (Applicable to all models.)

Positive and
Negative
Terminals Left

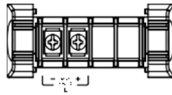

The terminals for both the left and right side of a load can draw differing amounts depending on the load module specifications.

Positive and
Negative
Terminals Right

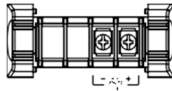

For two-channel load modules, the left terminals are for the first channel, and the right terminals are used for the second channel.

On single-channel load modules, the left terminals are the lower (-) potential terminals, while the right terminals are the positive (+) potential terminals.

Static/Dynamic
Selector Key



The STATIC/DYNA. key manually switches the load from static (manual) to dynamic.

Dynamic loads are supported in only CC and CR mode. For more information, refer to pages 69 and 72.

Slave Knob (Load)



Use the Slave Knob to edit and vary parameters for the active channel on the local load. Depending on the mainframe setup, the Slave Knob updates either the load only (locally) or both the local module and mainframe*. You also can configure the Slave Knob to display measured or set values on the local load module**.

*For more information about knob types, refer to page 233.

**For more information about the Slave Knob, refer to page 237.

Short Key



Use the SHORT key to short circuit the active channel manually on the local active load. When a load is off, the SHORT key toggles the short key type.

You can set the Short key to enable or disable in the configuration setting.

Load on: Pressing or holding the SHORT key shorts the load, depending on the short type selected.

LED Display Overview – Load Module

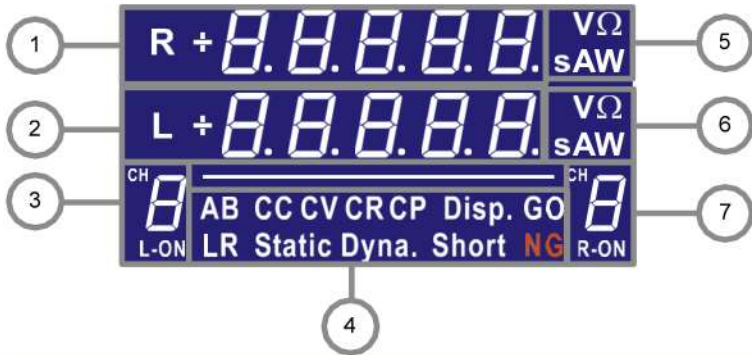

① and ②
Channel Display



R or **L** Left and right channel indicator.



5-digit display.

③ and ⑦
Channel Number
Indicator



Indicates the channel number (1-8).

L-ON

Indicates whether the load is active on the load module for dual-channel load modules.

ON

Indicates whether the load is on for single-channel load modules.

4

Indicator

Mode

The Mode Indicator LEDs indicates the current mode or settings on the active channel(s).

AB CC CV CR CP Disp. GO
LR Static Dyna. Short NG

A or B Value A or B for a single-channel load module. Applies to CR, CV, CP, and CC static mode only.

CC Constant Current Mode (CC) mode activated.

CV Constant Voltage Mode (CV) mode activated.

CR Constant Resistance Mode (CR).

CP Constant Power Mode (CP).

Disp. Display is shown on dual-channel load modules when both left (L) and right (R) channel information is displayed.

Press the Display button repeatedly to show information for both channels.

GO Lights up when Go/NoGo is activated and the load passes the Go/NoGo limits.



L or R L or R lights up when you select the left or right channel.

Static Lights up when in Static mode.

Dyna. Lights up when in Dynamic mode.

Short Lights up when a load is shorted.

NG Lights up when Go/NoGo is activated and the load fails the Go/NoGo limits.

 and 
 Channel Unit
 Indicators



The Unit Indicators display the current unit.

V Voltage

Ω Resistance

A Current

W Power

S Second

Installation

This chapter describes how to load the load modules, install the optional rack mount kit, and determine each channel number.

If you need to move all installed devices to another location, disassemble the modules first, then reassemble the modules after moving to the desired location.

Load Module Installation



WARNING

To avoid static electricity, use appropriate anti-static work practices.

Module installation

The RMX-4000 and 4002 can accommodate two and four load modules, respectively. Module loads can have one or two channels. Load module installation is the same for both models.

Steps

1. Ensure that the mainframe is turned off from the rear panel. Disconnect the power cord.

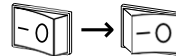

2. Slide the module onto the rails of an empty load slot.

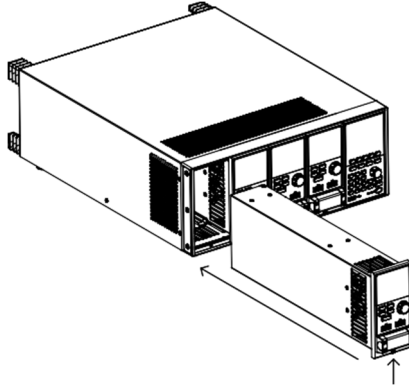

3. Use the supplied screw to attach the module to the load slot under the load terminals.

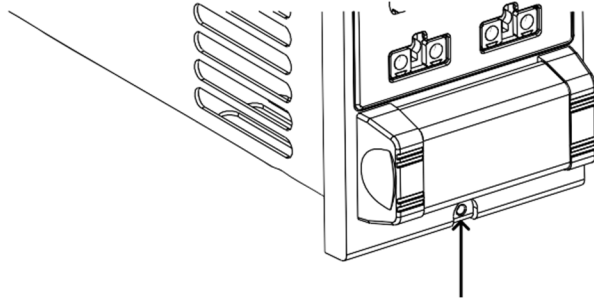

4. Install any additional modules as described above.
5. If there are any empty slots, install the supplied panel cover (National Instruments part number 63FP-AG106501). The panel cover improves safety and increases air flow.

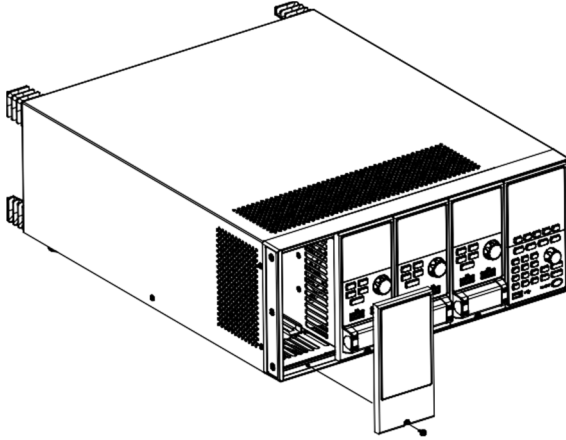

6. Use the supplied screws to attach the panel cover(s) over the load slot.

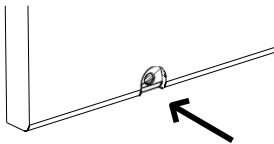

Rack Mount Installation

Background You can use the RMX-4002 in a standard 19 in. rack mount enclosure with the optional rack mount kit (National Instruments part number 11EL-20040201). Each unit requires a rack height of 4U with a 1U space for ventilation top and bottom. The rear of the rack mount enclosure must be free of obstruction to allow heat to dissipate from the mainframe(s).

Steps

1. Attach the rack mount brackets as shown below using the supplied bolts.

RMX-4002

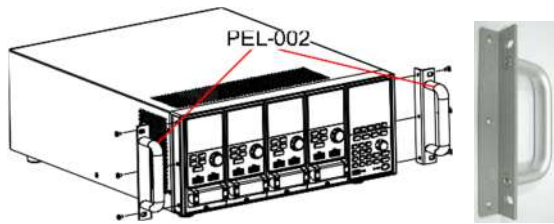

2. Insert the RMX-4002 into a standard 19 in. rack enclosure with at least 1U of space top and bottom for ventilation.

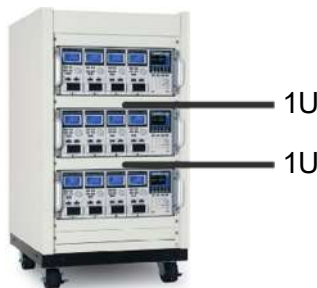

Channel Number

Description The slot a module load occupies on the mainframe chassis determines the module load channel number. There can be one or two channels per slot, depending on the load module type.

The RMX-4000 has two slots; the RMX-4002 has four slots. Channel 1 is the farthest away from the main display panel, and channel 8 (RMX-4002) or channel 4 (RMX-4000) is the closest to the main display panel.

As shown in the following figure, the RMX-4002 has all four slots occupied with the RMX-4003, RMX-4004, RMX-4005, and RMX-4006 load modules (LM), respectively. The RMX-4003 and 4004 have two channels per load module; the RMX-4005 and RMX-4006 have only one. The channel determination is:

LM1: CH1, CH2; LM2: CH3, CH4; LM3: CH5;
LM4: CH6.

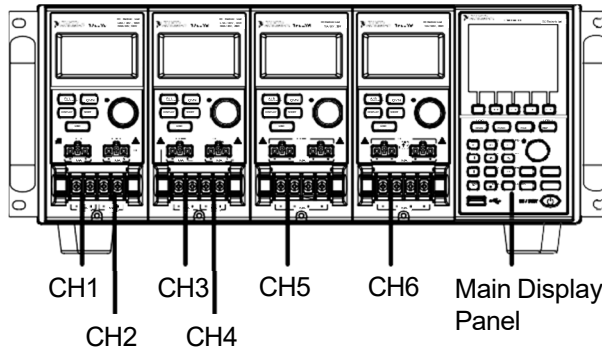

Power Up and Self Test

Panel Operation

1. Connect the power cord to the power socket.

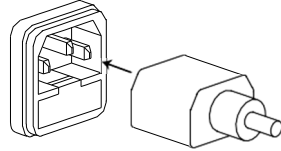

2. Turn on the external power switch.

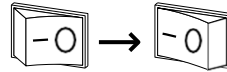

3. Hold the power button on the front panel to turn on the power.



The power button turns from red (standby) to green.

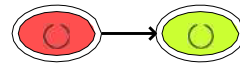

WARNING

Ensure that the power outlet has a ground socket. The power outlet has a ground connection if it is a three-socket type.

When turned on, the Mainframe performs a self-test. The self-test checks the system, followed by any attached channels.



NOTE

When the mainframe and slave firmware versions are not identical, the following message appears on the mainframe: "The firmware will be updated, please access to website www.ni.com to confirm the firmware version."

Initial	System	Success
	CH1	Success
	CH2	Success
	CH3	Success
	CH4	Success
	CH5	Success

When the system check happens, the load modules display each channel as it is checked, then display the current mode.

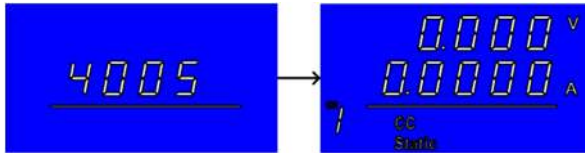

- If any System checks fail, power down the load and reinstall the appropriate load module(s).
- To turn off the load, hold the power button for a few seconds.



The RMX-400x mainframe returns to standby mode.

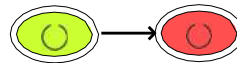

Load Connections

Precautions and Procedures

Introduction The RMX-400x series supports several load configurations for flexible operation:

- Single DUT, single load
- Single DUT, parallel load
- Multiple DUTs, multiple loads
- Multiple DUTs, multiple mainframe loads
- Single DUT, parallel mainframes

The RMX-400x series also supports a number of different control methods and interfaces. The connections used are described here:

- Frame link
- Channel control
- Go/NoGo

Wire Gauge Considerations Before connecting the RMX-400x series, you must consider the wire gauge. Load wires must be large enough to resist overheating when a short-circuit condition occurs, as well as maintain good regulation. The size, polarity, and length of a wire are all factors in determining if it can withstand short circuiting.

Wire Selection Wires must be large enough to withstand a short circuit and limit voltage drops to no more than 2 V per wire. Use the table below to help make a suitable selection.

AWG	Max Current (Amp)
24	7.64
22	10.0
20	13.1
18	17.2
16	22.6
14	30.4
12	40.6
10	55.3

Load Line Inductance Considerations When using the RMX-series, you must consider the voltage drop and voltage generated due to load line inductance and current change. Extreme changes in voltage may exceed the minimum or maximum voltage limits. Exceeding the maximum voltage limit may damage the RMX-400x series.

To determine the voltage generated, use the following equation:

$$E = L \times (\Delta I / \Delta T)$$

E = voltage generated

L = load line inductance

ΔI = change of current (A)

ΔT = time (us)

You can approximate load line inductance (L) as 1 uH per meter of wire. ($\Delta I / \Delta T$) is the slew rate in A/us.

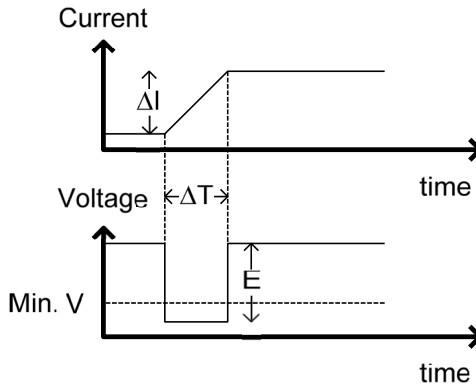

The diagram above shows how changes in current can affect voltage.

Limiting Load Line Inductance

You can reduce load line inductance by ensuring load wires are as short as possible and twisting positive and negative load wires together. You can limit current change by limiting the slew rate when switching.

A twisted pair is shown on any connection diagram where you should twist the load wires together.

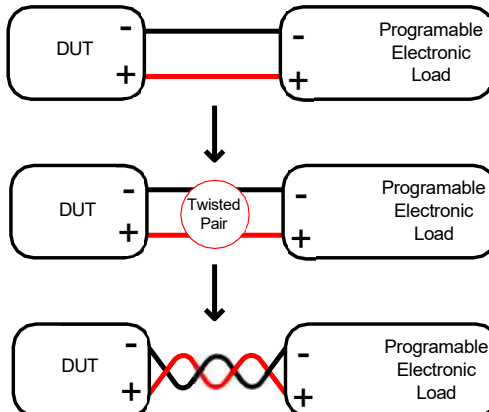

Load Module Considerations

The RMX-400x series supports single and dual-channel load modules.

Single-channel load modules have one bank of negative terminals and one bank of positive terminals. Each terminal pair has a 40 A capacity. For higher loads, you can wire each terminal in parallel to increase capacity.

Dual-channel load modules have one bank of positive and negative terminals for each channel.

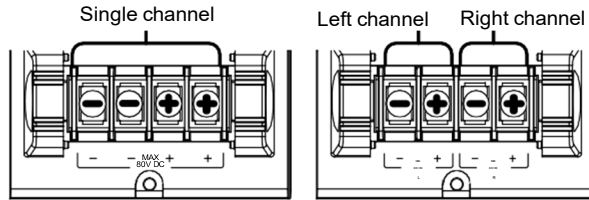
Single-Channel Load Module
Dual-Channel Load Module

Connection

Follow the procedure below for all load connections.



CAUTION

Ensure that power is off from the load and the DUT before making any connections.

Steps

1. Carefully lift the terminal covers.
2. Connect the positive (+) terminal on the load module to the DUT high potential output.
3. Connect the negative (-) load terminal to the DUT low potential output.

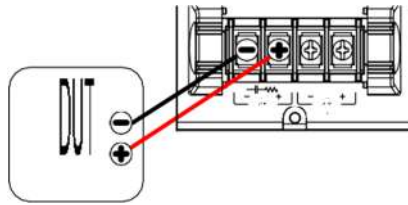

4. Close the terminal cover securely. Ensure that the wires are secured properly and the wires are not exposed when the cover is in place.

WARNING

Ensure that the wires are tied or twisted together to prevent noise and inductance.

CAUTION

Ensure the polarity is correct before proceeding with any connections. Using the wrong polarity could result in reverse voltage damage.

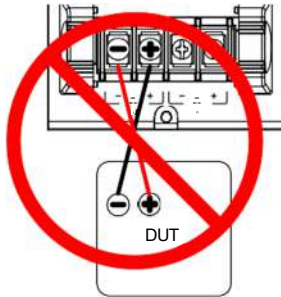

Ensure that the input voltage does not exceed specifications. Exceeding the voltage specifications could result in damage to the instrument.

Remote (Sense) Connection

Background The electronic load modules have two voltage sense contacts: V_{sense+} and V_{sense-} . You can use voltage sense to help compensate for long cable length. The longer the cable, the higher the potential resistance and inductance; therefore, a short cable is best. Twisting the cable can help reduce induced inductance, and using the V_{sense} terminals compensates the voltage drop seen across the load leads, especially leads with higher resistance. This is useful when used in CV, CR, or CP mode.



WARNING

V_{sense+} must have a higher potential than V_{sense-} .

Connection The diagram below shows how you can connect a DUT using voltage sense. Note that the sense wires are also twisted pairs.

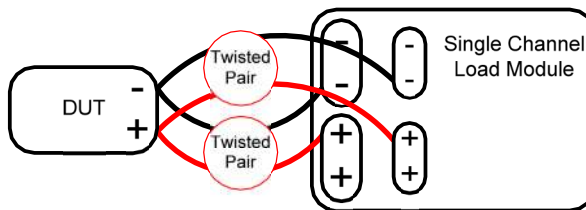

Note

The wire gauge for the sense wires should be no smaller than 16 gauge.

Input The voltage sense terminals must use a wire gauge of 16 to 14 (diameter 1.29 mm - 1.63 mm).

Remote Sense Terminal connection

The voltage sense terminals use a screwless clamp connector. You must open the clamp prior to inserting a wire. Use a small screwdriver to push the clamp release mechanism, as shown below. Insert both wires, then release the clamp mechanism.

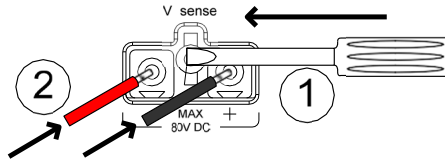

Single-Load Connections

Dual Channel Load Module Connection

You can use a dual-channel load module to sink two loads concurrently.

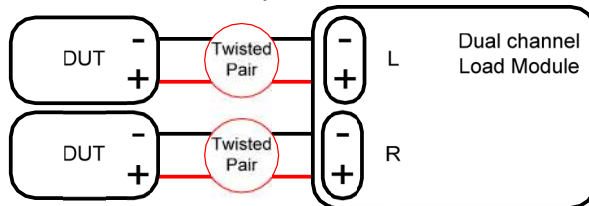

Single Channel Load Module Connection

On a single-channel load module, the left terminals are both negative (-), while the right terminals are both positive (+). Note that this also applies to the voltage sense terminals.

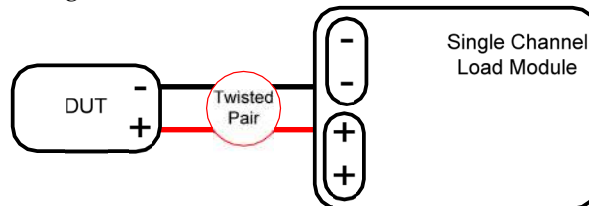



For loads exceeding 40 A, you must use both positive and both negative terminals in parallel.

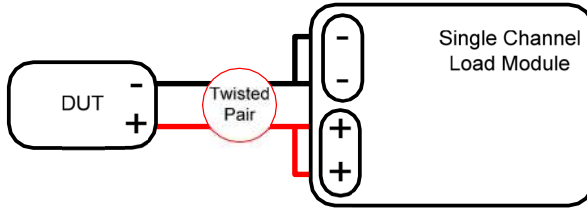

DC Connection

For purely DC operation, you can connect a resistor and capacitor in parallel to the electronic load to reduce oscillation. The capacitor and resistor values depend on the load settings. Ensure that the capacitor ripple current is within allowable limits.

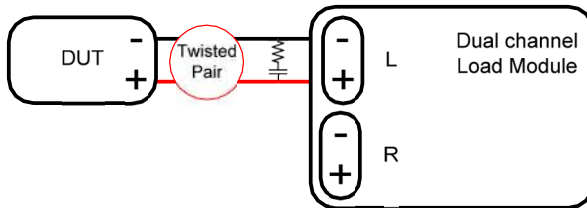

Low Voltage Connection

Using the load with low voltage loads is generally limited to over 1 V (load module dependent). To support low voltage loads, you need an auxiliary power supply to boost the voltage to a range suitable for the load.

Precautions:

- Take into account the combined power of the load and auxiliary power supply.
- Make sure the auxiliary power supply can provide enough current.
- Take into account any noise or irregularities from the auxiliary supply.

The diagram below shows a typical connection.

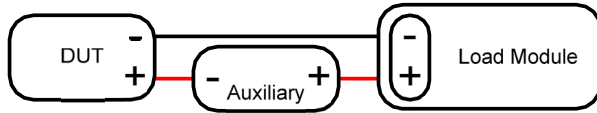

WARNING

Using an auxiliary power supply may induce reverse current. The RMX-400x Series has reverse voltage protection. For details, refer to the protection section on page 92.

Parallel Load Connections

Parallel Load Modules

When the power output of a DUT exceeds the power rating of a channel or load module, you can use the channel terminals, load modules, or mainframes in parallel to dissipate more power when used in CC or CR mode. Each channel sinks the amount of current specified. The total power sunk is the sum of all channels/modules. The amount of power can vary from each channel. For example, if CH1 is 25 A and CH2 is 20 A, the total current sunk is 45 A. Parallel loads are supported for both static and dynamic loads (refer to page 90 for a description on parallel dynamic loading). Note that you must use the same modules when operating the parallel.

The RMX-400x series also features a dedicated parallel configuration setting known as Group Unit. When Group Unit is turned on, you must use load modules of the same type and rating in parallel for CC and CR mode. Refer to pages 80 and 221 for more information.

Parallel Load

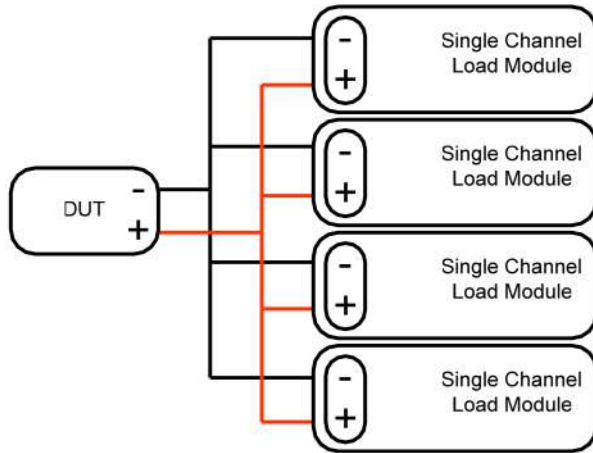

Note

You must use the same load modules in parallel.

Parallel Loads Using Frame Link Connections

You also can connect RMX-400x series mainframes in parallel. When using a frame link connection, there is a delay between the master and slave. Refer to page 61 for details.

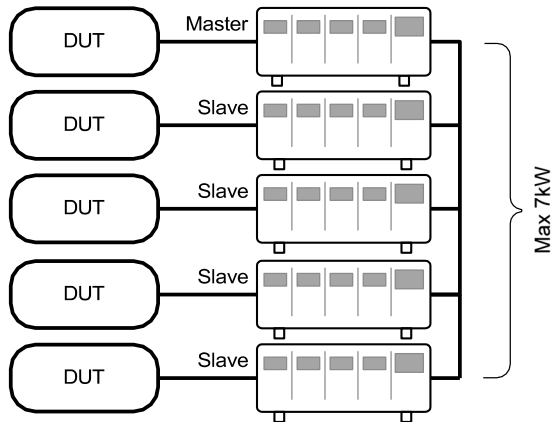

Mult i-Output Power Supply Load

The RMX-400x series also can sink a number of loads concurrently from multiple DUTs or sink a number of loads from the same DUT (that is, a multiple output power supply).

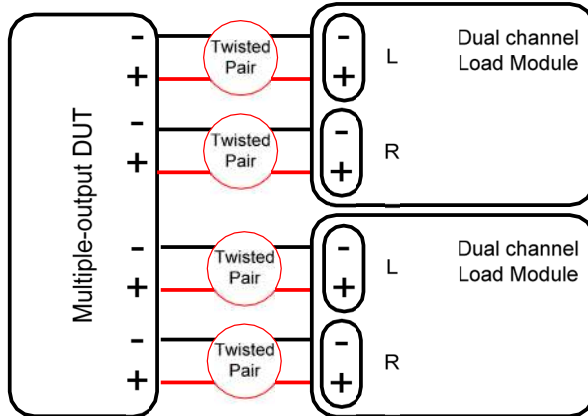

Frame Link Connection

Background

Frame link control involves connecting multiple mainframes using the frame link connections. You can connect up to four slave mainframes to the master mainframe. You can use the first mainframe (master) to control the other slave frames. There is a delay time of $2\ \mu\text{s}$ between the master and first slave mainframe, and $4\ \mu\text{s}$, $6\ \mu\text{s}$, and $8\ \mu\text{s}$ to the second, third, and fourth slave mainframes, respectively. The connectors used are standard MIL 20-pin connectors. For pin arrangement, refer to page 315. The frame link cable (part no. GTL-249) is an optional accessory; refer to page 18 for details.

Frame Link Connection

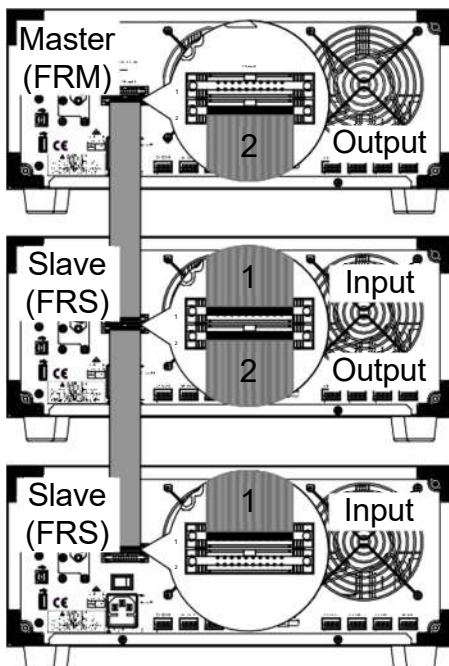

The first mainframe connected is the master frame; any additional frames are slave units. The ribbon cable connects to the master from connector 2, and the slave from connector 1. Each successive slave unit is connected in a cascading manner the same way.

Ensure that the mainframes are turned off before connecting the ribbon cables. Push the cable into the frame link connector. Ensure that the arrows line up. The latches close when the connection is complete. To remove, pull the latches out, and the connector comes out.

Insertion

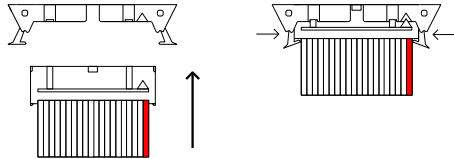

Removal

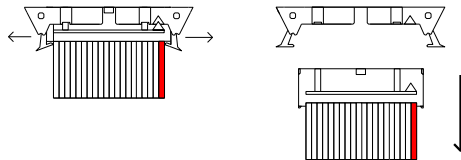

Ensure that all the mainframes are off and disconnected from mains power before connecting.

Channel Control Connection

Background

The Channel Control connectors are on the rear panel of each mainframe. There are two channel control connectors for each load slot, one for each channel, if applicable. Use the channel control connector to externally:

- Turn on/off loads.
- Supply a reference voltage.
- Monitor the load input.

For further details on channel control and the interface, refer to pages 100 and 313.

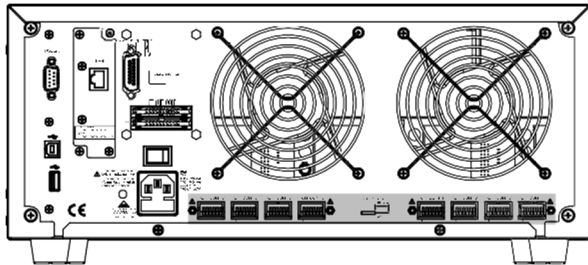

The Channel Control input/output pinout is shown below.

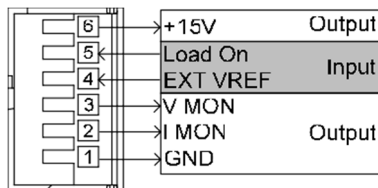

External Voltage Connection The external voltage reference input must be 0-10 V.

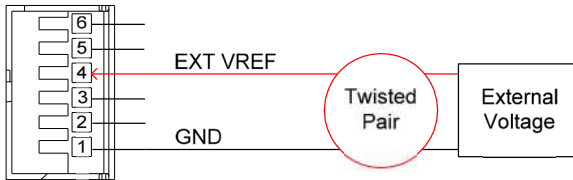

WARNING

Ensure the external voltage reference is stable and has low noise. The External Voltage should be no more than 10 V.

You can use an external voltage of no more than 12 V. More than 12 V may damage the load.

Load on connection

To turn a load on, you must apply an active low voltage (0-1 V) across Load On (pin 5) and GND (pin 1). Similarly, you must apply an active high voltage (4-5 V) to turn a load off. The Load On input must be TTL.

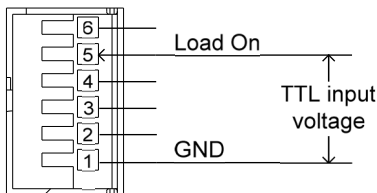

Voltage and Current Monitor Output

The Voltage Monitor Output (VMON) and Current Monitor Output (IMON) output the load input voltage and load input current as a percentage of rating current/voltage, where 0 V = 0% rating and 10 V = 100% load input rating voltage or current.

The voltage monitor output is across pins 1 and 3, and the current monitor output is across pins 1 and 2. Pin 6 outputs a +15 V reference voltage.

The following diagram shows the voltage and current monitor output pin configuration.

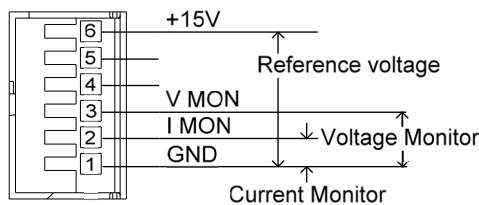

Connector Connection

The channel control connector is a screwless clamp connector. You must open the internal clamp mechanism before you can insert a wire. To open the internal clamp, push the button above the wire socket. To close, release the button. Ensure that at least 10 mm is stripped from the wire. The diagram below shows the wire insertion procedure.

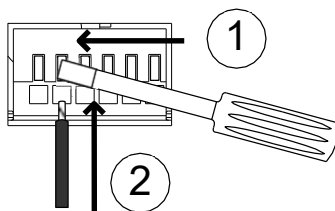

**WARNING**

All connections to the channel control connector must use a 24 AWG wire gauge.

Go/NoGo Connection

Background The Go/NoGo port is a 15-socket port. Each channel has a dedicated line for a Go/NoGo output. The ports are open-collector with active high (30 V) indicating a pass and active low (1.1 V) indicating a fail (an alarm). The Go/NoGo terminal is a DB-15 female.

For more details on the Go/NoGo interface, refer to page 318.

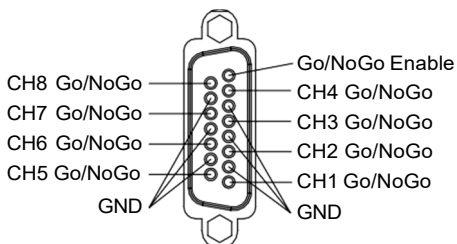

OPERATING DESCRIPTION

Operating Mode Description	69
Constant Current Mode	69
Constant Resistance Mode.....	72
Constant Voltage Mode	75
Constant Power Mode	78
Group Unit Mode.....	80
Run Program	82
Sequence	85
OCP Test Automation.....	90
Parallel Dynamic Loading	91
Configurations Description.....	92
Protection Modes	92
Operating Configurations	94
Channel Control.....	100
Interface and System	104
Interface.....	104
File System.....	104
File Format	110

Operating Mode Description

There are four basic operating modes: constant current (CC), Constant Resistance (CR), Constant Voltage (CV/CV+CC) and Constant Power (CP). All channels operate using any of the modes. Each mode has a number of configurable options including slew rate, levels, protection modes, Go/NoGo and extensive save options.

Constant Current Mode

Background In Constant Current Mode, the load units sink the amount of current programmed. Regardless of the voltage, the current stays the same. There are two ranges in CC mode: High and Low. There are two main modes in CC mode: Static and Dynamic. You can use static mode for stability tests and dynamic mode to test transient load conditions.

Go/NoGo is supported for both High and Low range as well as Static and Dynamic mode.

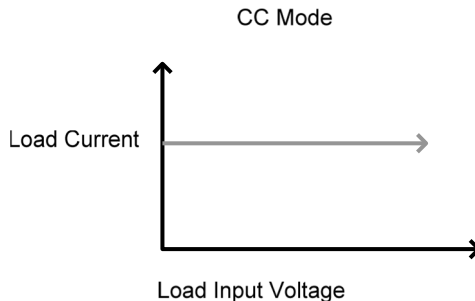

Range There are two selectable ranges for constant current mode: high and low range.

Low range has a higher resolution, but a lower range. If the current exceeds the Low Range, you must use High range.

Static Functions Static mode tests the stability of the voltage output from a power source. Single-channel load modules can have two current levels: A (A Value) and B (B Value). A and B have the same range. Pressing the A/B key on the module load cycles through the A and B states. Alternatively, the mainframe can select the A or B Value.

Dual-channel load modules have only one current level (A Value) per channel in static mode.

Static Mode:
Single Channel
Load module.

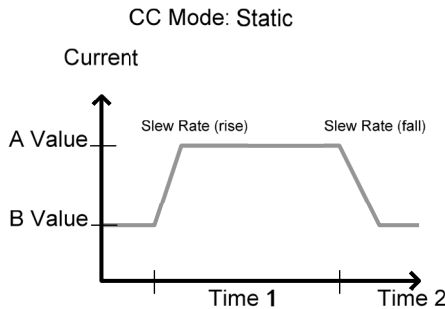

Dynamic Functions Dynamic load functions allow you to set load levels (Level 1 or Level 2), load time (Timer 1 or Timer 2), and the slew rate (rising or falling). Depending on the settings, the load switches automatically between levels 1 and 2.

You can use dynamic loading for charge discharge cycle testing, and so on.

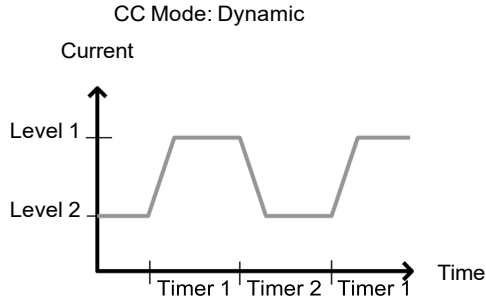

Slew rate

The slew rate is the rate at which the current increases to a set level. There are two slew rates: rising slew rate and falling slew rate. In CC mode, the slew rate is defined as A/ μ S.

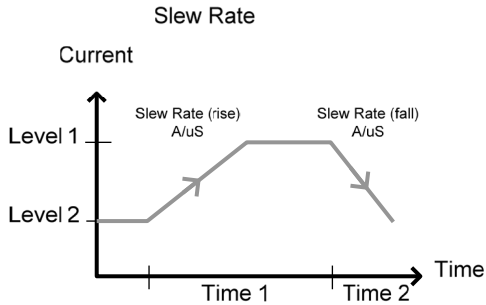

As shown above, the rising and falling slew rate need not be the same.

Go/NoGo

Using Go/NoGo, you can set the Center, High, and Low voltage limits for both Static and Dynamic modes. You also can set a delay time of up to 1 second.

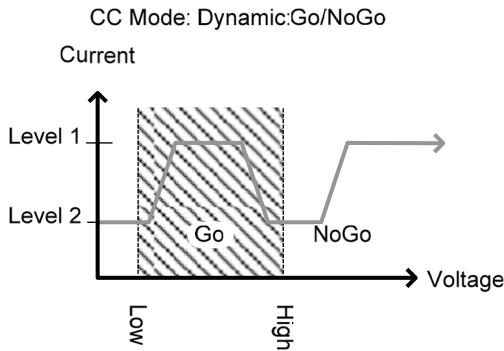
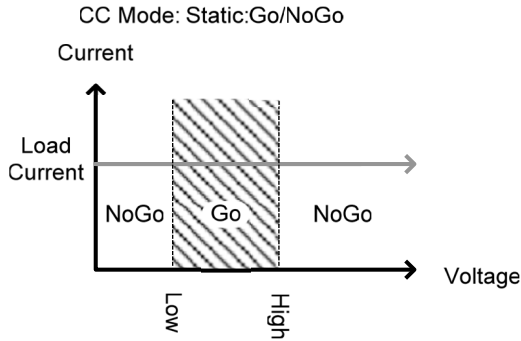

GO is specified as between the Low and High Go/NoGo limits. NoGo is specified as outside the Go/NoGo limits.

Constant Resistance Mode

Background

In constant resistance mode, the load units linearly sink current and voltage to match a set resistance. CR mode has two values (single load modules), two ranges, and rising and falling slew rates. Like CC mode, constant resistance mode supports both dynamic and static loads. As with the other modes, Go/NoGo is supported.

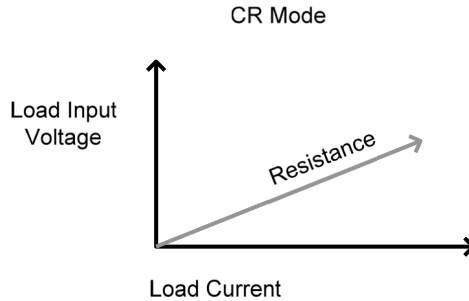

Resistance Range There are two ranges: high and low. The low range is for low-voltage ranges, while the high range is for high-voltage ranges. The current range always remains in high range, regardless of the selected resistance range.

Static Functions A/B range For static mode, single-channel load modules have two resistance levels, A and B Value. A and B have the same range. Use the A/B key to switch between these resistance levels. Dual-channel load modules have only one resistance level, A Value.

Single Load Module

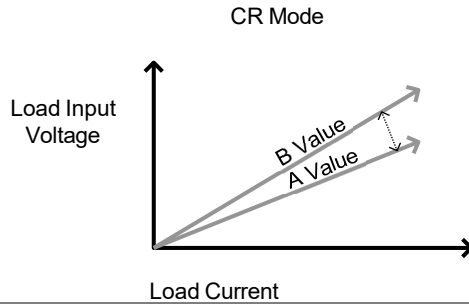

Dynamic Functions CR mode supports Dynamic loading. Dynamic load has two resistance levels (Level 1 and 2), and two timers (Timer 1 and 2) to switch between the resistance levels. You can set rising and falling slew rates to determine the speed at which the load switches between load levels.

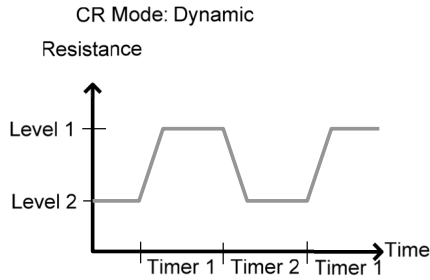
Slew Rate

The rising and falling slew rate (A/ μ S) determines the speed at which the load levels change from A to B Value (static mode) or from Level 1 to 2 (dynamic mode) and vice versa.

Go/NoGo

Go/nogo is also supported. You can set center, high, and low limits as either percentages or voltage values. You also can set delay time of up to 1 second.

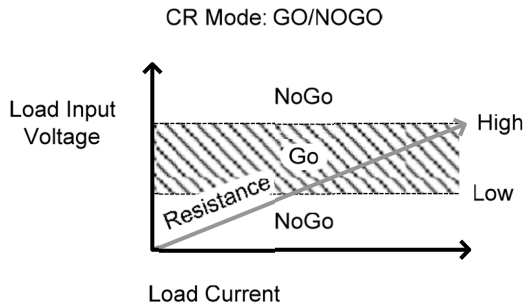

Constant Voltage Mode

Background In constant voltage mode, the load units sink current while keeping the voltage constant.

Single-channel load modules support two values (A Value and B Value) and have an adjustable cut-off current limit. Dual-channel load modules have only A value.

You also can set response speed to fast (Fast) or slow (Slow). The response speed relates to the current response's slew rate.

Go/NoGo functionality is also supported either as a percentage or as a current value.

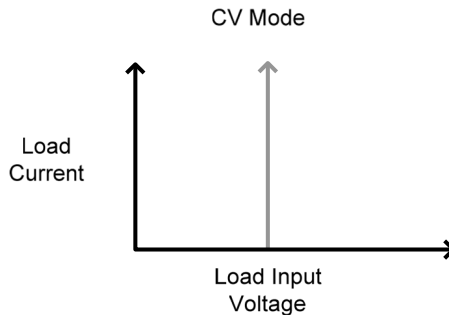

Voltage levels You can set two voltage levels: A and B (single channel load module).

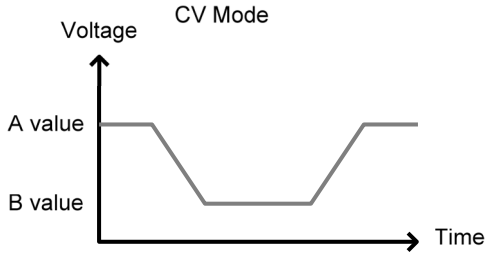
CV + CC

When using CV mode, you can set a current limit for CV + CC mode.

When the voltage input is greater than A Value (load voltage), the channel operates in CV mode if the input current is less than the current limit. When the input current exceeds the current limit, the channel operates in CC mode.

When the voltage input is less than A Value (load voltage), current stops flowing.

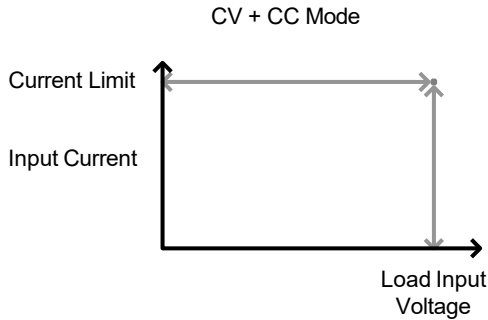

Response Speed You can set response speed to fast or slow. The load module specifications determine fast response and slow response. Slow response speeds are suitable for large loads, as quick current changes induce induction that can cause large voltage drops. The RMX series tries to rectify any voltage drops. However, if voltage drops are too large, they may cause the load to go into oscillation. Large voltage drops that line voltage induction causes may damage the machine.

Range	Fast	Slow
	1 kHz	100 Hz

Go/NoGo Go/nogo testing can be with either current (Ampere) values (High or Low) or percentage values (Center, High %, or Low %). You also can set a delay time of up to 1 second.

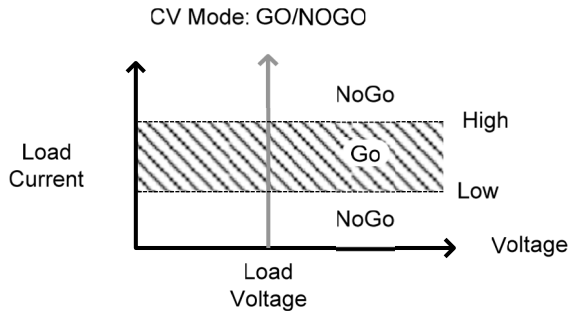

Constant Power Mode

Background In constant power mode, the load units ensure a constant power load for the power supply.

Single-channel load modules support two values (A Value and B Value) and have an adjustable cut-off current limit. Dual-channel load modules have only A value.

Constant power mode can operate in high or low range.

Constant power mode also supports Go/NoGo functionality as either a percentage or current value.

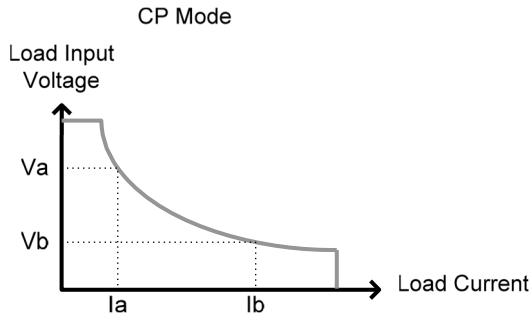

Power Levels You can set two power levels: A and B (single-channel load module).

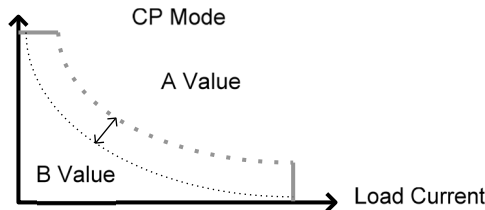

CP + CC When using CP mode, you can set a current limit for CP + CC mode.

When the constant power current is less than current limit, the channel operates in CP mode. When the constant power current exceeds the current limit, the channel operates in CC mode.

High/Low Range There are two ranges: high and low. The low range is for low power ranges, while the high range is for high power ranges.

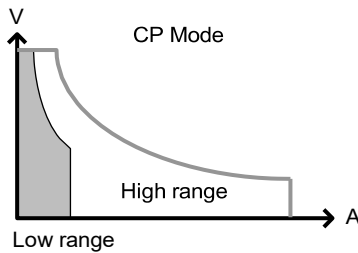

Go/NoGo Go/nogo testing can set high and low current limits as a value (in amperes) or as a percentage. You also can set a delay time of up to 1 second.

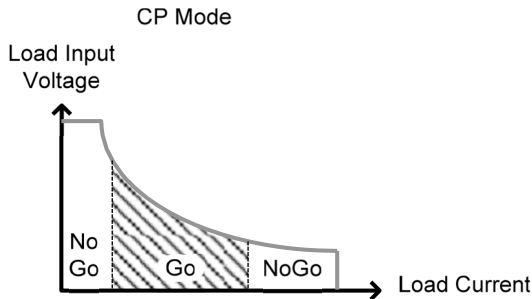

Group Unit Mode

Background Use the Group Unit menu to configure load modules of the same type and rating as a single unit when used in parallel. This eliminates the need to configure each channel individually.

Group Unit is supported under only CC and CR mode.

Group Unit has three configuration settings: Total Unit, Group Mode, and Display Mode.

Total Unit This configuration setting sets the number units to be used in parallel and enables or disables the Total Unit mode.

Group Mode The Group Mode setting determines how the current levels/resistance values are set when used in parallel. There are two settings: para and sync.

The para setting allows the all the parallelized load modules to be operated as a single large load module.

Sync mode allows the settings of a single unit to be synchronized across all the other parallelized load modules.

CC Example Consider three load modules set to CC mode in Parallel.

In CC mode, the total current for all units is the sum of each unit.

$$\text{Total } I = I_1 + I_2 + I_n$$

For example, to set a total load current of 90 A, the current level setting in para mode would be 90 A, while it would be 30 A sync mode.

Para Mode

Level1	90 A	CHIP
Level2	30 A	CHIP
SlewRate ↑	0.80 A/uS	
SlewRate ↓	0.80 A/uS	
Timer1	0.025 mS	
Timer2	0.025 mS	
Mode	Range	Dynamic
CC	High	

Sync Mode

Level1	30 A	CHIP
Level2	30 A	CHIP
SlewRate ↑	0.80 A/uS	
SlewRate ↓	0.80 A/uS	
Timer1	0.025 mS	
Timer2	0.025 mS	
Mode	Range	Dynamic
CC	High	

CR Example

When used in CR mode, the equation for equivalent resistance for all parallel loads is:

$$\frac{1}{R_{eq}} = \frac{1}{R_1} + \frac{1}{R_2} + \frac{1}{R_n}$$

For example, if two load modules have a set resistance of 100 Ω each, the equivalent resistance of the load modules would be 50 Ω. The Level setting in para mode would be 50 Ω, and 100 Ω in sync mode.

Para mode

Level1	50.0000 Ω	CHIP
Level2	100.0000 Ω	CHIP
SlewRate ↑	0.40 A/uS	
SlewRate ↓	0.40 A/uS	
Timer1	0.025 mS	
Timer2	0.025 mS	
Mode	Range	Dynamic
CR	High	

Sync mode

Level1	100.0000 Ω	CHIP
Level2	100.0000 Ω	CHIP
SlewRate ↑	0.40 A/uS	
SlewRate ↓	0.40 A/uS	
Timer1	0.025 mS	
Timer2	0.025 mS	
Mode	Range	Dynamic
CR	High	

Display Mode Display mode determines what units are displayed on the local load modules: V/I, V/W, I/W, and S. You can control the displayed units through only this menu.

Run Program

Background The program function on the RMX-400x Series supports a total of 12 programs at any one time, with 10 sequences to each program. You can chain up to 12 programs. The program function can create several go/nogo tests.

Group Mode does not support Run Program (refer to page 80).

Program Sequence A program sequence is a single load test. A program is a battery of each of these tests run in succession. Each sequence loads the settings for each channel from memory mata (memory MXXX). The memory data stores settings such as the operating mode and range for each channel. Each sequence loads all channels at the same time, unless programmed otherwise. Sequences for each channel run synchronously.

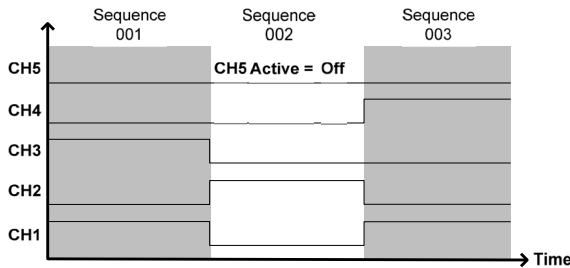

Each sequence has several configuration options that apply to all the channels equally.

Sequence Item	Description
Memory	Loads the channel settings for each load module. Range: M001-M120
Run	Sets the running configuration for the current sequence. You can skip the sequence, run it, or run manually only. Range: Auto Skip Manual
On-Time	Sets the Sequence Run On-Time Range: 0.1 s-60.0 s
Off-Time	Sets the sequence off-time Range: Off 0.1 s-60.0 s
Short-Time	Sets the sequence short-time. Range: Off 0.1 s-On-Time
P/F-Time	Sets the sequence Pass/Fail time Range: Off 0.1 s-(On-Time+Off-Time)-0.1s
Short Channel	Selects which channel is shorted during the sequence Range: CH1-CH8

Program

Sequences are run sequentially to create a program. There are 10 sequences in each program.

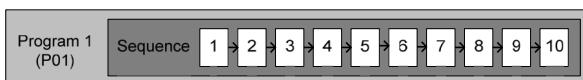

If you want less than 10 sequences in a program, you can skip any additional sequences.



Sequence 2 and 3 are skipped.

Program Chain

You can chain any of the 12 programs to create a program chain. Unlike program sequences, you don't need to run program chains sequentially in numerical order. You can chain any program to any program. You also can chain programs into an infinite loop to continue a program indefinitely.



Above, a program chain running sequences out-of-order.

Go/NoGo Results

If you have configured go/nogo limits, the pass/fail results for each channel are displayed for all sequences and programs.

Program no.	P	S	1	2
Sequence no.	1	1	G	N
Channel	1	2	G	N
	1	3	G	N
	1	4	G	G

Channel

Go/NoGo

Exit

Sequence

Background Use the sequence function to create high-resolution load simulations. You can configure each sequence to create a unique load profile to accurately simulate loads in real time. Sequences are applicable for only CC (Static) and CR (Static) modes.



Note

Note: Do not confuse sequences with the sequences used to create a program. They are not the same, and you cannot use them interchangeably. You cannot use sequences (SEQ memory) in programs, and programs cannot load Sequences.

Load Profiling The sequence function can simulate a load to a high resolution. Each channel can change its load sink within 25 us - 60000 s per point independently. When used in parallel, you can set multiple loads concurrently to simulate the loads placed on multiple output power sources.

The following diagram shows a DUT load profile at start-up.

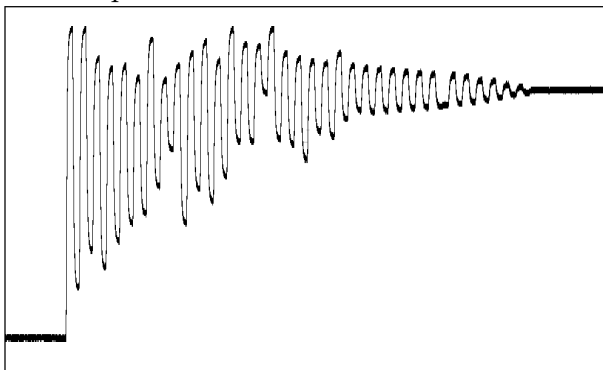

Points

You can use up to 120 points with each sequence. Each point can have a different duration, slew rate, and value.

You can insert or delete a new point at any stage of a sequence. Any new point you insert has a value averaged from its neighbors as default.

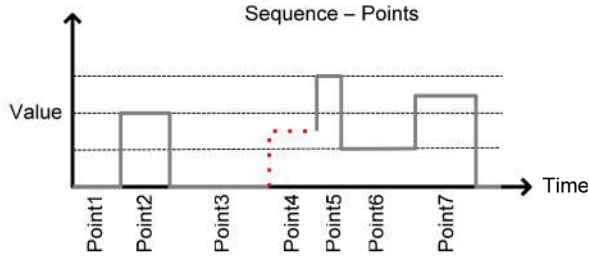

A new point inserted after Point 3.

Loop

You can program sequences to loop a number of times starting from any point in the sequence.

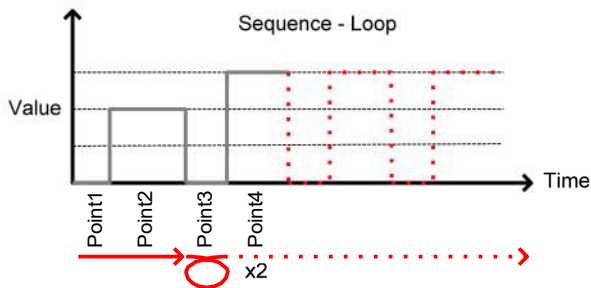

From Point 3, the sequence is looped two times.

On End Of Seq.
function

If you program more than one sequence on the mainframe, the On End Of Seq. function holds the load current (of the selected sequence) to a designated value until all other sequences finish running.

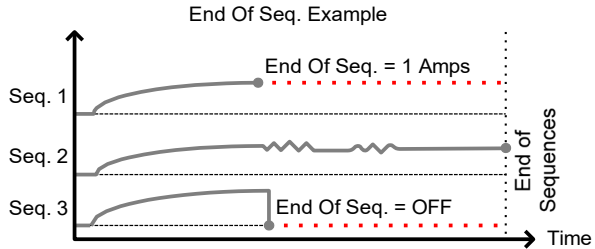

In the example above, sequence 1 holds the load current at 1 A at the end of its sequence until the last sequence finishes. Sequence 2 is the longest sequence, and as such the End of Sequence setting is not applicable. Sequence 3 is turned off after its sequence has finished (0 amps).

Trig Out

The Trigger Out function allows a trigger sequence signal to be output from a channel via PIN 4 on frame link connector 1 when using sequences. The Trig Out function is in the Channel Duration menu.

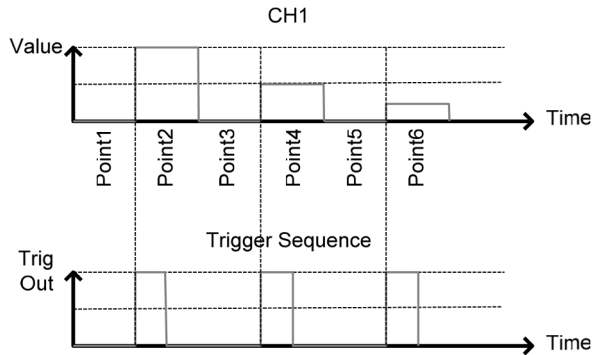

As shown above, a trigger sequence signal is output for every rising edge point.

Trig In

The Trigger In setting allows a sequence to start after a trigger (Trig Out) is received via the frame link connector. The Trig In setting is for frame linked mainframes.

Channel Duration Time Setting

The Channel Duration Time Setting feature allows the point time duration of one sequence to be imported by another sequence. If the receiving sequence does not have enough points, more are created (without values).

For example, the sequences for CH1 and CH2 are shown below. CH1 has a total of six points with long durations, while CH2 has only two points, looped five times. The points from CH2 are also significantly shorter in duration.

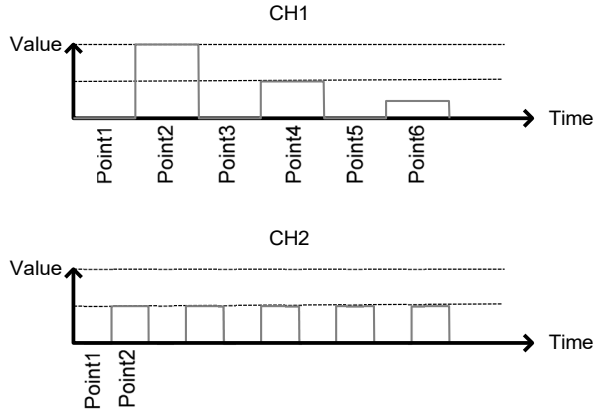

The following figure shows the resulting sequence when CH1 imports CH2. CH1 imports the duration time settings and number of points from CH2, but not the value data.

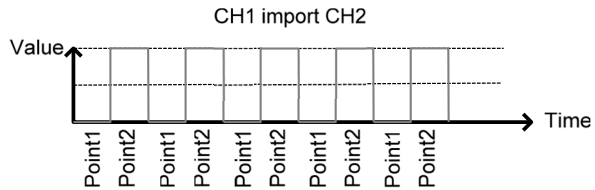

OCP Test Automation

Background The OCP Test Automation function creates an automatic test to test the over current protection of power supply products. Refer to page 189 for operation details.

This test finds when the over current protection of a power supply is tripped and returns the measurements for the voltage and current when the over current protection was tripped. The RMX-400x series also has a user-defined OCP setting in the event that the power supply OCP fails.

The diagram below shows an example of the OCP Test Automation function.

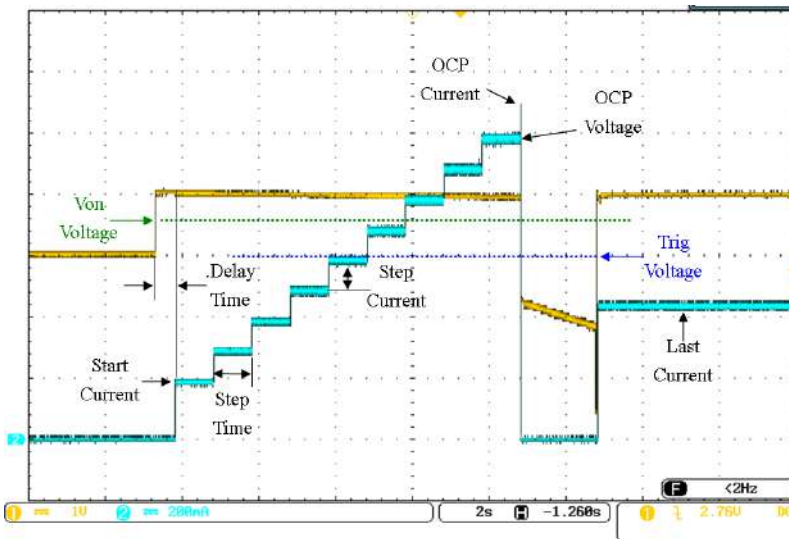

Parallel Dynamic Loading

Background The RMX-400x Series of DC electronic loads support parallel dynamic loading. This means that when the load modules of a mainframe are connected in parallel and set to dynamic mode, they can perform dynamic tests synchronously following the same clock. Under dynamic mode, load current or resistance is pulsed between two preset levels. When used in parallel, you can test higher powered outputs. This ability gives the RMX-400x Series the flexibility to perform dynamic tests over a wide range of power outputs.

For connection details, refer to the *Parallel Load Connections* section on page 58.

The diagram below shows how two load modules can sink a higher load when used in parallel under dynamic mode.

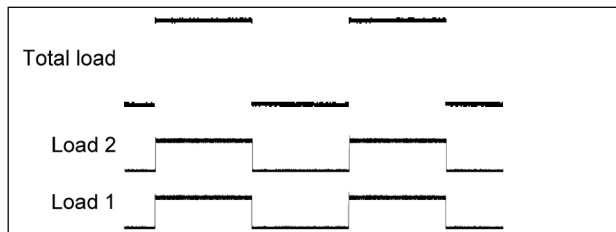

Note

You must use the same type of load modules operated in parallel.

Configurations Description

There are several configurations for the RMX series, including protection modes, operating configurations, and file system configurations. This section describes what the configurations are for and how they are relevant to different operations.

Protection Modes

Background The RMX-400x Series includes several protection modes: over current protection, over voltage protection, over power protection, under voltage protection, and constant power protection.

The protection modes are useful to protect both the load modules and the DUT(s). You can set a buzzer to notify when a protection setting is tripped. When a protection feature is activated and tripped, the load unit displays an alarm. The mainframe also displays an alarm. When an alarm is tripped, the load stops sinking current/voltage. There are three over load protection settings: on, off, and clear.

				Alarm
OCP Level		5.075 A		CH1
OCP Setting		OFF		CCDH
OVP Level		81.6 V		
OVP Setting				
OPP Level		W		80V
OPP Setting				Conf
Protection	Other	Go-NoGo		Previous Menu

Over Current Protection

When a load unit is operating in CR, CV, or CP mode, the unit may need over current protection to prevent excessive current being set. Over current protection stops the load from sinking more current than its recommended limit, which can damage the unit.

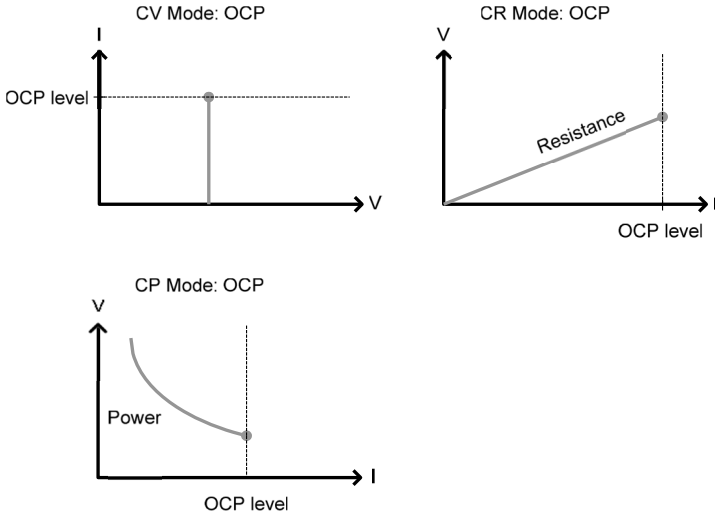

Over Voltage Protection

Over voltage protection limits the amount of voltage sunk. If the OVP trips, the RMX-400x series load stops sinking voltage.

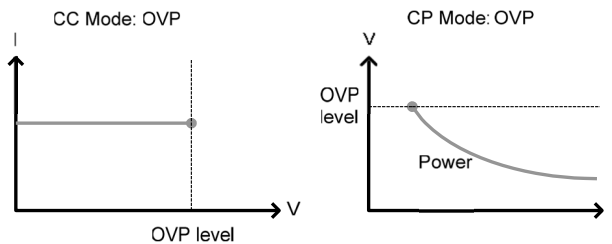

Over Power Protection	Use over power protection to limit the amount of power sunk. When OPP is tripped, power ceases to be sunk.
Reverse Voltage Protection	Reverse voltage protection prevents reverse voltage damage to the RMX-400x Series up to the specified rating. When reverse voltage protection is tripped, an alarm tone sounds until the reverse voltage is removed. Refer to the specifications for more details.
Under Voltage Protection	Under voltage protection turns off the load when the voltage drops below a set limit.
Constant Power Protection	Constant power protection prevents excessive power draw.

Operating Configurations

Background	There are operating configuration settings for the following: CC Vrange, Von Voltage, Von Latch, CH Cont, Independent, load D-Time, Response settings, Step resolution settings, and Short settings.
CC Vrange	Use CC Vrange (refer to page 201) to set the voltage range as high or low for CC mode. CC voltage range depends on the load module specifications.

Von Voltage

Von voltage is the voltage limit at which the load starts to sink current. There are two operation modes for Von voltage -- Von latched: on and Von latched: off.

Latched: off sinks current when Von is tripped, and continues to sink current even if the voltage drops below the Von voltage.

Von latched: off sinks current when Von is tripped, but stops sinking current when the voltage drops below the Von voltage setting.

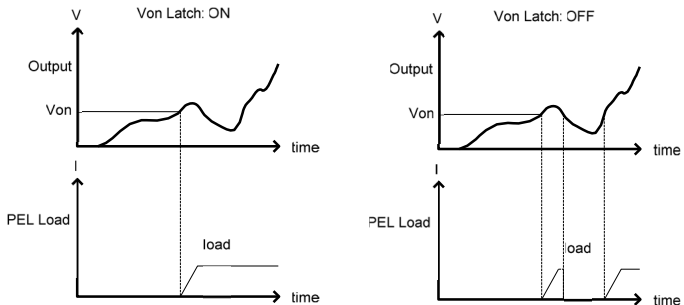

As shown below, when Von latch is set to off, the load module starts to sink current when the Von-voltage limit is tripped. It stops sinking current when the output drops below the Von voltage limit.

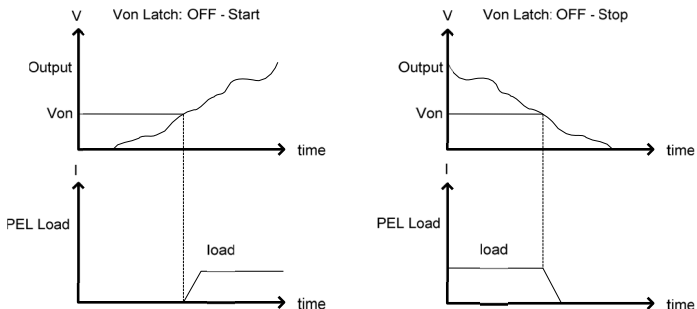

Short When short mode is on, the load unit can simulate a short circuit.

You can set shorting individually for each channel when programming sequences.

Use the short key to initiate a short circuit manually. You can use it at any time during an operation. It does not affect the settings. After a short circuit finishes, the load unit resumes the previous operation.

You can set the short key to toggle or hold. When pressed in toggle mode, shorts are toggled on and off. When pressed in hold mode, you need to hold the key to short the load.



Note

A short circuit may trip a protection mode if too much current is sunk.

CH CONT Channel Control. When channel control is activated (external), you can use it to monitor the load voltage and current output as well as turn loads on or off remotely from the channel control (CH CONT) connectors on the rear panel.

For more information about channel control, refer to external voltage control on page 100.

Independent Use the independent setting to control the load modules independently from the mainframe.

- Load D-Time** Use load delay time to delay activating a load (up to 10 seconds) after pressing the load key. However, the load delay time setting works for only loads initiated manually or when the RMX-400x series mainframe is configured to auto load (refer to page 226) at run time.
- Response** The Response setting sets the bandwidth of the load to 1 kHz (normal) or 100 kHz (fast). The Response setting is particularly important for limiting startup current.
- Step Resolution** For each channel, you can configure the step resolution for the current, resistance, voltage, and power setting. The step resolution refers to the *coarse adjustment* step resolution of these settings. You cannot configure the *fine adjustment*; refer to page 213 for details.

For example, if the step resolution for CCH (CC high range) is 0.5 A, you can increment the resolution in 0.5A steps:

$$8.0 \leftarrow \rightarrow 8.5 \leftarrow \rightarrow 9.0 \leftarrow \rightarrow 9.5$$

The step resolution parameters apply to the following:

CCH Step – CC high range

CCL Step – CC low range

CRH Step – CR high range

CRL Step – CR low range

CVH Step – CV high range

CVL Step – CV low range

CPH Step - CP high range

CPL Step - CP low range

Step Resolution Range The step resolution range depends on the load module and the range:

Max resolution: Module dependent

Min resolution: Module dependent

Short Key

When short mode is on, the load unit can simulate a short circuit.

You can set shorting individually for each channel when programming sequences.

Use the short key to initiate a short circuit manually. You can use it at any time during an operation. It will not affect the settings. After a short circuit has finished, the load unit resumes the previous operation.

You can set the short function ON or OFF. When set to ON, the short key is enabled. When set to OFF, the short key is disabled.

You can set the short key to toggle or hold. When you press the short key in toggle mode, shorts are toggled on and off. When you press the short key in hold mode, you must hold the key to short the load.

You can use the Short Safety to set the short operation mode. When set to ON, you must use the short function in the case of Load ON. When set to OFF, you can use the short function directly.

Channel Control

Background Use external channel control with the Channel Control connectors. Each channel control connector can activate each load, monitor voltage and current, and has an external voltage reference input. The voltage and current monitors output 0-100% of the rated current/voltage as a voltage of 0-10 V.

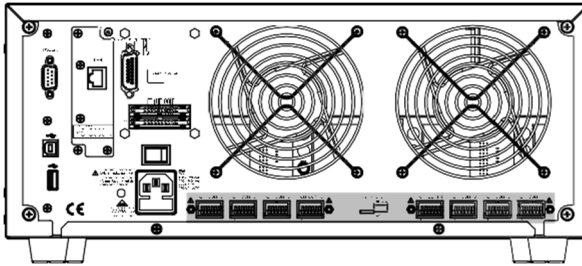

External Voltage Reference A voltage reference of 0-10 V represents 0-100% of a load module's rating voltage/current. As shown below, the external voltage reference and the rating voltage/current have a linear relationship. Varying the reference voltage between 0-10 V changes the voltage/current setting accordingly.

External Voltage Control

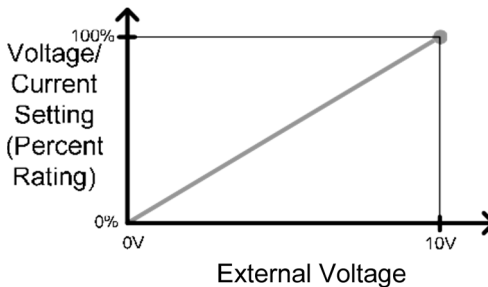

To determine the Percent Rating (voltage or current load input), use the following formula:

$$\text{Load Input} = \frac{\text{External Voltage}}{10(V)} \times \text{Rating } V \text{ or } A$$

where *Rating V or A* is the load module's rating voltage/current.

Current Monitor You can monitor the load current input externally using the IMON pin of a channel control connector. The IMON pin outputs a voltage of 0-10 V to represent the input current as a percentage (0-100%) of rating current.

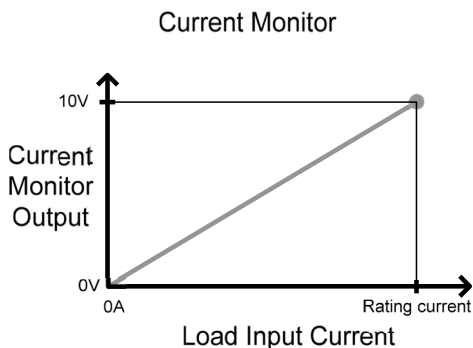

To determine the Current Monitor Output (IMON), use the following formula:

$$IMON = \frac{\text{Load input current}}{\text{Rating } A} \times 10V$$

where *Rating A* is the load module's rating current.

Voltage Monitor Like the load input current, you can monitor the input voltage externally with the channel control connectors. The channel control connector VMON pin outputs a voltage of 0-10 V to represent the load input voltage as a percentage (0-100%) of the rating voltage.

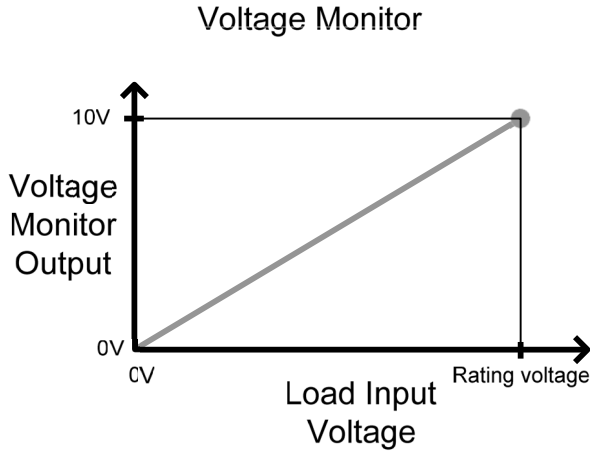

To determine the Voltage Monitor Output (VMON), use the following formula:

$$VMON = \frac{\text{Load input voltage}}{\text{Rating } V} \times 10V$$

where *Rating V* is the load module's rating voltage.

Turning On the Load To turn on a load, set the Load On input to On (active low). To turn off a load, set the Load On input to Off (active high).

When you turn on a load from the channel control interface, you can turn off the load from the mainframe, the local module, and via remote control. However, the opposite is not true; when you turn off a load using the channel control interface, you cannot turn on the load via the mainframe, the local module, or via remote control.

For connections and configurations, refer to pages 63 and 313, respectively.

Interface and System

Interface

Background The RMX-400x series supports RS232, LAN, and USB remote frame control. The series supports only one type of connection at any one time. For more information about remote control, refer to the National Instruments website at ni.com or contact your local distributor about the RMX-400x series programming manual.

For connection options and configurations, refer to the following options.

RS-232 configuration	Page 251
RS-232 pin connection	Page 312
USB configuration	Page 253
Configuring Ethernet connection	Page 253

File System

Background The RMX series can save and recall several data types for each channel:

- Presets
- Memory
- Setup
- SEQ (Sequence)

You can save and recall all data types to internal memory or save them to a USB flash drive. Each channel has its own dedicated memory for each data type. Thus, you can save and recall files for

each channel and data type.

Preset Data You can save preset data into 10 memory slots for each channel. Preset data contains the mode, range, CV response speed, and Go/NoGo settings.

Internal Format	P0-P9
External Format	400X_XX.P

Preset Contents Preset data contains the following data:

CHAN	• Mode	• Static/dynamic
	• Range	• CV response speed
Go/NoGo	• SPEC test	• Entry mode
	• High	• Low
	• Center	

Memory Data Each channel can save up to 120 different Memory data types (M001-M120) into internal memory. Memory data contains general channel settings, and you use it when programming sequences. You can store memory data both internally and externally to USB. Preset data and Memory data store the same contents.

Internal Format	M001-M120
External Format	400X_XX.M

Memory Contents Memory data contains the following data:

CHAN	• Mode	• Static/dynamic
	• Range	• CV response speed
Go/NoGo	• SPEC test	• Entry mode
	• High	• Low
	• Center	

SEQ Data	SEQ data contains Sequence data. You can save SEQ data only to and from USB. SEQ refers to Sequence data, not Program sequences.	
Internal format	N/A (Internal buffer)	
External format	400X_XX.A	

SEQ Contents	SEQ data contains the following data:		
Seq.Edit	<ul style="list-style-type: none"> • No. (Points) • Slew rate f • Duration time 	<ul style="list-style-type: none"> • Value • Slew rate \downarrow 	
Loop	<ul style="list-style-type: none"> • Repeat • On end load 	<ul style="list-style-type: none"> • Start of loop • CC Vrange 	

Setup Data	You can save setup data to four internal memory slots. Setup data contains memory data, program sequence, chain data, configuration settings, and operation settings for every channel. You can save setup data to internal memory or USB.	
Internal format	Setup memory 1-4	
External format	400X_XX.S	

Setup Contents	Setup data contains the following data:		
Program	<ul style="list-style-type: none"> • PROG • Memory • On-time • P/F-time • Short channel 	<ul style="list-style-type: none"> • SEQ (program sequence number) • Run • Off-time • Short-time 	
Chain	<ul style="list-style-type: none"> • Start 	<ul style="list-style-type: none"> • Program sequence (P01-P12) 	

Run	• Active channel (CH01-08)	
CHAN	• Mode	• Static/dynamic
	• Range	• CV response speed
Go/NoGo	• SPEC test	• Entry mode
	• High	• Low
	• Center	

Save: Internal Memory When saving data to internal memory, you can save either the current channel or all channel data. Not all data types can save the current channel or all channel data.

Data type	Current channel	All channels
Preset	✓	✓
Memory	✓	✓
SEQ	✓ (Single save)	—
Setup	—	✓

Save: External Memory You can save only SEQ, memory, and preset data for a single channel to USB. All four data types (SEQ, memory, setup, preset) can save all channels to USB.

Data type	Current channel	All channels
Preset	✓	✓
Memory	✓	✓
SEQ	✓	✓
Setup	—	✓

Save/Recall USB To save data from a single channel to USB, you first must save data to the internal memory. After you save data to internal memory, you can save all the files to USB.

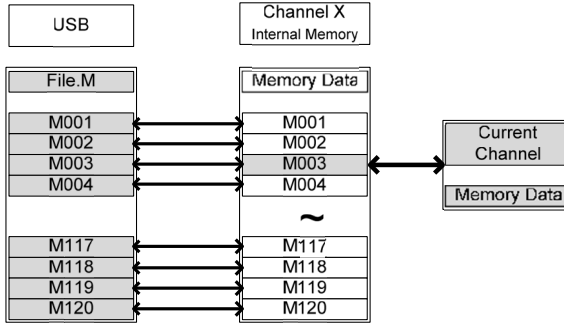

To recall saved files, the reverse is also true. You must recall files from the USB flash drive to internal memory. Then from internal memory, you can recall the data to each channel (excluding SEQ data).

Save/Recall All You can save the SEQ, preset, memory, or setup data from every channel into USB. SEQ, preset, and memory data is saved to a directory (ALL0000-ALL0099) with a file for each channel, while setup data is saved in a single file.

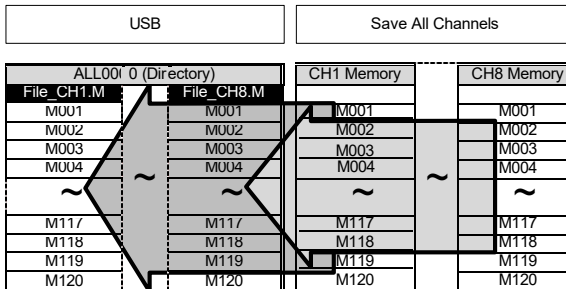

To recall saved files, the reverse is not true. You must recall files to each channel separately.

File Format

Current Channel Filename Format

Memory data **4003R_00.M**
 Preset data 
 SEQ data

1: RMX-400x load module type:

4003 = RMX-4003

4004 = RMX-4004

4005 = RMX-4005

4006 = RMX-4006

2: Channel location or voltage range of single channel model:

R = Right

L = Left or single channel low voltage model

H = High voltage model

3: Save file number:

0-99

Incremented after each consecutive save.

4: File extension

M = Memory data

P = Preset data

A = SEQ data

All Channel Directory Format

ALL0000

1: All Channel common directory name

2: Directory number:

0000 - 0099

All Channel

Filename Format

Memory data
Preset data
SEQ data
Setup Data

4003R_C1.M

4003R_C1.M

1: RMX-400x load module type:

4003 = RMX-4003

4004 = RMX-4004

4005 = RMX-4005

4006 = RMX-4006

4000 = RMX-4000

4002 = RMX-4002

2: Channel, voltage range of single channel model or mainframe indication

R = Right

L = Left or single channel low voltage model

H = Single channel high voltage model

F = Mainframe

3: Channel number:

C₁ = CH₁

C₂ = CH₂

Etc.

oo = All channels (setup data)

4: File extension

M = Memory data

P = Preset data

A = SEQ data

S = Setup data

TUTORIALS

Step-by-Step Operations

Local Loads	113
Single Channel Load	115
Parallel Load Modules	117
Programming	119
Sequences.....	121
Frame Link.....	122
Channel Control.....	124
General Configuration Options.....	126

Local Loads

Local mode operation is useful for quickly testing loads using the load module control panel rather than the mainframe control panel. You can configure local load modules to operate independently to the mainframe. This can be useful when settings need to remain unchanged on the mainframe. However, note that the local modules cannot change the modes (CC, CV, CR, CP); the modules can change only the values.

Group Unit mode is not supported for local module control.

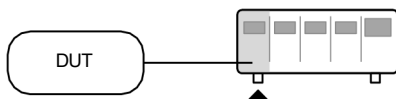

Step	Description	Details
1. Setup	Ensure that the channel load is set up as desired.	Pages 42 and 49
2. Channel selection	Ensure that the correct channel or Value (A/B) is selected by using the R/L or A/B key.	Page 130
3. Measurement mode selection	If in CC or CR mode, you can select static or dynamic mode.	CC Pages 131 and 143 CR Pages 149 and 151
4. Run the load	Press the LOAD key to start/end loading the device under test.	Page 132

Optional

5. Short configuration	Configure the SHORT settings.	Page 133
6. Display	To change the display output, use the DISPLAY key.	Page 133
7. Shorting the load	To short the load, use the SHORT key.	Page 133

8.	Independent load	You can set the local load modules to independent load.	Page 209
9.	Independent control	You can configure slave knobs to be independent from the mainframe.	Page 233
10.	Configure slave knob settings	Display measured or set values with the selector knob.	Page 237

Single Channel Load

Use single-channel loads to manually test a DUT quickly or to configure channel settings for program sequences using the mainframe panel.

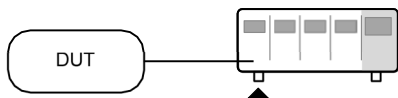

Step	Description	Details
1. Setup	Choose the appropriate load module and make sure it is installed.	Page 42
2. Connection	Connect the terminals to the DUT.	Page 49
3. Channel selection	Select the load channel on the mainframe.	Page 136
4. Measurement mode selection	Select measurement mode (CC, CV, CR, or CP mode).	CC Page 139 CV Page 154 CR Page 144 CP Page 160
5. Range selection	Set the range to high or low (CC, CR, CV, and CP mode).	CC Page 140 CR Page 147 CP Page 164
6. Mode selection	Choose static or dynamic mode (CC and CR mode only).	CC Pages 141 and 143 CR Pages 149 and 151
7. Dynamic levels (CC and CR)	Set the dynamic levels, slew rate, and timers (CC and CR mode only).	CC Page 141 CR Page 149
8. Static Values (CC, CR, CV, and CP)	Set the A (B) Value, slew rate (CC, CR) and current limit (CV, CP).	CC Page 144 CR Page 152 CV Page 155 CP Page 161

9. Go/NoGo Set the Go/NoGo configurations, if applicable. Page 217

10. Protection modes Configure the protection modes. Page 197

11. Run Activate the load by pressing the load key.



Optional

12. Configuration There are number of configurations that apply to all channels. For details refer to the Configuration Tutorial. Page 126

Parallel Load Modules

Use the Group Unit setting for quick and easy parallel setup for load modules of the same type and rating. (The Group Unit settings apply to only CC and CR modes.)

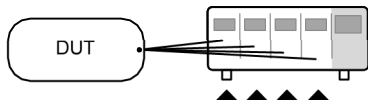

Step	Description	Details
1. Setup	Choose the appropriate load modules and make sure they are installed. All load modules must be of the same type and rating.	Page 42
2. Connection	Connect the terminals to the DUT.	Page 49
3. Group Unit mode configuration	Enable Group Unit mode and configure.	Page 221
4. Measurement mode selection	Select measurement mode (CC and CR mode).	CC Page 139 CR Page 144
5. Range selection	Set the range to high or low (CC and CR mode).	CC Page 140 CR Page 147
6. Mode selection	Choose static or dynamic mode.	CC Pages 141 and 143 CR Pages 149 and 151
7. Dynamic levels	For dynamic mode, set the dynamic levels, slew rate, and timers.	CC Page 141 CR Page 149
8. Static values	For static mode, set the A(B) Value and slew rate.	CC Page 144 CR Page 152

9. Go/NoGo Set the Go/NoGo configurations, if applicable. Page 217

10. Protection Modes Configure the protection modes. Page 197

11. Run Activate the load by pressing the load key.



Optional

12. Configuration There are number of configurations that apply to all channels. For details, refer to the configuration tutorial. Page 126

Programming

When you create a program sequence or chain, all channels are used at the same time unless programmed otherwise. Program sequences use the channel settings stored from memory data. Program sequences primarily perform a battery of pass/fail tests on DUTs.

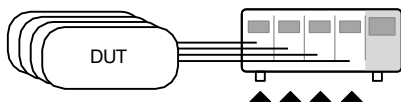

Step	Description	Details
1. Setup	Choose the appropriate load module(s).	Page 42
2. Connection	Connect the terminals to the DUT.	Page 49
3. Channel selection	Select the load channel(s) on the mainframe.	Page 136
4. Channel setup	Refer to the single-channel load tutorial to configure a single channel. Do not activate the load.	Page 115
5. Save channel	Save the configured channel.	Page 257
6. Multiple channels	If you need to configure multiple channels, follow steps 1-5 for any remaining channels.	
7. Program menu	Enter the Program menu.	Page 160
8. Configure the sequence	Configure the program.	
9. Save sequences	Save the program in the FUNC →Program menu.	
10. Program chains	You can create program chains if required.	Page 171

- 11. Save Program Save the chain in the Chain menu.
- 12. Save Setup Save everything to the internal setup memory. Page 276
- 13. Run Run the program sequence/chain. Page 173

Sequences

Use sequences to accurately simulate loads. As each sequence is independent, sequences are ideally suited to test multiple output power sources.

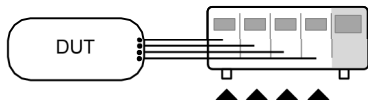

Step	Description	Details
1. Setup	Choose the appropriate load module(s).	Page 42
2. Connection	Connect the terminals to the DUT.	Page 49
3. Channel selection	Select a load channel with the mainframe.	Page 136
4. Channel setup	Create a sequence.	Page 179
5. Sequence loop	Create a sequence loop if necessary.	Page 181
6. Multiple channels	If you need to configure multiple channels, follow steps 1-5 for any remaining channels.	
7. Channel Duration menu	Edit the sequence channel duration information. Ensure that the channels containing sequences are not set to OFF.	Page 184
8. Trigger settings	Set trigger out and in channels, if appropriate.	
9. Run	Run the sequence(s)	Page 186

Frame Link

Use frame link connections to connect up to four slave main frames to a master main frame. When using frame link connections, you can perform several operations in parallel under the master unit's control.

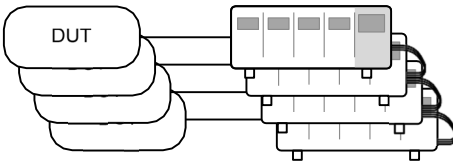

Step	Description	Details
1. Setup	Connect the mainframes.	Page 61
2. Configure	Configure the frame CONT to ON for all mainframes.	Page 231



At first, both the master and slaves are independent. You can see FRM (frame master) on the top panel of each mainframe. When a mainframe is connected as a slave unit, the FRM icon changes to FRS (frame slave). The front panel keys are disabled on slave units when in slave mode (FRS).

Slave mode **FRM** → **FRS**

Master/independent **FRM**

3. Program	Refer to the tutorial sections for programming or channel configuration.	Pages 115 and 117
------------	--	-------------------

4. Run Run the loads. To run the loads, press the LOAD key on the master mainframe. To stop, press again. When the LOAD key is pressed, all loads are active.

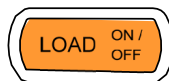

Options

5. Load preset memory Load preset memory on the mainframe and all frame-linked slaves. Page 306

6. Load setup memory Load setup memory on the mainframe and all frame-linked slaves. Page 305

7. Set slave to independent Press shift + CHAN on the slave unit to enable local control on a slave unit.

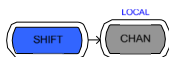

FRS → **FRM**



Note

When a load is run or memory is recalled from the master mainframe, the slave unit returns to mainframe control.

Ensure that the same firmware is installed on both master and slave mainframes.

Channel Control

Use the Channel Control connectors on the rear panel to control and monitor the status of up to eight channels. For more information about channel control, refer to page 100.

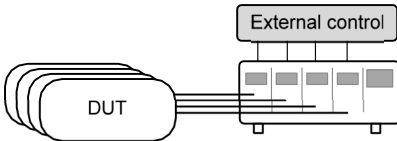

Step	Description	Details
1. Setup	Ensure that the load and RMX series mainframe is turned off.	
2.	Choose the appropriate load module(s).	Page 42
3. Connection	Connect the terminals to the DUT.	Page 49
4.	Connect the channel control connectors on the rear panel.	Page 63 and 313
5.	Turn on the RMX series mainframe and DUT (load).	
6. Configure	Select the mode* and range* via the front panel.	CC Pages 139 and 140 CV Page 154
7.	Activate channel control for each channel used for external control (that is, set CH CONT to External).	Page 208
8. Run	Run the load. Turn the load on by either outputting an active low signal to the appropriate channel control connector or pressing the LOAD key on the load module or mainframe**.	Page 63 and 100

9. Monitor Use IMON and VMON to monitor Page 100
the current and voltage of load
outputs.

10. End To turn the load off, output an
active high signal to the channel
control connector or press the
LOAD key on the load module or
mainframe**.

*You cannot configure mode and range via the channel control (CH CONT) interface. You can configure mode and range only via the front panel.

**You cannot always use the LOAD key to turn on/off the load. Refer to page 100 for details.

General Configuration Options

Each channel has several options, which are described below.

Options	Description	Details
1. CCVrange	Configure the CC voltage range from high or low.	Page 201
2. Von voltage	Configure the Von voltage settings.	Page 203
3. Short settings	Configure the short key settings.	Page 205
4. CH CONT	Turn channel control on/off.	Page 208
5. Independent load	Turn the load module control to dependent (via mainframe) or independent control.	Page 209
6. Delay time	Configure the load delay time for each channel (0-10 seconds).	Page 211
7. Clear all protection	Clear all the protection alarms.	Page 200
8. Display	Adjust display settings.	Page 228
9. Control type	Configure the knob control.	Page 233
10. Slave knob setting	Display measured or set values with the selector knob.	Page 237
11. Alarm	Configure alarm settings.	Page 234
12. Step resolution	Configure the step resolution (CC high and low range, CR high and low range, CV high and low range, and CP high and low range).	Page 213
13. Response	Configure the response setting.	Page 217
14. Sound	Turn the sound on/off for the mainframe IU.	Page 228

O PERATION

The following chapters describe RMX series operation. The sections are divided into small operations. For detailed electronic load operation examples, refer to the tutorial section on page 113.

Local Mode Operation.....	130
Selecting a Channel.....	130
Selecting Static/Dynamic	131
Turning On the Load	132
Shorting.....	133
Display Output View	133
Editing CC/CR/CV/CP A/B Value.....	135
Mainframe Basic Operation.....	136
Help Menu	136
Channel Selection	137
Select CC Mode.....	139
Select CC Range.....	140
Select CC Dynamic Mode	141
Editing CC Dynamic Parameters.....	141
Select CC Static Mode	143
Editing CC Static Parameters	144
Set to CR Mode	146
Select CR Range.....	147
Select CR Dynamic Mode	149
Editing CR Dynamic Parameters.....	149
Select CR Static Mode	151
Editing CR Static Parameters	152
Select CV Mode.....	154
Editing CV Parameters	155
Select CV Range.....	158
Select CV Response Speed	159
Select CP Mode.....	160
Editing CP Parameters	161

Select CP Range	164
Creating a Program Sequence	165
Program Chains	171
Running a Program.....	173
Edit Sequence	179
Create Sequence Loop.....	182
Channel Duration Time Settings	184
Run Sequence.....	186
OCP Test Automation.....	189
Channel Configuration.....	196
Accessing the Configuration Menu.....	196
Setting OCP/OVP/OPP/UVP	197
Protection Clear.....	200
Setting the CC Voltage Range.....	201
Adjusting the Von Voltage and Latch	203
Configuring the Short Settings.....	205
Configuring Channel Control.....	208
Configuring the Independent Setting	209
Configuring the Load Delay Time.....	211
Configuring Step Resolution	213
Configuring Response Time	217
Go/NoGo	219
Group Unit.....	221
Mainframe Configuration	225
Accessing System Information.....	225
Accessing the Load Menu	226
Adjusting the Speaker	228
Adjusting the Display Settings	229
Adjusting the Frame Control.....	231
Adjusting the Knob Control Type	233
Configuring Alarm Sound	234
Configuring Go/NoGo Alarm Sound	235
Adjusting Slave Knob Settings	237
View Language Settings	239
Adjusting the High Resolution.....	240
Adjusting the System Mode	242
Adjusting the Von Latch Clear.....	244
Adjusting the Measure Period.....	246

Adjusting the Jog Shuttle Control	247
Adjusting the RVP Load Off.....	248
Setting the Date and Time	250
Interface Configuration (Settings).....	251
Configuring RS232 Connection.....	251
Configuring USB Connection.....	253
Configuring Ethernet Connection	257
Web Server Function Check.....	260
RS232 and USB CDC Function Check	263
Socket Server Function Check	266
Saving/Recalling Channels	271
Saving/Recalling Preset memory.....	274
Saving/Recalling Setup Memory.....	276
Setting the Default USB Path/File.....	278
Saving Setups to USB Memory.....	283
Saving/Recalling Memory Data to USB.....	286
Saving/Recalling Presets to USB.....	292
Saving/Recalling Sequences to USB.....	298
Quick Preset Recall/Save.....	304
Recall Setup Memory (Frame Link).....	305
Recall Preset Memory (Frame Link).....	306
Recall Factory/User's Defaults	307

Local Mode Operation

Local load modules can edit each channel. Depending on the configuration, the mainframe can reflect local changes. In this section, all operations refer to knobs and buttons on the local load module panels, unless stated otherwise.

Selecting a Channel

Background You can select each channel individually by using its load module panel. Changing channels on a load module applies only to dual-channel load modules.

Single Channel Panel Operation Press any key on a load module to select its channel.

Dual Channel Panel Operation For dual-channel load modules, press any key on a load module that has the desired channel. Press the R/L key to cycle between the channels on the load module. L or R is displayed on the bottom left hand to indicate which channel (left or right side) is active on the load module.



LR



Note

On single channel modules, pressing the A/B key repeatedly changes the level from A or B when in static mode.

You cannot select channels in Group Unit mode.

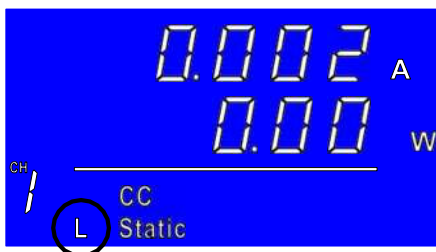

Selecting Static/Dynamic

Background You can switch each load channel individually from static to dynamic using the local load module.

1. Select a channel on the load module. Page 130

Panel Operation 2. Press the STATIC/DYNA. key to switch from dynamic to static mode and vice versa.



Note

All changes are shown on the display and, depending on the configuration, reflected on the mainframe.

You cannot select static/dynamic in parallel mode.

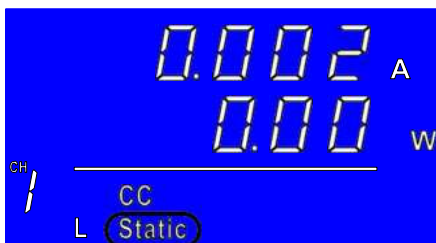

Turning On the Load

Background Use local operation to select loads individually to be turned on.

1. Select a channel on the load module. Page 130

Panel Operation 2. Press the LOAD key to turn on the load.



Note

When you activate a channel load, the load on symbol appears under the channel number.

Range

L-ON Left channel

R-ON Right channel

ON Single channel

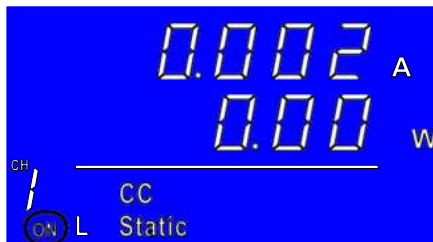

Turning the load off 3. Press the LOAD key.



Shorting

- | | | |
|-----------------|--|----------|
| Background | You can set the short key to simulate a short circuit. | |
| | 1. Configure the short settings. | Page 130 |
| | 2. Select a channel on the load module. | Page 130 |
| Panel Operation | 3. Press the SHORT key to enter the shorting modes. | |

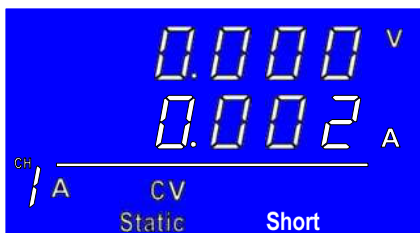

- | | | |
|----------|--|--|
| Shorting | 4. a. Press the SHORT key (toggle mode). | |
| | or | |
| | b. Hold the SHORT key (hold mode). | |



Note

You cannot short the load from the local load module in Group Unit mode.

Display Output View

- | | |
|------------|--|
| Background | Use the DISPLAY key to switch the display output to different views. |
|------------|--|

- Panel Operation 1. Press the DISPLAY key repeatedly to switch between the different views.



- V** Voltage
- A** Current
- W** Power
- S** Load on time



Note

You cannot change the display mode in Group Unit mode.

Editing CC/CR/CV/CP A/B Value

Background Use the slave knob to edit the A Value or B Value (single-channel load module) when in static mode. The slave knob also can operate in fine or coarse editing mode.

Panel operation 1. Ensure that the mode is in static mode. Page 131

2. Choose a channel (or choose A or B Value) by pressing the R/L or A/B key.



3. Press the slave knob to toggle between fine and coarse editing mode.

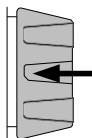

SEt_C = coarse mode.

SEt_F = fine mode.

Fine mode example:



Coarse mode example:



4. Turn the slave knob to edit the A/B Value for the selected mode.

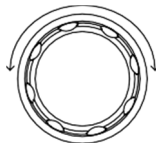

Note

When the slave knob is set to Measure, you must press the slave knob first to display the values on the load module display.

You cannot edit the A/B Value using this method in Group Unit mode.

Mainframe Basic Operation

In this section, all operations refer to the knobs and keys on the main configuration panel, unless otherwise stated.

Help Menu

Background When you press any function key or open a menu, use the HELP key to display a detailed description.

1. Press a function or system key on the front panel or open a menu.

Help Selection 2. Press the HELP key to display the built-in help. A description of the function or menu item appears, as shown below.

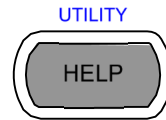

3. Use the scroll wheel to scroll down if necessary. A

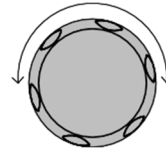

File System

The system is able to save and recall a number of different data types for each channel: **Memory**, **Preset**, **Sequence** And, a data type for all channels is **Setup**.

All data types can be saved and recalled to internal memory or saved to a external

Help On Help					Exit
-----------------	--	--	--	--	------

4. Press F5 to exit.



Channel Selection

Background There are up to two channels per load module, depending on the model. Use the main display to control each channel individually.



Note

When Group Unit mode is enabled, channel selection is disabled.

Mainframe Channel Selection

1. Press the CHAN button.



2. Select a channel by turning the variable knob.

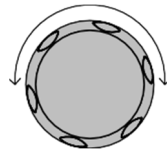

The channel selection appears highlighted in orange on the top right of the screen.

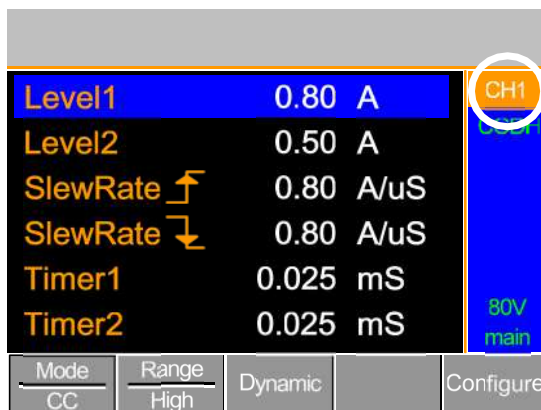

3. Press the selector knob or Enter to confirm.

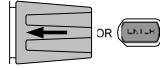

Select CC Mode

Background The RMX-400x series loads operate in four different modes: constant current (CC), constant resistance (CR), constant voltage (CV), and constant power (CP).

When a channel is active, use the F1 key to switch between operating modes.

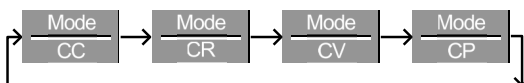

- Panel Operation**
1. Select a channel using the CHAN button and selector knob.
 2. Press F1 repeatedly until CC mode is displayed in the display panel.

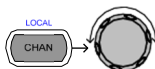

Mode	Range	Dynamic		Configure
CC	High			



Note

Changing the operating mode affects only the current (active) channel. Changes do not affect other channels.

Select CC Range

Background

Constant current mode can run in high and low range. Maximum range depends on the load module. Some models are only high range.

Ensure that the menu is in CC mode. Refer to page 139.

Mode	Range	Dynamic		Configure
CC	High			

Panel Operation

1. Press the F2 (range) key repeatedly until high or low range is selected.

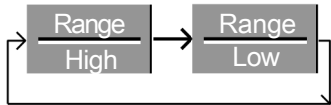

The range is reflected in both the bottom menu system and the Current Operation Channel Status panel.

CC dynamic low	CCDL
CC dynamic high	CCDH
CC static low	CCL
CC static high	CCH



Note

Changing the range affects only the current (active) channel. Changes do not affect other channels.

Not all load modules support dual ranges. If only one range is supported, it is usually high range.

Select CC Dynamic Mode

Background You can set constant current mode to dynamic or static mode. Use dynamic mode to set varying load rates automatically.

Ensure that the menu is in CC mode. Refer to page 139.

Mode	Range	Dynamic		Configure
CC	High			

Panel Operation 1. Press the F3 key until dynamic range mode is selected.

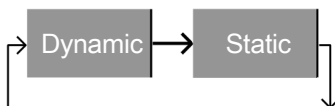

Note

Changing from static to dynamic mode affects only the current (active) channel.

Editing CC Dynamic Parameters

Background Dynamic constant current mode has two operating current levels: slew rates and timers.

Slew rates determine the speed at which the load changes from one level to the next.

The timers determine how long the load module/channel stays at level 1 or level 2.

Ensure that the menu is in CC dynamic mode. Refer to page 141.

Mode	Range	Dynamic		Configure
CC	High			

Parameters	Level1	0 - Setting Max A
	Level2	0 - Setting Max A
	SlewRate	↕ Load module dependent
	SlewRate	↘
	Timer1	0.025-30000.0 ms
	Timer2	0.025-30000.0 ms



Note

In Group Unit mode, the Level1 and Level2 range is the combined rating of all units used in Group Unit mode.

- Panel Operation
1. Use the selector knob to highlight Level1.

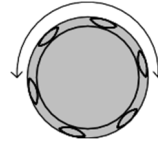

Level1			0.80 A	CH1P
Level2			0.50 A	CCDH
SlewRate ↕			0.80 A/uS	
SlewRate ↘			0.80 A/uS	
Timer1			0.025 mS	
Timer2			0.025 mS	80V main
Mode	Range	Dynamic		Configure
CC	High			

- Press the selector knob to edit the selected level, then turn to increase or decrease the value*.

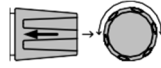

or

Use the number pad to enter a number.



Level1

0.80

A

- Press the selector knob or Enter to confirm the selection.
- Repeat steps 1-3 for the remaining parameters.



Note

You can set Level1 and Level2 for both high and low range.

*Press Shift to toggle between coarse and fine adjustment when editing the Level1 and Level2 parameters. Refer to page 213 for details.

Select CC Static Mode

Background

You can set constant current mode to dynamic or static mode. Static mode is for manually varying the load for single-channel load modules or setting a static load on dual-channel modules.

Ensure that the menu is in CC mode. Refer to page 138.

Mode	Range	Dynamic		Configure
CC	High			

- Panel Operation 1. Press the F3 key until static mode is selected.

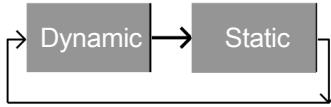

Note

Changing from static to dynamic mode affects only the current (active) channel.

Editing CC Static Parameters

CC Values

When using a single channel load module, Static Constant Current mode has two operating current values, A and B. If a dual channel load is used, only one current value is available per channel: A Value.

If Group Unit mode is enabled, an additional parameter, Switch Value, is available to switch from A Value to B Value.

Ensure the menu is in CC Static mode. Refer to page 143.

Mode	Range	Static	Seq.	Configure
CC	High		Edit	

Parameters	A Value	0 - Setting Max A
	B Value	0 - Setting Max A
	SlewRate	↕ Load module dependent
	SlewRate	↘
	Switch Value	A/B (Group Unit mode only)



Note

When Group Unit mode is enabled, the A Value and B Value range is the combined rating of all the units used in Group Unit mode. Refer to page 80.

- Panel Operat ion
1. Use the Selector knob to highlight A Value.

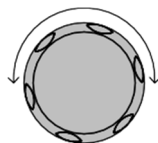

Single Channel Configur ation



Group Unit Mode Configur ation

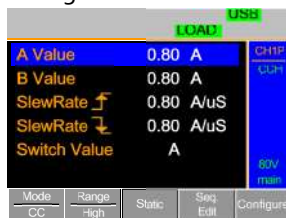

2. Press the Selector knob to edit the selected value, then turn to increase or decrease the value*.

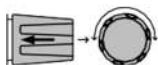

OR

Use the number pad to enter a number.

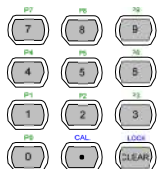

A Value

0.80

A

3. Press the selector knob or Enter to confirm selection.

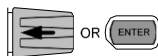

- Repeat steps 1-3 for the remaining parameters.



Note

The last value (A Value or B Value) set becomes the active setting. To switch between A Value and B Value, use the A/B keys on the local load module. This is not applicable to Group Unit mode.

For Group Unit mode, use the Switch Value parameter to switch between A and B Value.

You can set A/B Value and rising/falling Slew Rate for both High and Low Range.

*Press Shift to toggle between coarse and fine adjustment when editing the A Value and B Value parameters. Refer to page 213 for details.

Set to CR Mode

Background

The RMX-400x Series load operates in four different modes, constant current (CC), constant voltage (CV), constant resistance (CR) and constant power (CP). Constant resistance mode maintains a constant resistive load, using variable current and voltage levels.

When a channel is active, use the F1 key to switch between each operating mode.

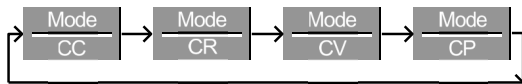

Panel Operation

- Press the CHAN button and use the selector knob to select a channel.

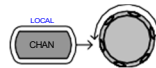

- Press F1 until CR mode is displayed in the display panel.



Mode	Range	Dynamic		Configure
CR	Low			



Note

Changing the operating mode affects only the current (active) channel. Changes do not affect other channels.

Select CR Range

Background Constant resistance mode can run in high and low range. Range is dependent on the load module.

Ensure that the menu is in CR mode. Refer to page 144.

Mode	Range	Dynamic		Configure
CR	Low			

- Panel Operation**
1. Press the F2 (Range) key repeatedly until high or low range is selected.

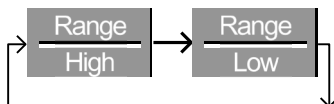

The range is reflected in both the bottom menu system and current operation channel status panel.

CR Static Low	CRL
CR Static High	CRH
CR Dynamic Low	CRDL
CR Dynamic High	CRDH





Changing the range affects only the current (active) channel. Changes do not affect other channels.

All resistance values and slew rates depend on range (that is, A Value in low range can be different from A Value in high range).

Select CR Dynamic Mode

Background You can set constant resistance mode to dynamic or static mode. Use dynamic mode to set varying load rates automatically.

Ensure that the menu is in CR mode. Refer to page 144.



Panel Operation 1. Press F3 until dynamic range mode is selected.

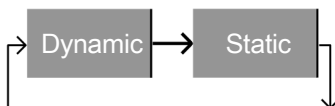

Changing from static to dynamic mode affects only the current (active) channel.

Editing CR Dynamic Parameters

CR levels Dynamic constant resistance mode has two operating resistance levels: slew rates and timers.

Slew rates determine the speed at which the load changes from one level to the next.

The timers determine how long the load module/channel stays at level 1 or level 2. Refer to the CR operating description on page 72 for details about slew rates and timers.

Ensure that the menu is in CR dynamic mode.
Refer to page 149.

Mode	Range	Dynamic		Configure
CR	Low			

Parameters	Level1	Minimum- rating Ω
	Level2	Minimum- rating Ω
	SlewRate \uparrow	Load module dependent
	SlewRate \downarrow	
	Timer1	0.025-30000.0 ms
	Timer2	0.025-0000.0 ms



Note

In Group Unit mode, the Level1 and Level2 range is the combined rating of all units used in Group Unit mode.

- Panel Operat ion 1. Use the selector knob to highlight Level1.

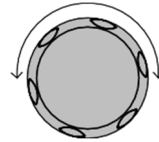

Level1			100.000 Ω	CH1 CRDL 80V main
Level2			100.000 Ω	
SlewRate \uparrow			0.40 A/uS	
SlewRate \downarrow			0.40 A/uS	
Timer1			0.025 mS	
Timer2			0.025 mS	
Mode	Range	Dynamic		Configure
CR	Low			

- Press the selector knob to edit the selected level, then turn to increase or decrease the value*.

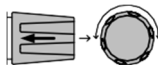

or

Use the number pad to enter a number.



Level1 100.000 Ω

- Press the selector knob or Enter to confirm the selection.
- Repeat steps 1-3 for the remaining parameters.

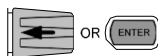

Note

You can set Level1 and Level2 for both high and low range.

*Press Shift to toggle between coarse and fine adjustment when editing the Level1 and Level2 parameters. Refer to page 213 for details.

Select CR Static Mode

Background

You can set constant resistance mode to dynamic or static mode. Static mode is for manually varying the load for single-channel load modules or setting a static load on dual-channel modules.

Ensure that the menu is in CR mode. Refer to page 144.

Mode	Range	Dynamic		Configure
CR	Low			

- Panel Operat ion 1. Press the F3 key until static mode is selected.

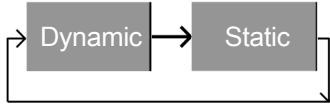

Note

Changing from static to dynamic mode affects the current (act ive) channel.

Editing CR Static Parameters

Background Single-channel load modules have two resistance levels, A Value and B Value. Dual-channel load modules have only one resistance level per channel, A Value.

When Group Unit mode is enabled, an additional parameter, switch value, is available to switch from A Value to B Value.

Ensure that the menu is in CR static mode. Refer to page 151.

Mode	Range	Static	Seq. Edit	Configure
CR	Low			

Parameters	A Value	Setting Min - Rating Ω
	B Value	Setting Min - Rating Ω
	SlewRate	Load module dependent
	SlewRate	
	Switch Value	A/B (Group Unit mode only)



Note

When Group Unit mode is enabled, the A Value and B Value range is the combined rating of all units used in Group Unit mode.

- Panel Operation 1. Use the selector knob to highlight A Value.

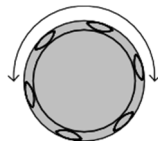

Single Channel Configuration

LOAD		USB
A Value	100.000 Ω	CH1 CAL
B Value	100.000 Ω	
SlewRate ↑	0.40 A/uS	
SlewRate ↓	0.40 A/uS	
		SEL INSTR
Mode	Range	Static
CR	Low	Seq. Edit
Configure		

Group Unit Mode Configuration

LOAD		USB
A Value	100.000 Ω	CH1P CAL
B Value	100.000 Ω	
SlewRate ↑	0.40 A/uS	
SlewRate ↓	0.40 A/uS	
Switch Value	A	
		SEL INSTR
Mode	Range	Static
CR	Low	Seq. Edit
Configure		

2. Press the selector knob to edit A Value / B Value, then turn to increase or decrease the value*.

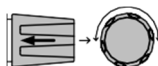

or

Use the number pad to enter a number.

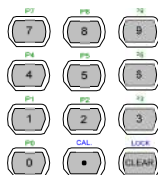

A Value 100.000 Ω

3. Press the selector knob or Enter to confirm the selection.



4. Repeat steps 1-3 for B Value (if applicable) and rising and falling SlewRate.

Note

The last Value (A Value or B Value) you set becomes the active setting. To swap between A Value and B Value, use the A/B keys on the local load module (not applicable to Group Unit mode).

For Group Unit mode, use the switch value parameter to switch between A and B Value.

You can set A/B Value and rising/falling SlewRate for both high and low range.

*Press Shift to toggle between coarse and fine adjustment when editing the A Value and B Value parameters. Refer to page 213 for details.

Select CV Mode

Background

The RMX-400x Series electronic load operates in four different modes, constant current (CC), constant resistance (CR), constant voltage (CV), and constant power (CP).

You cannot use CV mode with the Group Unit mode.

When a channel is active, you can use the F1 key to switch between each operating mode.

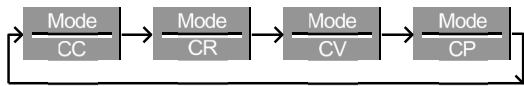

Panel Operation

1. Press the CHAN button and use the selector knob to select a channel.

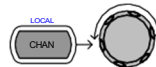

2. Press F1 until CV mode is displayed in the display panel.



Mode	Range	Response		Configure
CV	High	Slow		



Changing the operating mode affects only the current (active) channel. Changes do not affect other channels.

CV mode only operates in high range.

Editing CV Parameters

Background Constant voltage mode can be set to a maximum limit (Curr Limit). Using the current limit enables limiting the current draw.

When using CV mode on single-channel load modules, you can set two voltage levels, A Value and B Value. On a dual-channel load module, you can set only one voltage level per channel: A Value.

Ensure that the menu is in CV mode. Refer to page 154.

Mode	Range	Response		Configure
CV	High	Slow		

Parameters	A Value	0 - Setting Max V
	B Value	0 - Setting Max V
	Curr Limit	Load module dependent

Panel Operation 1. Use the selector knob to highlight A Value.

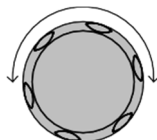



2. Press the selector knob to edit the selected value, then turn to increase or decrease the value*.

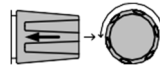

or

Use the number pad to enter a number.

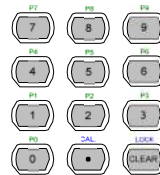

A Value 10.00 **V**

3. Press the selector knob or Enter to confirm the selection.
4. Repeat steps 1-3 for the remaining parameters.

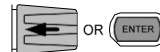



Note

The last value (A Value or B Value) you set becomes the active setting. To swap between A Value and B Value, use the A/B keys on the local load module.

When setting the current limit, ensure that the current limit is within the test device's limits.

You can set A/B Value for both High and Low range.

*Press Shift to toggle between coarse and fine adjustment when editing the A Value and B Value parameters. Refer to page 213 for details.

Select CV Range

Background Constant Voltage mode can run in high and low range. Range depends on the load module.

Ensure that the menu is in CV Mode. Refer to page 154.



- Panel Operation** 1. Press the F2 (Range) key repeatedly until High or Low range is selected.

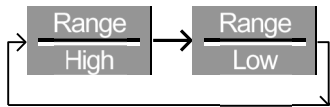

The range is reflected in both the bottom menu system and the Current Operation Channel Status panel.

CV High Range CVH

CV Low Range CVL



Note

Changing the range affects only the current (active) channel. Changes do not affect other channels.

Select CV Response Speed

Background Constant voltage mode has fast and slow response speeds. Quick current changes can induce line voltage, making it more difficult for the RMX-400x series load to maintain a constant current. In these types of conditions, slow response speed is recommended.

Maximum current range depends on the load module type.

Ensure that the menu is in CV mode. Refer to page 154.



- Panel Operation**
1. Press F3 (response) to switch between fast and slow response speeds.

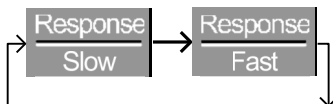

Response speed settings are reflected in the Current Operation Channel Status panel.

CV slow response	Slow
CV fast response	Fast



Changing the response speed affects only the current (active) channel. Changes do not affect other channels.

Select CP Mode

Background The RMX-400x Series electronic load operates in four different modes, constant current (CC), constant resistance (CR), constant voltage (CV), and constant power (CP).

You cannot use CP mode with the dedicated Group Unit mode.

When a channel is active, you can use the F1 key to switch between each operating mode.

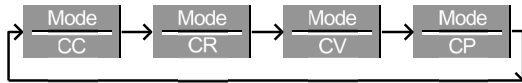

Panel Operation 1. Press the CHAN button and use the selector knob to select a channel.

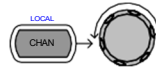

2. Press F1 until CP mode is displayed in the display panel.



Note

Changing the operating mode affects only the current (active) channel. Changes do not affect other channels.

Editing CP Parameters

Background You can set constant power mode to have a maximum limit (Curr Limit). Using the current limit enables limiting the current draw.

When using CP mode on a single-channel load module, you can configure two power levels, A Value and B Value. On a dual-channel load module, you can configure only one power level per channel: A Value.

Ensure that the menu is in CP mode. Refer to page 154.

Mode	Range			Configure
CP	Low			

Parameters	A Value	0 - Setting Max W
	B Value	0 - Setting Max W
	Curr Limit	Load module dependent

Panel Operation 1. Use the selector knob to highlight A Value.

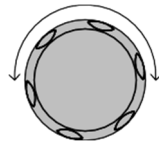



2. Press the selector knob to edit the selected value, then turn to increase or decrease the value*.

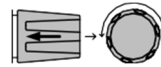

or

Use the number pad to enter a number.

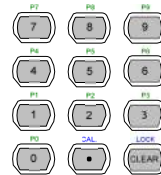

A Value 10.00 **W**

3. Press the selector knob or Enter to confirm the selection.
4. Repeat steps 1-3 for the remaining parameters.

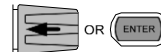

**Note**

The last Value (A Value or B Value) you set becomes the active setting. To swap between A Value and B Value, use the A/B keys on the local load module.

You can set A/B Value for both High and Low range.

When setting the current limit, ensure that the current limit is within the test device's limits.

*Press Shift to toggle between coarse and fine adjustment when editing the A Value and B Value parameters. Refer to page 213 for details.

Select CP Range

Background

Constant Power mode can run in High and Low range. The maximum range depends on the load module. Some models are only High range.

Ensure that the menu is in CP Mode. Refer to page 154.



Panel Operation

- Press the F2 (Range) key repeatedly until high or low range is selected.

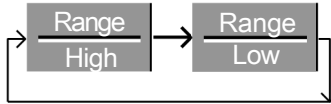

The range is reflected in both the bottom menu system and the Current Operation Channel Status panel.



CP High Range	CPH
CV Low Range	CPL



Note

Changing the range affects only the current (active) channel. Changes do not affect other channels.

Not all load modules support dual ranges. If a module supports only one range, it is usually high range.

Creating a Program Sequence

Background The RMX-400x Series has 12 programs and 10 sequences to each program, for 120 configurations.

Each sequence in each program uses the settings saved from memory data (Memory MXXX). memory data contains settings such as the mode and range for each channel. Different sequences can use the same memory data repeatedly. Each sequence loads all channels at the same time, unless programmed otherwise.

Sequence1	
CH1 M001	Run
CH2 M001	On-Time
CH3 M001	Off-Time
CH4 M001	Short-Time
CH5 M001	P/F-Time
CH6 M001	Short CH1
CH7 M001	~
CH8 M001	Short CH8

Sequences run sequentially to create a program. There are 10 sequences in each program.

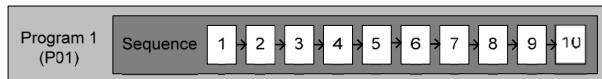

If you want fewer than 10 sequences for a program, you can skip (not run) any additional Sequences.

In the following program, sequences 2 and 3 are skipped.

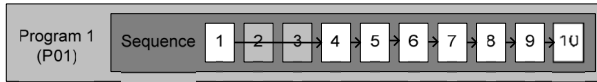

Parameters	Memory	M001-M120
	Run	Skip-auto-manual
	On-Time	0.1-60.0 seconds
	Off-Time	Off - 0.1-60.0 seconds
	P/F Time	Off - 0.1 (On-Time+Off-Time)-0.1
	Short-Time	Off - 0.1-On-Time
Short Ch		Off - 1-8 (CH1-CH8)



Note

Before you create a program, you first must preconfigure the settings for each sequence for every channel in the program and save them into channel memory (MXXX). Refer to the Save/Recall chapter for further details.

Sequence Settings

1. Press the FUNC key and then F1 (Program) to access the Program menu.





- Use the selector knob to highlight PROG:.

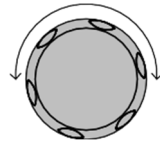

- Press the selector knob to edit PROG:, then turn to select the program number.

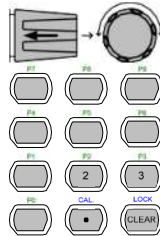

or

Use the number pad to enter a program number.

Program: 01-12

- Press Enter or the selector knob to confirm.



Repeat steps 2-4 to choose the sequence number (SEQ:).

Sequence: 01-10

- As sequences are executed sequentially, start at SEQ: 01.

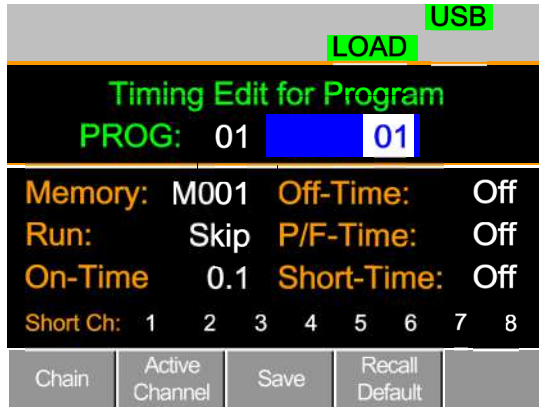

6. Repeat steps 2-4 to configure the following for the current program sequence:

Memory: M001-M120

Choose the memory data for the sequence. M001-M0120

Run: Skip – Auto - Manual

Choose whether to run the sequence in the program automatically, skip the sequence, or manually start the sequence.

On-Time: 0.1-60.0 seconds

Determines how long the sequence runs (seconds).

Off-Time: Off – 0.1-60.0 seconds

Sets how long the sequence will stay off (in seconds) between each sequence. Assuming short time is not set to OFF, Off-Time always runs after On-Time.

Short Time: Off – 0.1-On-Time (seconds)

Determines how long a short circuit lasts (seconds). However, the shorting time cannot be longer than the On-Time. Short Time starts at the same time as On-time.

P/F Time: Off – 0.1 - (On-Time+Off-Time)-0.1
(seconds)

You can set the Pass(P)/Fail(F) Delay Time to 0.1 seconds less than the total test time. The total test time is defined as:

On-Time + Off-Time (seconds)

If Go/NoGo is turned on, but the pass fail time is off, Go/NoGo test continues, but there will not be a specified pass/fail time window.

Short Channel: Off – 1-8 (CH1-CH8)

You can set each channel individually to simulate a short circuit (CH1-8) or can have shorting disabled (Off). When you set Short Channel to Off, the channel ignores the execution of Short-Time.

7. Repeat the above steps for all 10 sequences for the same (current) program.

Save Sequence

8. Press F3 (Save) to save all sequence data for all the program.



Note

The program data is not yet saved into setup memory. To save the program to setup memory, refer to page 274.

Recall Default 9. To recall the default program settings, press F4.



Note

If you recall the default, all data is lost. This does not include the internal setup memory. To see the default settings, refer to page 331.

Timing Diagram for Single Step Below is a timing diagram of a single step in a program.

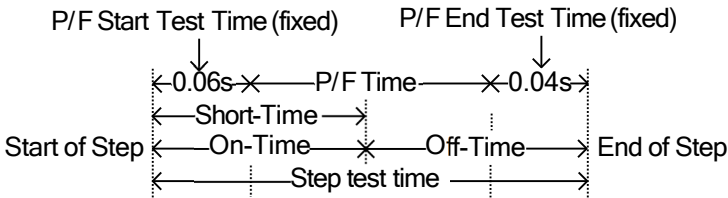

Program Chains

Background On the RMX-400x, there are up to 12 different programs containing 10 sequences.

If 10 sequences in a program sequence are not enough for testing, the RMX-400x Series can chain programs, effectively making a larger program sequence.

Unlike program sequences, program chains do not need to be run in numerical order. You can chain up to 12 program sequences.

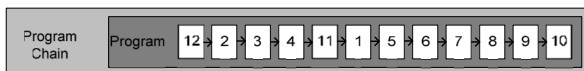

- Panel Operation**
1. Create one or more program sequences. Page 160
 2. If you created program sequences in a different session, ensure that you have loaded the programs from setup memory. Page 274
 3. Press the FUNC key, then program (F1), followed by chain (F1).

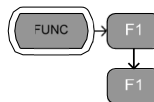

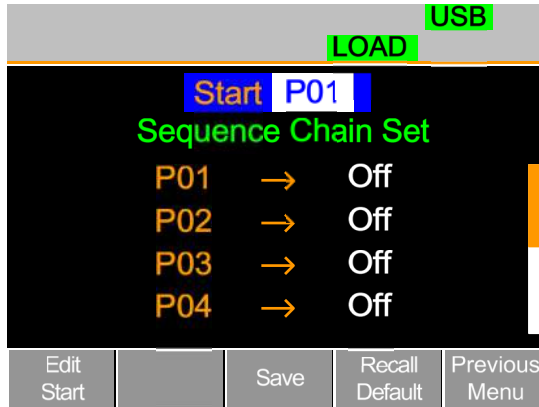

4. Press F1 (Edit Start) and use the selector knob to edit Start and confirm which program sequence (PXX) starts the program chain. You can use any program (P01-P12) to start a program chain.

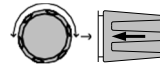

5. Use the selector knob to scroll down to P01 (program 1).

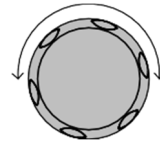

6. Use the selector knob to choose the program that will execute after P01 (P02-P12).

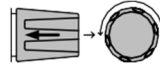

or

Select (Off) to end the program chain after (P01).

or

Select (P01) to execute after P01.
This creates a continuously looping program chain.

P01 → Off – P01-P12

- Repeat the above procedure for P02-P12 to complete the program chain.

The program chain ends at the first program (PXX) followed by Off. You can create continuously looping program chains.

Save Program Chain

- Press F3 (Save) to save the program chain.



Note

The program chain data is not yet saved into setup memory. To save the program chain to setup memory, refer to page 274.

Recall Default

- To recall the default program chain, press F4.



Note

If the default is recalled, Start reverts to P01 and all program sequences are set to Off.

Previous Menu

- Press F5 (Previous Menu) to return the sequence menu.

Running a Program

Background

Once you create a program chain/program sequence, you can execute it. As program sequences apply to all the channels, you can program any channels that do not need to be active (load off) in the Active Channel menu. At default, all channels are set to (load) Off.

EXT is shown next to any channels set to external channel control.

- Panel Operation
1. Create one or more program sequences. Page 160.
 2. Create a program chain. Page 171.
 3. Press the FUNC key, Program (F1), and Active Channel (F2).

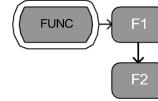

Channel 1 (CH01) is highlighted. Note that CH1 has CH CONT set to External.

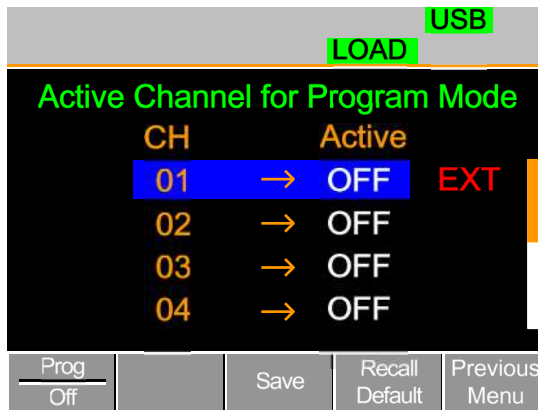

4. Edit the channel using the selector knob.

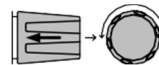

CH 01-08: ON (activate channel) – OFF (not activated)

5. Press Enter or the selector knob to confirm the selection.

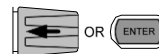

6. If needed, repeat steps 4-5 for the remaining channels.



Note

If all channels are Active OFF, you cannot run a program because there are no active channels.

Save Program

7. To save, press F3.





Recall Default 8. To recall default settings, press F4. 



Note

If you recall the default, all channels revert to Active OFF.

Previous Menu 9. Press F5 (Previous Menu) to return to the Sequence menu. 

Turn Program On/Off 10. Press F1 (Prog) to turn the current program on or off. 

Pressing F1 will cycle from program on to off.

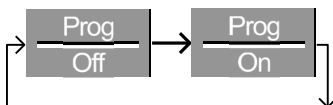

11. PROG appear on the mainframe status panel when the program is turned on.



Run Program 12. Press the load key on the mainframe to start the program. 

13. The Run Program screen appears, and the PROG icon turns orange.



As each sequence or program is completed, the screen updates to display the active sequence/program. Notice that if you have set up a channel with Go/NoGo limits, a pass (GO) or fail (NG) is displayed on the main display and the local load module display.

The program icon becomes orange when a program has started.



Note

If the Active is OFF for all the channels, *No Active Channel* is displayed instead of channel numbers.

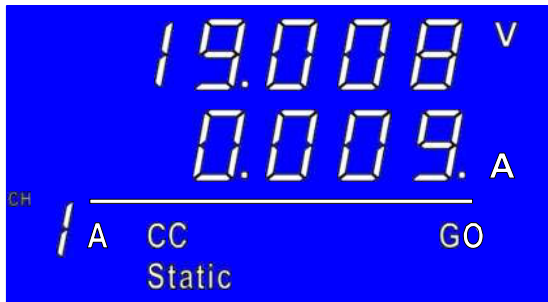

Each active load module displays the output as the program runs.

14. If you configured Run to manual in any program sequence, press F2 (Next) to continue the program sequence; otherwise, the program continues automatically.

15. Press F1 (Stop) at any time to abort the program when it is running.

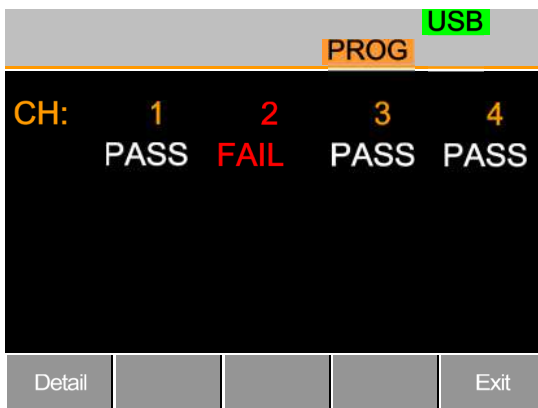

When the program finishes, the physical channels that have run are displayed, and a PASS or FAIL is displayed if you have set Go/NoGo testing.

16. When the program finishes, press F1 to see any result details.

		Channel	
P	S	1	2
1	1	G	N
1	2	G	N
1	3	G	N
1	4	G	G

Exit

The program (P) and sequence (S) numbers for the program are displayed on the left side, and the Go/NoGo (G/N) results are displayed on the right side for each channel in the program.

Use the selector knob to scroll down to view the rest of the list if necessary.

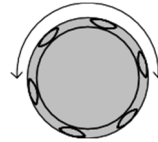

17. Press F5 to exit at any time.



Upon exiting, the previous menu before running the program loads.

Edit Sequence

Background You can configure the sequence function to create a unique load profile to accurately simulate loads in real time for single or multiple loads. You can use sequence with only CC static or CR static modes. For details, refer to page 85.

Each sequence is composed of several points with customizable current/resistance, slew rate, and duration times. You can loop each sequence an infinite amount of times. Sequences are applicable for only CC (Static) and CR (Static) modes.



Note

Do not confuse the sequence function with program sequences. You cannot use program sequences with the sequence function and vice versa.

Parameters	Value	Setting Min-Setting Max Ω/A
	SlewRate	Load module dependent
	SlewRate	
	Duration Time	0.000025-60,000 seconds

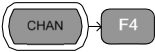
- Panel Operation**
1. Choose a channel and mode. Pages 136 and 139
 2. Press the CHAN key, F4 (Seq. Edit) to enter the Sequence Edit menu. 

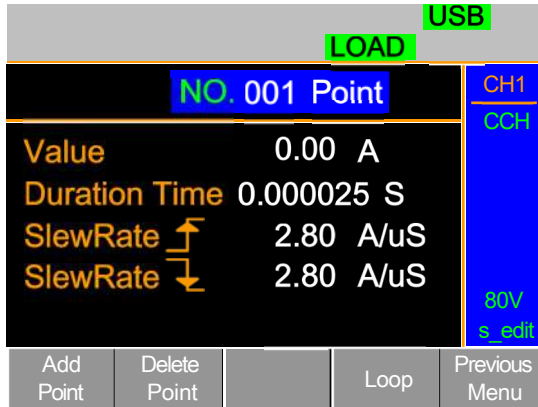

3. Use the selector knob to highlight Value.

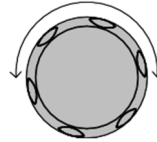

4. Press the selector knob to edit the value, then turn to increase or decrease the value.

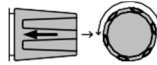

or

5. Use the number pad to enter a number.



Value 0.800 A

6. Press the selector knob or Enter to confirm the selection.

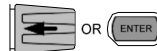

7. Repeat for rising and falling slew rate and duration time.

Add Point 8. To add an extra point after the current point, press Add Point (F1). 

Range 001-120



Note

Add Point inserts a new point directly after the current point. The current/resistance value of the inserted point is the average of the point before and after. All other settings remain unchanged.

Delete Point 9. To delete the current point, press Delete Point (F2). 

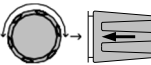
Edit Previous Point 10. Use the selector knob to change the current point number. 

 001 Point



Note

You can change the point number only if you already have added more points.

Save Sequence 11. Press Save (F3) to save the sequence. 



Note

The save icon appears only after you have made a change in the menu.

Create Sequence Loop

Background You can loop sequences can be looped many times. You can start the loops at any point in the sequence. The start of loop function determines which point starts each repeating loop.

The On End of Seq. function holds the load current (of the selected sequence) to a designated value until all other sequences finish running.

CC Vrange sets the range in CC mode for sequences.

Refer to page 85 for more details.

Ensure that the menu is in the Seq. Edit menu and that you have created a sequence. Refer to page 179.

Add Point	Delete Point		Loop	Previous Menu
-----------	--------------	--	------	---------------

Parameters	Repeat	1-9999/Infinity (0)
	Start of Loop	001-last point
	On End of Seq.	OFF/Setting Min-Setting Max
	CC Vrange (CC mode only)	High/low

Panel Operation 1. Press Loop (F4) to enter the Loop menu.



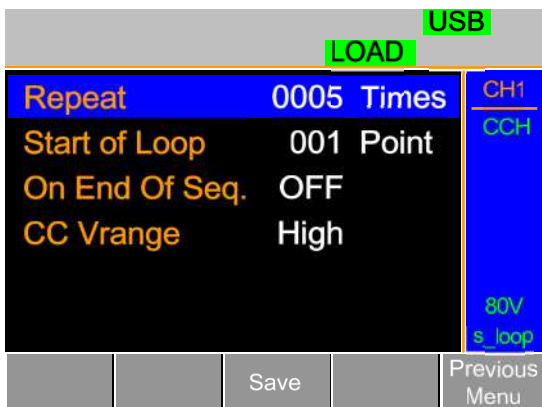

2. Use the selector knob to highlight Repeat.

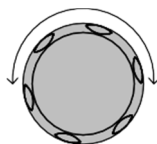

3. Press the selector knob to edit Repeat, then turn to increase or decrease the value.

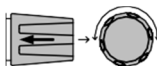

or

4. Use the number pad to enter a number.

Select 0 to choose infinity.

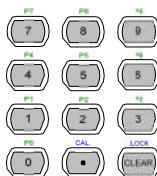

Repeat 0005 **Times**

5. Press the selector knob or Enter to confirm the selection.

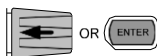

6. Repeat for the remaining parameters.

Save Loop

7. Press Save (F3) to save the loop.



Channel Duration Time Settings

Background Each sequence can have the timing duration data of another sequence. For example, CH1's sequence can import the timing duration settings of CH2's sequence.

This is useful to quickly compare two different loads to the same timing characteristics. Refer to page 85 for more details.

You can turn off each channel's sequence by configuring the channel setting to OFF. If a channel uses the same channel number, (for example, CH 01 → 01), the duration time settings are not altered for that channel.

At least one channel must output a Trigger Sequence Signal via PIN4 of the first frame link connector (master) if a sequence is run. For more details, refer to page 85.

The Trigger In signal starts any sequence with TRIG set to IN. The trigger input signal is input via PIN4 of the second frame link connector (slave).

For more details, refer to page 85.

Any channels with channel control (CH CONT) set to external are shown on the right side as EXT. Refer to page 208 for details of setting channel control.

Parameter	CH 01-08 Setting	OFF-maximum channels
	CH 01-08 TRIG	IN, OUT, IN/OUT, OFF

Ensure that you have created and saved at least one sequence. Refer to page 179.

Panel Operation

1. Press FUNC, then Sequence (F2) to enter the Channel Duration Time menu.

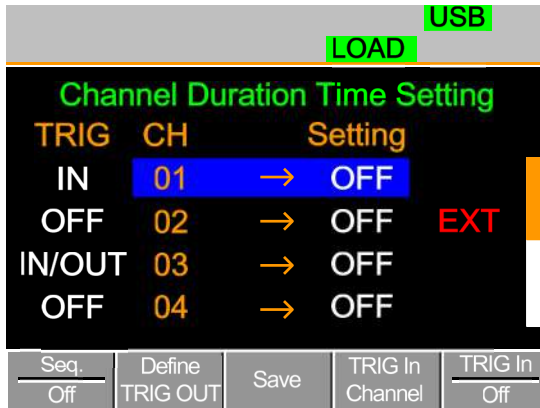
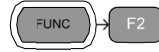

Note that CH3 is set to TRIG OUT, while CH1 and CH3 are set to TRIG IN. CH2 has no trigger settings and has CH CONT set to external.

2. Use the selector knob to highlight a channel.

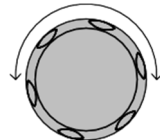

3. Press the selector knob to edit the channel, and then turn to choose which channel's duration time setting to import.

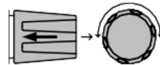





Range

Ch 01-08 / OFF

01 → 01

4. Press the selector knob or Enter to confirm the selection.



- | | | |
|---------------------|---|---|
| Trigger Out Channel | 5. Press Define TRIG OUT (F2) if you want the currently selected channel to output the Trigger sequence signal. |  |
| | You must set one channel as the TRIG OUT channel. | |
| Trigger In Channel | 6. Press TRIG In Channel (F4) to allow the current sequence to be triggered with the Input trigger. |  |
| Trigger In On/Off | 7. To turn the Input trigger source on, press Trig In (F5). |  |
| | 8. Repeat the previous steps for any other remaining channels. | |
| Save Settings | 9. Press Save (F3) to save the settings. |  |

Run Sequence

Background Like programs, you must turn on sequences before you can run them.

When running a Sequence, the front panel function keys, number pad, operation keys, and selector knob are disabled for the specific channel(s). The load module panel is also disabled (except the display key) for the specific channel.

You still can edit channels that do not have a sequence by changing channels via the CHAN key or by using the local load module.

Ensure that you have created and saved Page 179 at least one sequence.

Ensure that you also have configured the channel duration time settings and that no sequence (CH01-08) that you want to run is set to off. Page 184

Panel Operation

1. Press FUNC, then Sequence (F2) to enter the Channel Duration Time Setting menu.

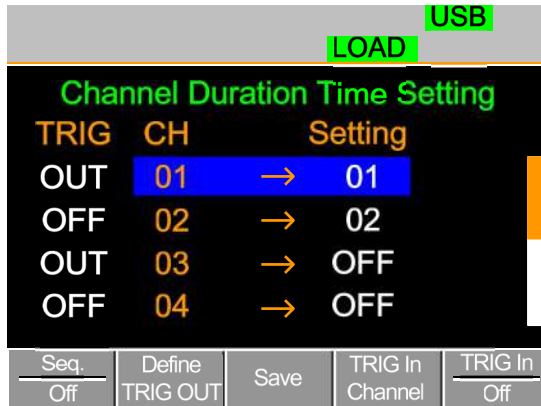

2. Press Seq. (F1) to turn on the sequences.
3. SEQ is displayed on the Mainframe Status panel.



4. Press the LOAD key to run all sequences. If a channel has TRIG set to IN, that channel now waits for a trigger before running.
5. Run SEQ Mode is displayed on the bottom of the display for the specific channels. On the Mainframe Status panel, SEQ turns orange.

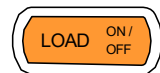

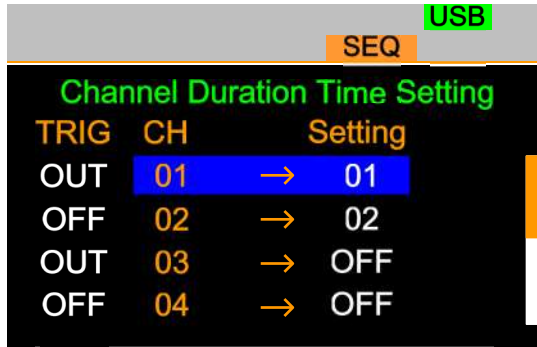

Run SEQ Mode

Stop the load

6. Press the LOAD key again or wait for the sequence (if not infinitely looped) to end/stop the load.

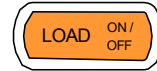

Turn off SEQ

7. Press Seq. (F1) to turn off the sequence(s) when the load is not running.

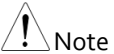

Note

All UI keys/knobs are disabled for all channels that run a sequence, except the function keys and R/L keys.

OCP Test Automation

Background The OCP test function creates an automatic test to test the OCP of power supply products.

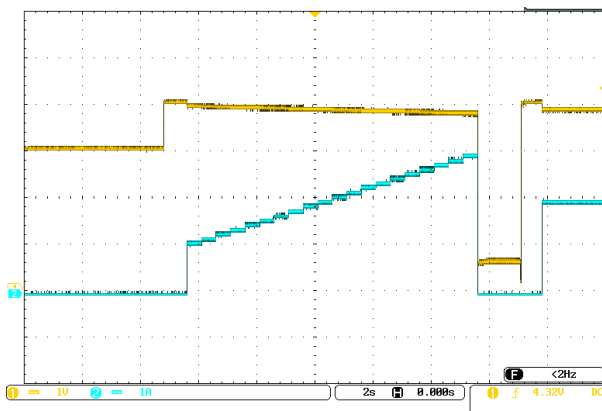

Parameters	Active Channel	Applies the setting to the load channel.
	Range	High (CC mode high) or low (CC mode low)
	Start Current (Start C)	Starting current value for the test.
	End Current (End C)	The current value that ends the test. The value must be higher than the OCP value of the DUT you are testing. This parameter is a fail-safe if the DUT over current protection fails.
	Step Current (Step_C)	Sets the step resolution of the current.

- Last Current (Last_C) Sets the final current value after OCP has tripped. This is the steady-state current draw after the OCP has tripped.
- Step Time (Step_T) Sets each step's execution time. (50 ms-1600 s)
- Delay Time (Delay) The OCP testing delay time. Sets the how long to delay starting the test after you press the Load On key. (0-160 s)
- Trig Voltage (Trig_V) Sets the voltage trigger level needed to see whether the power supply OCP has been triggered.

When the power supply OCP has triggered, its voltage output drops. Use the voltage trigger level to test to see whether the voltage output has been dropped.

- Keep Time (Keep_T) Set how long to enter the Last Current after detecting the OCP. (0-160 s)



Note

Use this mode only under CC mode.

- Panel Operation
1. Press the FUNC key F4 (OCP) to enter the OCP Test Automation menu.





- Use the selector knob to highlight the parameter you want to edit.

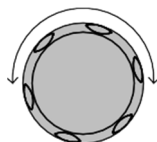

- Press the selector knob to edit the parameter, then turn to increase or decrease the value.

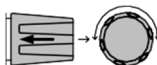

or

Use the number pad to enter a number.

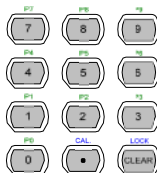

- Press the selector knob or Enter to confirm the selection.
- Repeat steps 2-4 for all parameters.



Save the OCP Test Automation Settings

Press Save (F3) to save the OCP Test Automation settings.





Select Active Channel

7. To select the load channels for the test, press Active Channel (F2).

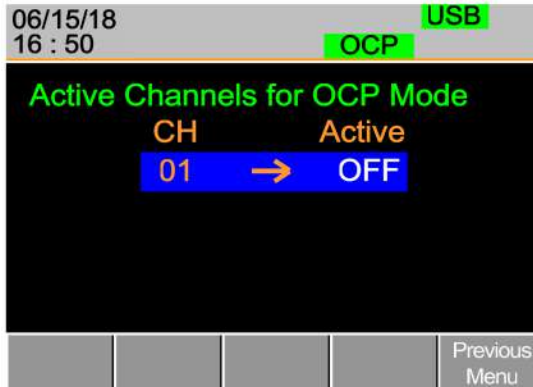

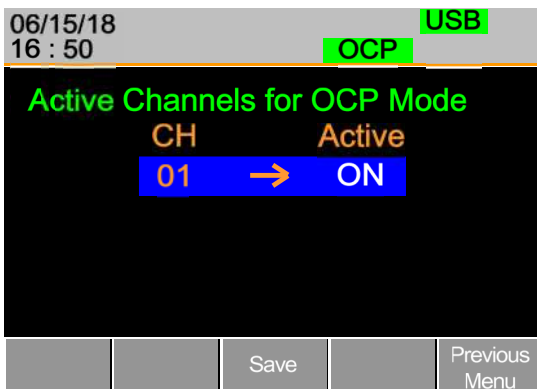

8. Use the selector knob to Enter key to turn the Active value to on.



- Save the OCP Test 9. Press Save (F3) to save the OCP Automation Channel



10. Press Previous Menu (F5) to return to the OCP Test Automation menu.



11. Press OCP (F1) to turn OCP to on.



Save the OCP Test Automation Parameters 12. Press Save (F3) to save the OCP test automation parameters.



Start the OCP Test Automation 13. Press the Load key to start OCP Test Automation.

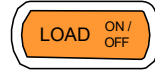

Test Results 14. Review the test results.

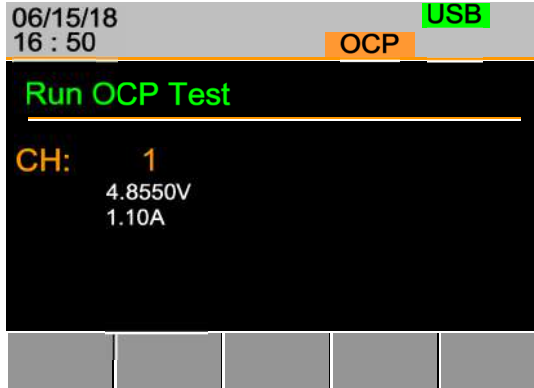

Voltage reading: The DUT voltage before the OCP was triggered.

Current reading: The DUT current before the OCP was triggered.



In addition to the setting the OCP test parameters as described above, you also must set the Von voltage settings according to the DUT output characteristics.

The following image shows an OCP Test Automation example using actual current and voltage waveforms.

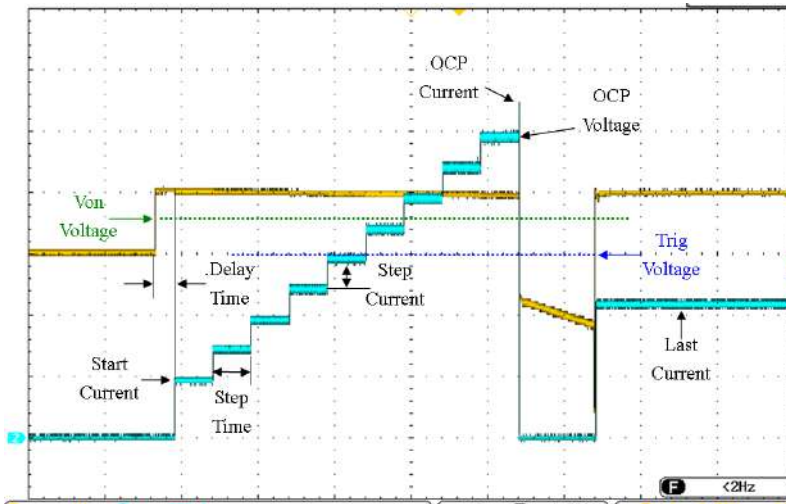

Channel Configuration

This chapter describes the configuration options for individual channels. Any configuration settings you change apply to only the current channel; other channels are not changed.

Accessing the Configuration Menu

Background Use the configuration menu to access instrument settings and properties and set the protection levels for each channel.

Panel Operation 1. Select the channel to be configured by pressing the CHAN key and using the selector knob.

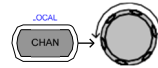

2. Press the F5 (Configure) key to enter the configuration (Protection) menu.

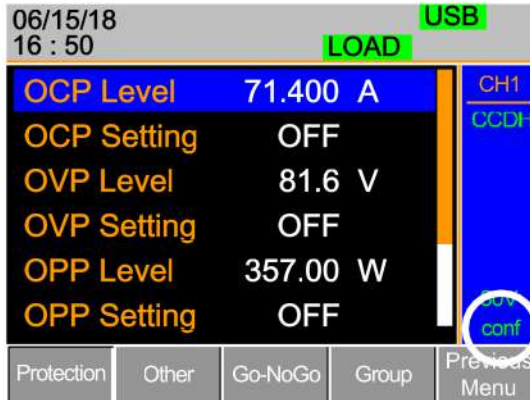

Setting OCP/OVP/OPP/UVP

Background Use over protection to set the voltage, current, or power limit. In the event that the current, voltage, or power exceeds the over protection settings, the load module display shows an error message and beeps an alarm.

When tripped, under voltage protection (UVP) will turn off the load. UVP trips when the load voltage drops below a set limit.

The protection modes are active only when the protection settings are set to on (XXP Setting -On).

You can set all protection settings to 2% higher than specification rating.

Parameters	OCP Level	1.25% Rating A-102% Rating A
	OCP Setting	ON/OFF/Clear
	OVP Level	1.25% Rating V-102% Rating V (0.5% Rating V-102% Rating V for RMX-4006)
	OVP Setting	ON/OFF/Clear
	OPP Level	RMX-4003 : 1 W-102 W RMX-4004 (L) : 0.9 W-30.6 W RMX-4004 (R) : 1.25 W-255 W RMX-4005 : 1.75 W-357 W RMX-4006 : 1.75 W-357 W
	OPP Setting	ON/OFF/Clear
	UVP Level	OFF—current using operating voltage range of slave module.
	UVP Setting	Clear

Protection Clear All

Panel Operation Ensure that you are in the configuration menu. Refer to page 196.

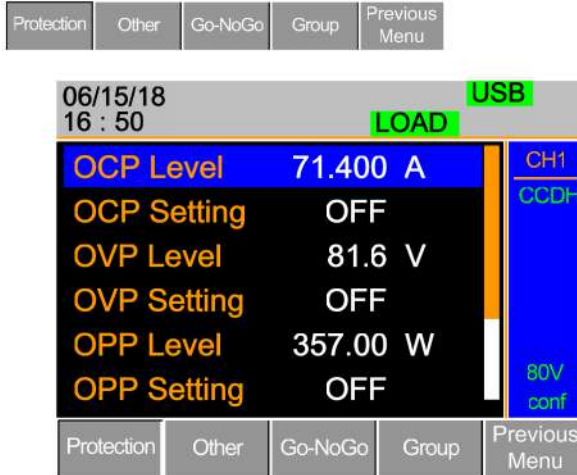

1. Use the selector knob to highlight OCP Level.

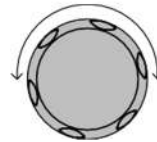

2. Press the selector knob to edit the selected level, then turn to increase or decrease the value.

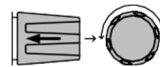

or

3. Use the number pad to enter a number.

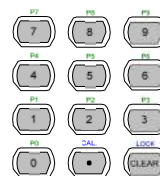

OCP Level 71.400 A

4. Press the selector knob or Enter to confirm the selection.

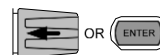

5. Use the selector knob to highlight OCP Setting.

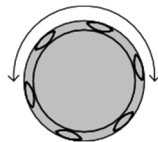

6. Use the selector knob to turn ON, turn OFF, or CLEAR the OCP Setting.

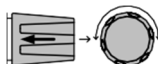

7. Repeat steps 1-5 for:
- OCP Level
 - OVP Level
 - OVP Setting
 - OPP Level
 - OPP Setting
 - UVP Level
 - UVP Setting

Clearing an Alarm When any protection setting is tripped, Alarm displays on the Mainframe Status Panel, and an alarm tone sounds by default.

On the local load module, the tripped protection setting is displayed.

OCP	<i>0</i>	<i>C</i>	<i>P</i>
OVP	<i>0</i>	<i>U</i>	<i>P</i>
REV*	<i>r</i>	<i>E</i>	<i>U</i>
OPP	<i>0</i>	<i>P</i>	<i>P</i>
OTP*	<i>0</i>	<i>t</i>	<i>P</i>
CPP*	<i>C</i>	<i>P</i>	<i>P</i>
UVP	<i>U</i>	<i>U</i>	<i>P</i>

8. Turn the load off by pressing the Load key, and turn off the load input.
9. Change the XXP Setting to Clear to clear the alarm.



OCP Setting

Clear



Note

*You cannot clear REV, OTP, and CPP using this method. You must use the Protection Clear function instead. Refer to page 200.

Refer to pages 67 and 318 to output alarms via the Go/NoGo output terminal.

The configuration settings apply to only the current channel.

Protection Clear

Background

When any protection circuit tripped, use the Protection Clear function to reset the alarms.

Alarm will display on the Mainframe Status Panel, and an alarm tone sounds by default when any protection setting is tripped.



On the local load module, the tripped protection setting is displayed.

Example: Reverse Voltage Protection



OCP	0	[P
OVP	0	U	P
REV	r	E	U
OPP	0	P	P
OTP	0	t	P
CPP	[P	P
UVP	U	U	P

Panel Operation Ensure that the menu is in the configuration menu. Refer to page 196.



1. Turn the load off by pressing the load key if necessary.
2. Use the selector knob to scroll down to Protection Clear.

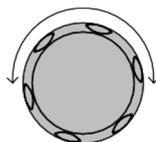

Protection Clear All

3. Press the selector knob or Enter to clear all.



Note

The configuration settings apply to only the current channel. Other channels are not affected.

Setting the CC Voltage Range

Background You can set the Constant Current Voltage range to high or low.

Parameter CC Vrange High/Low

Panel Operation Ensure that the menu is in the configuration menu. Refer to page 196.



1. Press the F2 (Other) key to enter the Other menu.

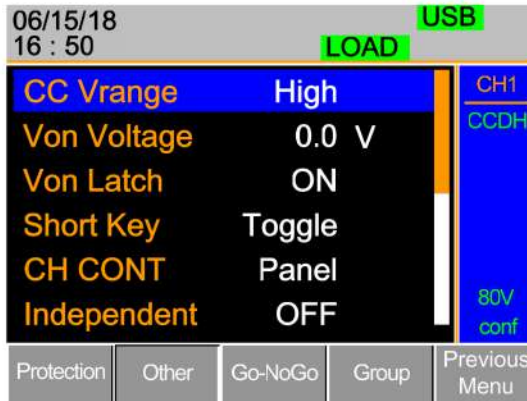

2. Use the selector knob to highlight CC Vrange.

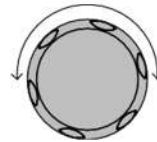

3. Press the selector knob to edit CC Vrange, then turn to increase or decrease the range.

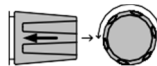

CC Vrange **High**

4. Press the selector knob or Enter to confirm the selection.

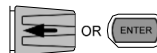

Note

The configuration settings apply to only the current channel.

Adjusting the Von Voltage and Latch

Background The Von voltage is the voltage point at which the load module will start to sink current. When Von latch is set to ON, the load continues to sink current after being tripped, even if the voltage drops below the Von voltage level. The step resolution of Von voltage is load module dependent.

Parameters Von voltage 0.0-Rating volts
 Von latch ON/OFF

Panel Operation Ensure that the menu is in the configuration menu. Refer to page 196.



1. Press the F2 (Other) key to enter the Other menu.

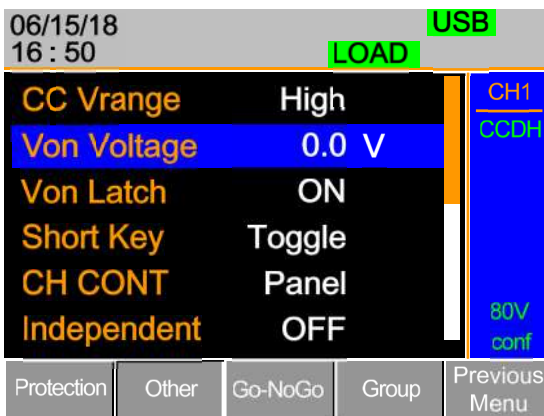

- Use the selector knob to highlight Von voltage.

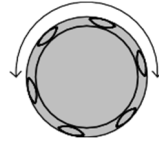

- Press the selector knob to edit the selected value, then turn to increase or decrease the value.

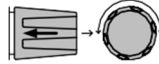

or

Use the number pad to enter a number.



Von Voltage

0.0 V

- Press the selector knob or Enter to confirm the selection.
- Repeat steps 3 to 5 to turn Von latch ON or OFF



For details of Von and Latch settings, refer to page 94.



Note

The configuration settings apply to only the current channel. Other channels are not affected.

Configuring the Short Settings

Background	<p>Use the Short Key option to simulate a short circuit.</p> <p>Use the Short Function option to set whether the short function is enabled or disabled.</p> <p>You can configure the Short Key option to toggle (press SHORT on the load module to toggle ON or OFF) or Hold (hold the SHORT key to short the load).</p> <p>Use the Short Safety option to set whether enabling the short function depends on Load ON. When set to ON, the short function is enabled only when Load ON mode is enabled. When set to OFF, the short function is directly enabled independent of the Load ON mode.</p>
------------	--

Parameter	Short Function	ON/OFF
	Short Key	Hold/Toggle
	Short Safety	ON/OFF

Panel Operation	Ensure that the menu is in the configuration menu. Refer to page 196.
-----------------	---



1. Press the F2 (Other) key to enter the Other menu.



06/15/18		USB	
16:50		LOAD	
CVL Step	0.0004 V		CH1
CPH Step	0.01 W		CVH
CPL Step	0.001 W		
Short Function	ON		Slow
Short Key	Toggle		80V
Short Safety	ON		conf
Protection	Other	Go-NoGo	Group
			Previous Menu

2. Use the selector knob to highlight Short Function.

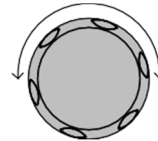

3. Press the selector knob to edit the selected setting, and turn to change the setting.

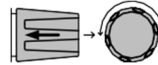

Short Function

ON

4. Press the selector knob or Enter to confirm the selection.

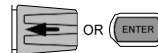

5. Use the selector knob to highlight Short Key.

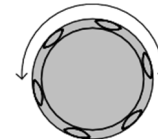

6. Press the selector knob to edit the selected setting, and turn to change the setting.

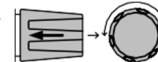

Short Key

Toggle

7. Press the selector knob or Enter to confirm the selection.



8. Use the selector knob to highlight Short Safety.

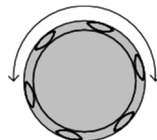

9. Press the selector knob to edit the selected setting, and turn to change the setting.

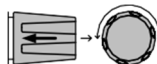

Short Safety

ON

10. Press the selector knob or Enter to confirm the selection.

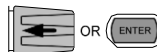

Configuring Channel Control

Background When you set channel control (CH CONT) to external, it disables editing the active channel load. You still can use instrument buttons and knobs to access the menu for the active channel or to edit other channels that do not have channel control active. This prevents settings on the active channel from being changed on the local machine. Refer to pages 63 and 100 for details.

Parameter	CH CONT	Panel/External
-----------	---------	----------------

Panel Operation Ensure that the menu is in the configuration menu. Refer to page 196.



1. Press the F2 (Other) key to enter the Other menu.

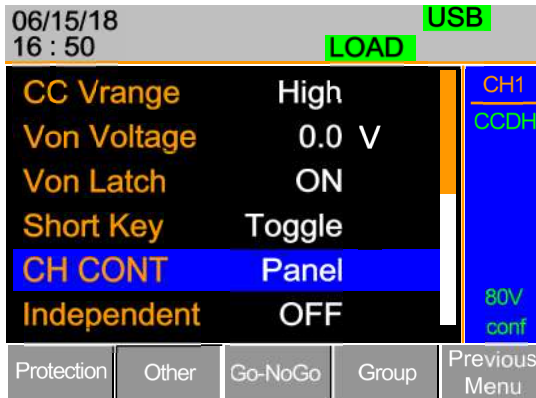

- Use the selector knob to highlight CH CONT.

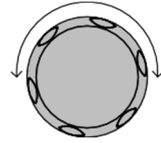

- Press the selector knob to edit the selected setting, and turn to change the setting from panel to external.

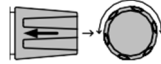

CH CONT External

- Press the selector knob or Enter to confirm the selection.



Channel control is now activated. To turn channel control off, you must set CH CONT to panel again. When channel control is active, EXT is displayed on the side panel for the active channel.



Note

You can activate channel control on only the active channel; other channels are not affected.

Configuring the Independent Setting

Background The independent setting allows a channel to be load independent from the mainframe. This means that a load module with independent set to on can load from only the local load module. If you press the LOAD ON/OFF key from the mainframe, the mainframe does not affect the channel with independent set to on, except when running a program.

Parameter Independent ON/ OFF

Panel Operation Ensure that the menu is in the configuration menu. Refer to page 196.



1. Press the F2 (Other) key to enter the Other menu.

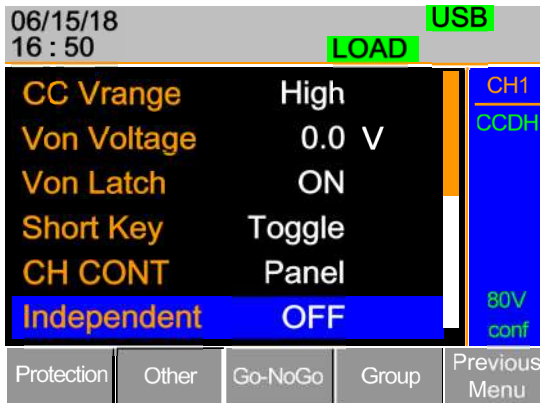

2. Use the selector knob to highlight Independent.

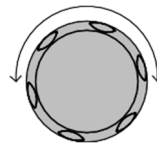

- Press the selector knob to edit the selected setting, and turn to change the setting.

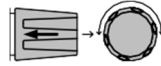

Independent

OFF

- Press the selector knob or Enter to confirm the selection.



When you set a channel to independent, an asterisk(*) appears next to the channel number indicator in the Current Operation Channel Status panel.



Note

The configuration settings apply to only the current channel. Other channels are not affected.

Configuring the Load Delay Time

Background The mainframe can delay loading a channel by up to 10 seconds. However, the delay time applies only to manual loading. Delay time does not apply to programs or sequences.

Parameter Load D-Time 0-10 s

Panel Operation Ensure that you are in the configuration menu. Refer to page 196.



- Press the F2 (Other) key to enter the Other menu.



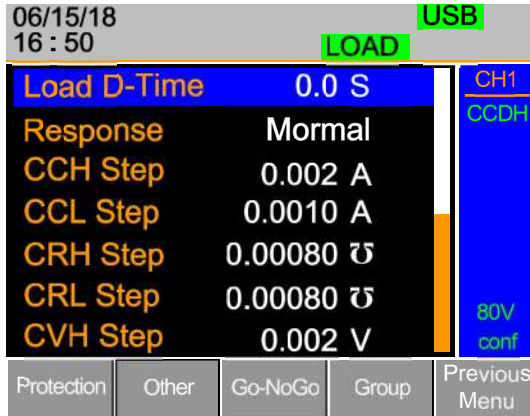

- Use the selector knob to highlight Load D-Time.

Note: Load D-Time is below Independent, off screen.

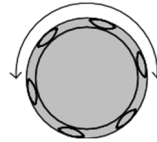

- Press the selector knob to edit the selected setting, and turn to change the setting.

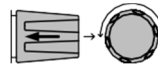

or

Use the number pad to enter a number.



Load D-Time **0.0 S**

- Press the selector knob or Enter to confirm the selection.

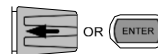

Note

The Delay Time applies to only the current channel; other channels are not affected.

Delay time applies only when you manually turn on the load or during start up with the Auto Load On setting (refer to page 226).

Configuring Step Resolution

Background You can edit the CC, CR, CV, and CP step resolution settings in the configuration menu. These step resolution settings directly correspond to the step resolution of the coarse adjustment when setting the CC, CR, CV, and CP parameters.

The minimum and maximum step resolution you can set for each channel is dependent on the load module. For more information about step resolution, refer to page 94.

Step Resolution		Minimum*1	Maximum*2	Unit
RMX-4003	CCH Step	HR/20000	HR/2	Amperes A
	CCL Step	LR/20000	LR/2	Amperes A
	CRH Step	HR/40000	HR/2	Siemens \bar{U}
	CRL Step	LR/40000	LR/2	Siemens \bar{U}
	CVH Step	HR/40000	HR/2	Voltage V
	CVL Step	LR/40000	LR/2	Voltage V
	CPH Step	HR/10000	HR/2	Watt W
	CPL Step	LR/10000	LR/2	Watt W
RMX-4004 (L)	CCH Step	HR/40000	HR/2	Amperes A
	CRH Step	HR/40000	HR/2	Siemens \bar{U}
	CRL Step	LR/40000	LR/2	Siemens \bar{U}
	CVH Step	HR/40000	HR/2	Voltage V
	CVL Step	LR/40000	LR/2	Voltage V
	CPH Step	HR/30000	HR/2	Watt W

RMX-4004 (R)	CCH Step	HR/40000	HR/2	Amperes A
	CCL Step	LR/40000	LR/2	Amperes A
	CRH Step	HR/40000	HR/2	Siemens Ū
	CRL Step	LR/40000	LR/2	Siemens Ū
	CVH Step	HR/40000	HR/2	Voltage V
	CVL Step	LR/40000	LR/2	Voltage V
	CPH Step	HR/25000	HR/2	Watt W
	CPL Step	LR/25000	LR/2	Watt W

RMX-4005	CCH Step	HR/35000	HR/2	Amperes A
	CCL Step	LR/35000	LR/2	Amperes A
	CRH Step	HR/40000	HR/2	Siemens \bar{U}
	CRL Step	LR/40000	LR/2	Siemens \bar{U}
	CVH Step	HR/40000	HR/2	Voltage V
	CVL Step	LR/40000	LR/2	Voltage V
	CPH Step	HR/35000	HR/2	Watt W
	CPL Step	LR/35000	LR/2	Watt W
RMX-4006	CCH Step	HR/20000	HR/2	Amperes A
	CCL Step	LR/20000	LR/2	Amperes A
	CRH Step	HR/40000	HR/2	Siemens \bar{U}
	CRL Step	LR/40000	LR/2	Siemens \bar{U}
	CVH Step	HR/50000	HR/2	Voltage V
	CVL Step	LR/50000	LR/2	Voltage V
	CPH Step	HR/35000	HR/2	Watt W
	CPL Step	LR/35000	LR/2	Watt W

¹ HR = High range rated value. LR = Low range rated value.

² Maximum value = HR (LR)/2 * 1.02.



Note

Use the Shift key to toggle between coarse and fine adjustment mode when editing the CC, CR, CV, and CP values with the Selector knob on the main display. The fine adjustment resolution varies between the function and load module used.

Coarse mode:

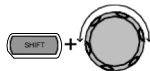

Fine mode:

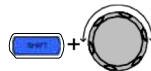

Panel Operation Ensure that you are in the configuration menu. Refer to page 196.



1. Press the F2 (Other) key to enter the Other menu.

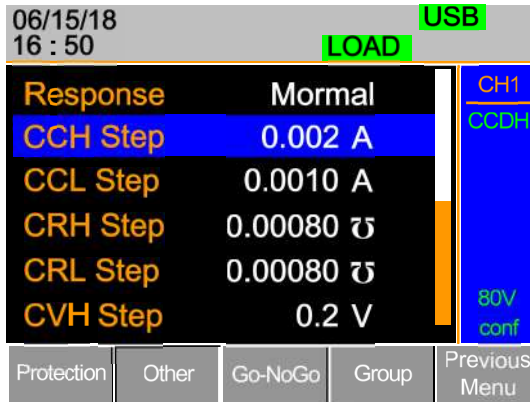

2. Use the selector knob to scroll down to highlight CCH Step.

Note: CCH Step is off screen when entering the Other menu.

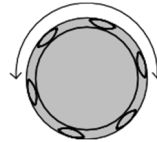

Note

CCH Step is off-screen when entering Other menu.

3. Press the selector knob to edit the selected setting, and turn to change the setting.

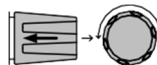

or

Use the number pad to enter a number.



CCH Step
0.002 A

4. Press the selector knob or Enter to confirm the selection.
5. Repeat steps 2-4 to edit the step resolution of:
 - CCL Step
 - CRH Step
 - CRL Step
 - CV Step

Note

The Step resolution settings apply to only the active channel; other channels are not affected.

Configuring Response Time

Background Use the Response time setting to limit current draw when input voltage is less than 1 V. The Response setting sets the load bandwidth to fast (100 MHz) or normal (1 kHz).

Parameters Response Normal, Fast

Panel Operation Ensure that you are in the configuration menu. Refer to page 196.

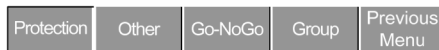

1. Press the F2 (Other) key to enter the Other menu.



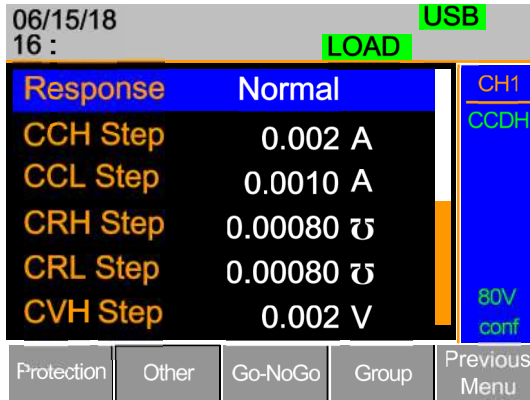

- Use the selector knob to scroll down to highlight Response.

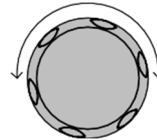

Note

Response is offscreen when entering Other menu.

- Press the selector knob to edit the selected setting, and turn to change the setting.

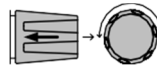

Response Normal

- Press the selector knob or Enter to confirm the selection.

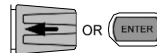

Note

The Response settings apply to only the active channel; other channels are not affected.

Go/NoGo

Background Use Go/NoGo mode to set threshold limits. When a load is within the limit(s), it is considered to be “Go”; when the load exceeds the limit, it is considered to be “NoGo.”

You can set Go/NoGo limits as either absolute values (entry mode set to “Value”) or a percentage offset from a nominal (center) value (entry mode set to “Percent”).

You can use Go/NoGo in both high and low ranges, as well as CC, CV, CR, and CP modes. You can read the Go/NoGo status using the rear Go/NoGo output.

You also can impose a delay time for up to 1 second.



Note

Any Go/NoGo configuration applies to only the current channel with the same mode and range.

Parameters	Value	Percent
CC Mode	High: V	High: %
CR Mode	Low: V	Low: % Center: V
CV Mode	High: A	High: %
CP Mode	Low: A	Low: % Center: A
Delay Time	0.0-1.0 seconds	
SPEC Test	ON/OFF	

Panel Operation Ensure that you are in the Configuration menu. Refer to page 196.

Protection	Other	Go-NoGo	Group	Previous Menu
------------	-------	---------	-------	---------------

Choose Absolute/ Percentage Limits 1. Press Go-NoGo (F3) to access the Go/NoGo menu.



2. Use the selector knob to edit Entry Mode.

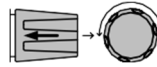

3. Choose Value for absolute limits or Percent for percentage offset limits.

Entry Mode Value

Or

Entry Mode Percent

4. The menu changes according to the selection.

Value

Percent

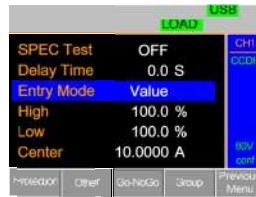

5. Use the selector knob and number pad to edit Delay time, High, Low, and Center (percent mode only).

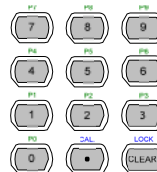
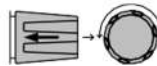

6. Press the selector knob or Enter to confirm each value.



Turn Go/NoGo
On/Off

- Use the selector knob to edit SPEC test.

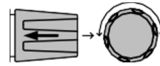

- Choose ON to turn on Go/NoGo.

SPEC Test **ON**

- Choose OFF to turn off Go/NoGo.

SPEC Test **OFF**

When SPEC test is set to ON, SPEC appears on the Current Operation Channel Status panel.



Group Unit

Background Use the Group Unit menu to configure load modules of the same type and rating as a single unit when used in parallel. You can use up to four load modules in this mode.

Operating the RMX-400x series load modules in Group Unit mode is almost the same as using the load modules separately. The only difference is that you need to set up the channel configuration for only channel 1 and not individually for each channel.

There are two mode types: para and sync. Use the para setting to operate the all parallelized load modules as a single large load module. Use sync mode to synchronize the settings of a single unit across all other parallelized load modules.

The display mode determines which parameters are displayed on the local load modules.



Note

You can use only CC or CR mode in Group Unit.

The single channel load modules, RMX-4005 and RMX-4006, fully support these two modes (Para, Sync) of group function.

The RMX-4004 does not support group function.

The dual channel RMX-4003 does partially support group function. It can support grouping two units of the same module under the Sync mode only. That means the RMX-4003 can be 2 ch x 100 W or 1 ch x 200 W.

Ensure that you use the same firmware for both units.

Parameters	Total Unit	2/3/4/OFF
	Group Mode	Para/Sync
	Display Mode	V,I/V,W/I,W/S

- Panel Operation
1. Ensure that the current channel is selected as the active channel. Refer to page 137.
 2. Ensure that the menu is in the Configuration menu. Refer to page 196.



- Parallel Setup
3. Press Group (F4) to access the Group menu.

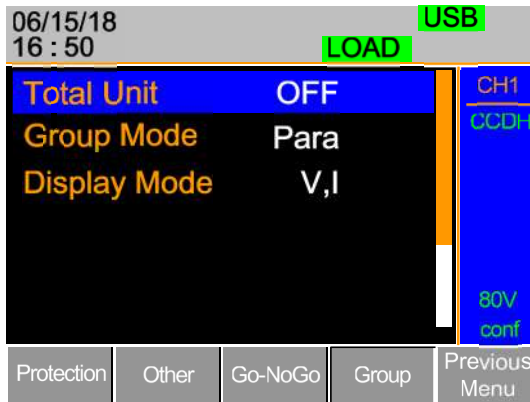

4. Use the selector knob to change Total Unit from the OFF setting to the number of parallel units.

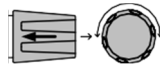

Total Unit 2

5. Press the selector knob or Enter to confirm.



- Parallel Mode
6. To change the type of mode, use the selector knob to edit Group Mode.

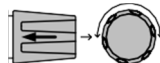

- Choose Para to operate the units as a single large load module, or Sync to synchronize the load settings across each parallel unit.

Parallel Mode **Para**

Display Mode

- Use the selector knob to change the display settings on the local load modules.
- Choose from V,I/V,W/I,W, or S.

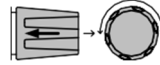

Display Mode **V,I**

When para unit is active, an indicator appears on the screen. The indicator depends on the Group mode. P appears for para mode and S appears for sync mode.

CHXP	Para mode
CHXS	Sync mode



The RMX-400x is now ready to operate in parallel mode.

Turn Parallel Mode Off

- To disable parallel mode, use the selector knob to change Total Unit to OFF.

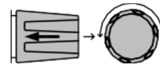

Total Unit **OFF**

Mainframe Configuration

This chapter describes configuration settings that apply to all channels and general interface settings.

Accessing System Information

Background	The system information displays the mainframe and load module(s) serial numbers.
------------	--

Parameters	<p>Mainframe Ver: Mainframe firmware version and date (month/day).</p> <p>RMX-400x SN: Mainframe serial number.</p> <p>SlotX(Y) Ver: The version number of the Xth load module occupying the Xth slot with channel number Y.</p> <p>RMX-400x SN: The serial number and module model of the Xth load module</p> <p>Y designates the channel of each installed load module. For example, if dual channel load modules are installed, Ch (1,2) is for the firmware and serial number.</p>
------------	--

Panel Operation	<ol style="list-style-type: none"> 1. Press the Shift key and then Help key to access the Utility menu/System Info menu.
-----------------	---

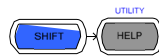

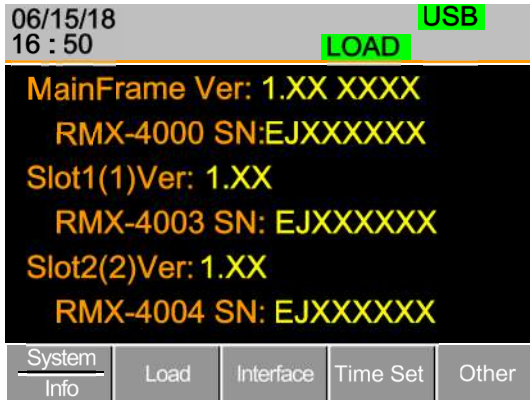

Note

If you have set Memo through commands, you can see the Memo information by pressing System Info (F1) once again. (Refer to the chapter describing the :MEMO and :CHANnel:MEMO commands in the programming manual for details.)

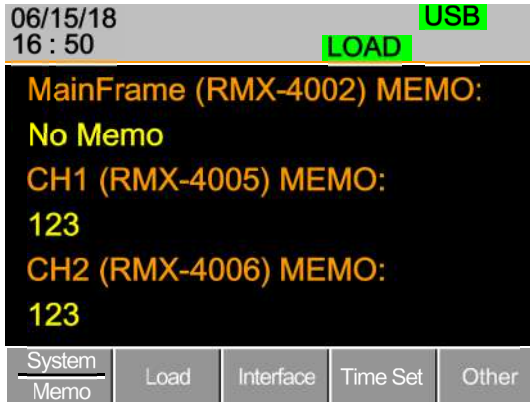



Accessing the Load Menu

Background The RMX-400x series can automatically start loading from the last program or load setting.

If you set Auto Load On to Load, the last load setup used before the machine was reset automatically starts to load on startup.

If program is set to the auto load on configuration, the last program executed starts on the next startup.

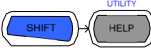
Parameters	Auto Load	ON/OFF
	Auto Load On	Load/program

- Panel Operation**
1. Press the Shift key and then the Help key to access the Utility menu.
 
 2. Press F2 (Load).
 

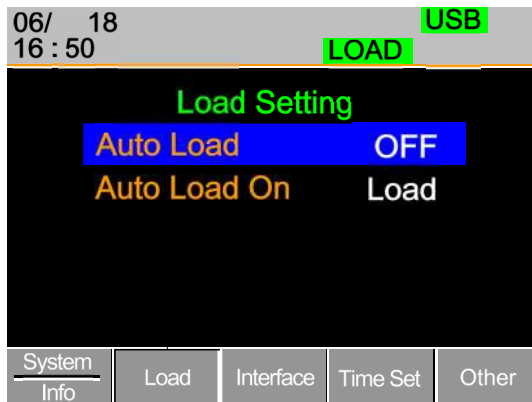

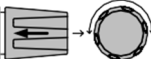
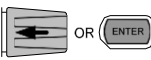
3. Press the selector knob and then turn to choose Auto Load.
 
4. Press the selector knob or Enter to confirm the selection.
 

5. Scroll to Auto Load On and choose Load or Program for the next time the RMX-400x starts.

Adjusting the Speaker

Background The RMX series has an internal speaker for both the mainframe and load modules. The speaker function turns the UI sound on or off (key presses and scrolling). The speaker setting does not alter the sound for protection or Go/NoGo alarms.

Parameter Speaker ON/OFF

- Panel Operation**
1. Press the Shift key and then the Help key to access the Utility menu.
 2. Press F5 (Other menu).

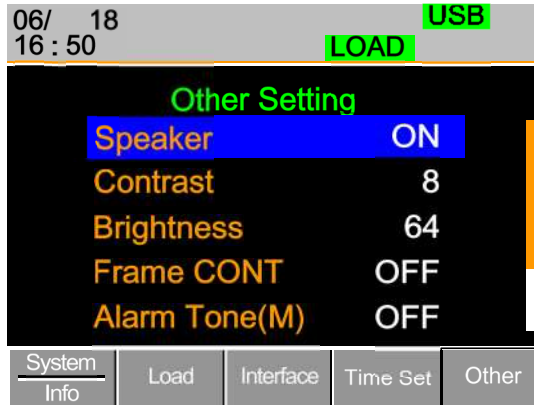
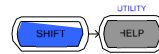

3. Use the selector knob to highlight Speaker.

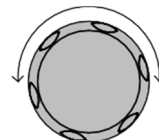

- Press the selector knob to edit Speaker, then turn to change from on to off and vice versa.

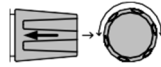

Speaker

ON

- Press the selector knob or Enter to confirm the selection.



Adjusting the Display Settings

Background The RMX series has a TFT LCD display. Use the Utility menu to control the display brightness and contrast.

Parameters	Brightness	50-90	50 (low)	90 (bright)
	Contrast	3-13	3 (low)	13 (high)

- Press the Shift key and then the Help key to access the Utility menu.

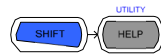

- Press F5 (Other menu).

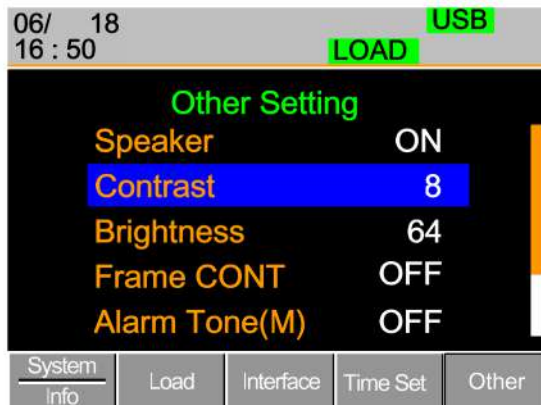

3. Use the selector knob to highlight Contrast.

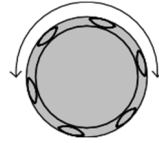

4. Press the selector knob to edit contrast, then turn to increase or decrease the value.

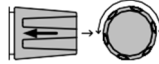

Contrast

8

5. Press the selector knob or Enter to confirm the selection.



6. Repeat steps 3-5 for the brightness.

Adjusting the Frame Control

Background Use frame control to control several frame-linked mainframes (slaves) with a master mainframe. For information about frame control, frame control interface, and connection, refer to pages 61 and 315.



Note

When using frame control, ensure that the same firmware is installed in both master and slave units.

Parameters Frame CONT ON/OFF

- Panel Operation**
1. Connect the mainframes using a frame link connection. Page 61.
 2. On the master mainframe, press the Shift key and then the Help key to access the Utility menu.
 3. Press F5 (Other menu).

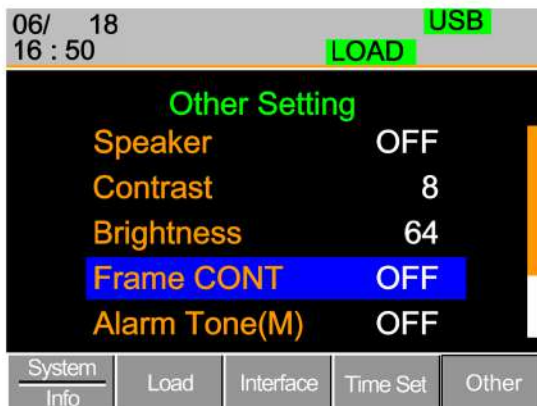
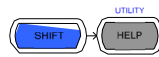

4. Use the selector knob to highlight Frame CONT.

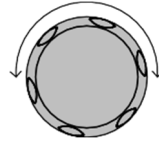

5. Press the selector knob to edit, then turn to turn frame control on or off.

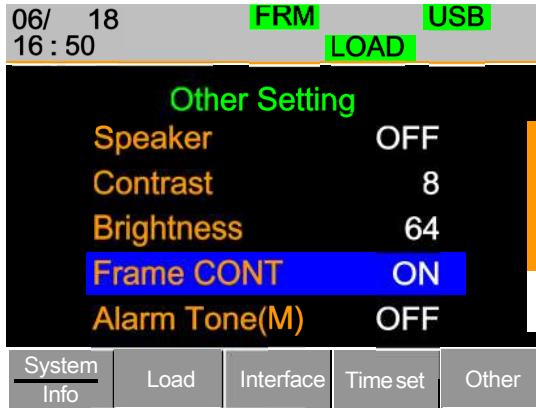
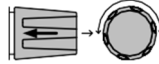

When Frame CONT is set to on, the mainframe displays FRM (master) or FRS (slave) at the top of the display.

6. Repeat the above steps for any connected slave mainframe units.

Frame control is now ready for both master and slave mainframes.

Adjusting the Knob Control Type

Background You can set the mainframe control knob to Update or Old mode.

When set to Update mode, rotating the mainframe knob changes the load module setting value at the same time.

When set to Old mode, rotating the mainframe knob does not change the load module setting value unless you press the knob or Enter key.

Parameter	Knob Type	Updated/old
-----------	-----------	-------------

Panel Operation	1.	Press the Shift key and then the Help key to access the Utility menu.
-----------------	----	---

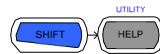

	2.	Press F5 (Other menu).
--	----	------------------------

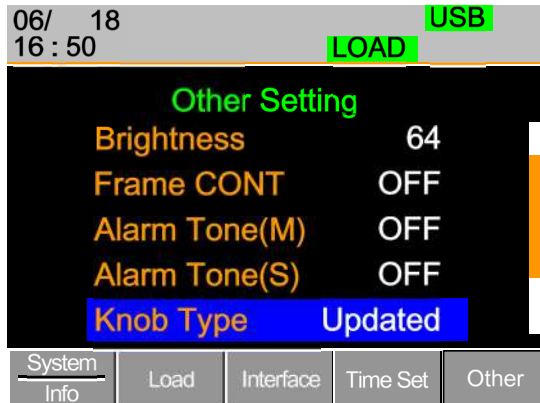

	3.	Use the selector knob to move the cursor down to Knob Type (below the initial screen).
--	----	--

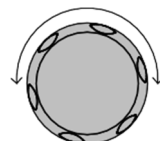

4. Press the selector knob to highlight Knob Type, then turn to change to Old/Updated.

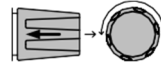

Knob Type Updated

5. Press the selector knob or Enter to confirm the selection.

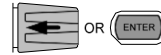

Configuring Alarm Sound

Background The RMX series has two different types of alarms, one on the mainframe (alarm tone M) and one for each load module (alarm tone S).

You can set alarm tones M and S individually to on or off.

Parameter	Alarm Tone (M)	ON/OFF
	Alarm Tone (S)	ON/OFF

- Panel Operation**
1. Press the Shift key and then the Help key to access the Utility menu.
 2. Press F5 (Other menu).

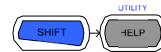

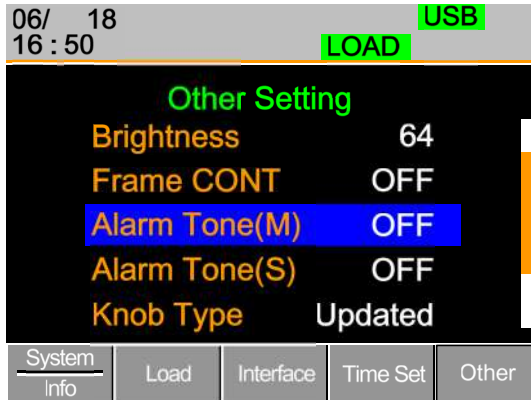

- Use the selector knob to highlight the master alarm, Alarm Tone (M).

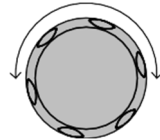

- Press the selector knob to select Alarm Tone (M), turn to edit, and press to confirm the selection.

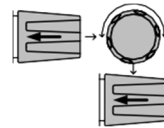

Alarm Tone(M) ON

- Repeat the steps to edit the slave alarm, Alarm Tone(S).

Configuring Go/NoGo Alarm Sound

Background You can set an alarm to sound when any Go/NoGo limits are tripped from any channel.

The Go_NoGo tone alarm settings apply to all channels.

Parameter Go_NoGo Tone On/off

- Panel Operation
1. Press the Shift key and then the Help key to access the Utility menu.
 2. Press F5 (Other menu).

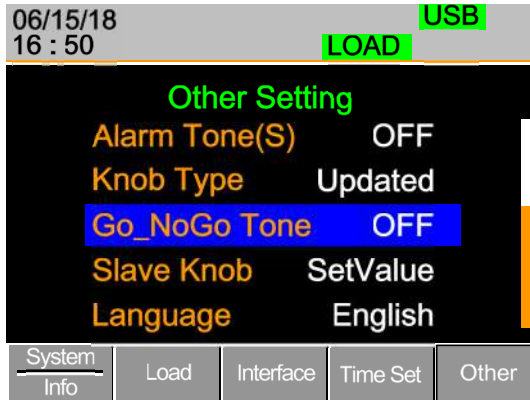
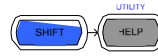

3. Use the selector knob to move the cursor down to Go_NoGo Tone (below the initial screen).

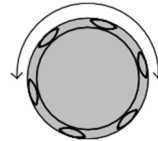

4. Press the selector knob to highlight Go_NoGo Tone, then turn to change to ON/OFF.

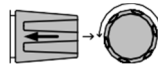

Go_NoGo Tone OFF

5. Press the selector knob or Enter to confirm the selection.

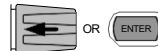

Adjusting Slave Knob Settings

Background You can edit channel loads using the local load module or the mainframe. When using the slave knob to edit a load, you can set the load module display to two different types: SetValue and Measured.

When a load is on, SetValue always displays the set value (A Value, B Value) on the local load module display, while Measure shows the actual measured value when editing the load. These settings apply to all channels.

You can temporarily disable the Measure setting by pressing the slave knob to display the SetValue instead of the Measure value in the local load module display.

Parameter	Slave Knob	Measure/SetValue
------------------	-------------------	-------------------------

Panel Operation

1. Press the Shift key and then the Help key to access the Utility menu.

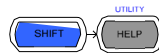

2. Press F5 (Other menu).



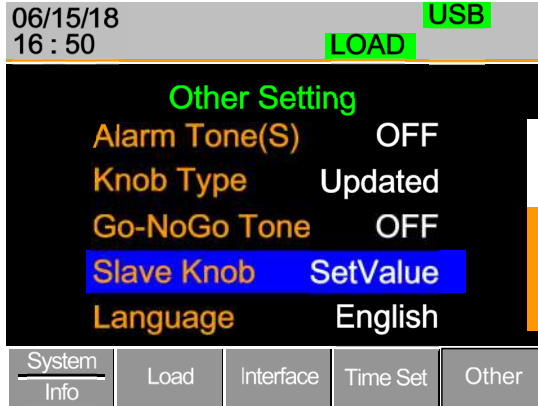

3. Use the selector knob to move the cursor down to Slave Knob (below the initial screen).

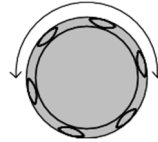

4. Press the selector knob to highlight Slave Knob, then turn to change to Measure/SetValue.

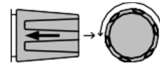

Slave Knob **SetValue**

5. Press the selector knob or Enter to confirm the selection.

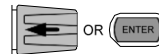

View Language Settings

Background Use the Utilities menu to view the language settings.

Panel Operation 1. Press the Shift key and then the Help key to access the Utility menu.

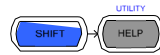

2. Press F5 (Other menu).

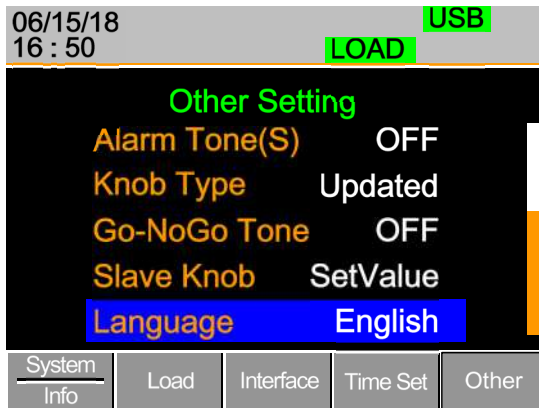

3. Use the selector knob to move the cursor down to Language (below the initial screen).

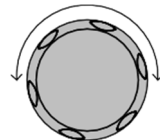

Adjusting the High Resolution

Background ON: When there is a difference between the measured value of the voltage, current, or power displayed on the module panel and the setting value, the system fine tunes the load value so that the measured value is close to the setting value. The system performs and completes this action in 1 second after loading is on.

OFF: The system performs no action when there is a difference between the measured value of the voltage, current or power displayed on the module panel and the setting value.

Parameter	High Resolution	ON/OFF
-----------	-----------------	--------

- Panel operation**
1. Press the Shift key and then the Help key to access the Utility menu.
 2. Press F5 (Other menu).

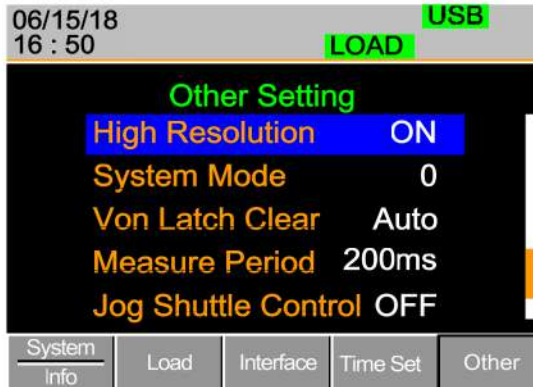
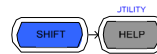

3. Use the Selector knob to highlight High Resolution.

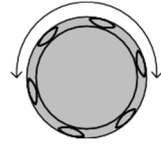

4. Press the Selector knob to edit High Resolution, then turn to change from ON to OFF and vice versa.

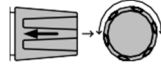

High Resolution

ON

5. Press the Selector knob or Enter to confirm selection.

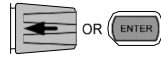

Adjusting the System Mode

- Background**
- 1: When any command is received, the Master panel automatically enterf the Remote fast mode.
 - 0: The Master panel will not enter the Remote fast mode automatically.



Note

For details about remote mode fast/normal, refer to the UTILity:REMOte:MODE command in the programming manual.

Parameters System Mode 0/1

- Panel operation**
1. Press the Shift key and then the Help key to access the Utility menu.
 2. Press F5 (Other menu).

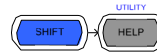

3. Use the Selector knob to highlight System Mode.

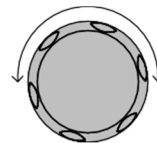

4. Press the Selector knob to edit System Mode, then turn to change from 0 to 1 and vice versa.

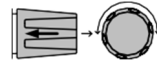

System Mode

0

5. Press the Selector knob or Enter to confirm selection.

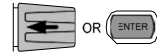

Adjusting the Von Latch Clear

Background

Auto: The load starts when the module terminal voltage exceeds the Von value. The system stops loading when the module terminal voltage is close to 0 V for more than 25 ms, and the system is detecting Von again.

Manual: The load starts when the module terminal voltage exceeds the Von value. Loading continues even if the module terminal voltage is close to 0 V.

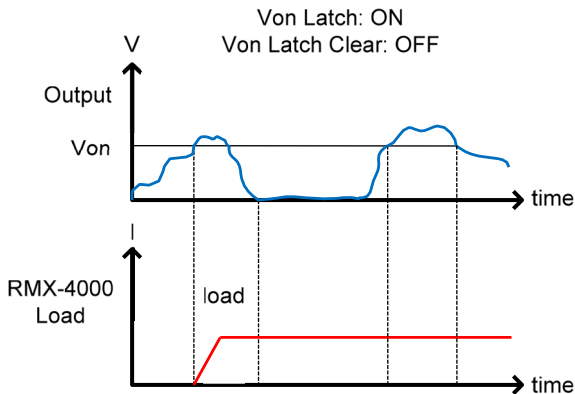
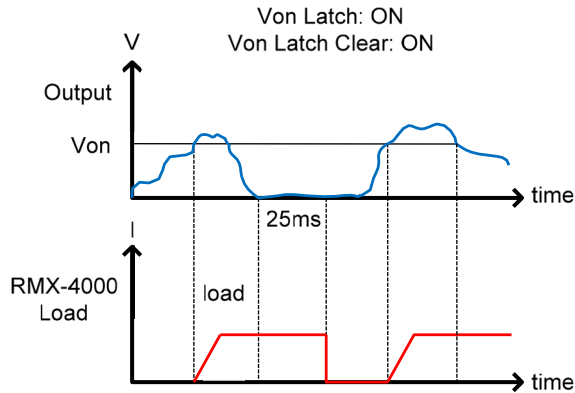



Note

This feature is available only when Von Latch is set to ON.

Parameters Von Latch Clear Auto/Manual

Panel operation 1. Press the Shift key and then the Help key to access the Utility menu.

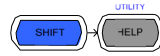

2. Press F5 (Other menu).

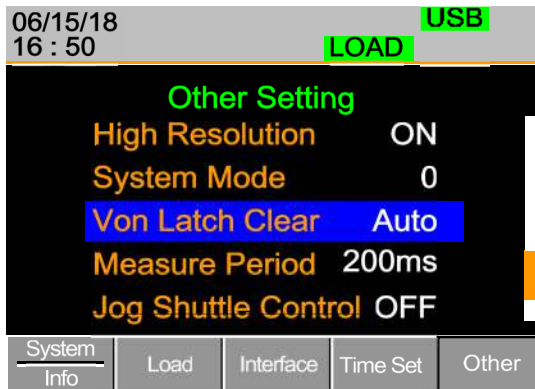

3. Use the Selector knob to highlight Von Latch Clear.

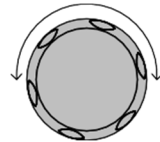

4. Press the Selector knob to edit Von Latch Clear, then turn to change from Auto to Manual and vice versa.

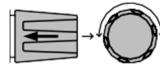

Von Latch Clear Auto

5. Press the Selector knob or Enter to confirm selection.

Adjusting the Measure Period

Background Use this setting to select a measure sample rate. Rates of 200 ms or 20 ms are available for voltage and current sampling rate.

Parameter Measure Period 200 ms/20 ms

Panel operation 1. Press the Shift key then the Help key to access the Utility menu.

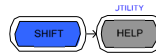

2. Press F5 (Other menu).

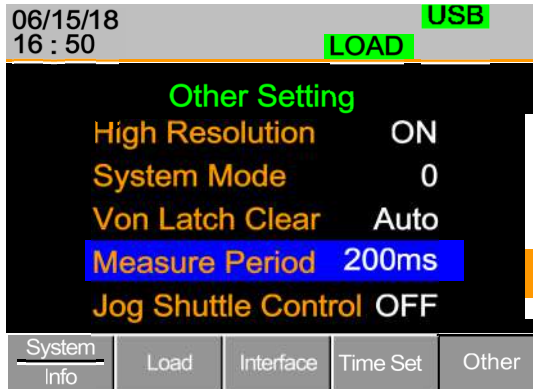

3. Use the Selector knob to highlight Measure Period.

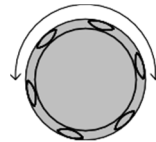

4. Press the Selector knob to edit Measure Period, then turn to change from 200 ms to 20 ms and vice versa.

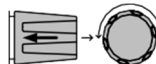

Measure Period 200ms

5. Press the Selector Knob or Enter to confirm selection.



Adjusting the Jog Shuttle Control

Background **ON:** After you enable this setting, the slave knob adjusts the setting value in Jog Shuttle mode when you adjust the setting value. The interval value is adjusted according to the knob speed.

OFF: If you disable this setting, the slave knob adjusts the setting value in the form of fixed compartment when you adjust the setting value.

Parameter	Jog Shuttle Control	ON/OFF
-----------	---------------------	--------

- | | |
|-----------------|--|
| Panel operation | 1. Press the Shift key and then the Help key to access the Utility menu. |
|-----------------|--|

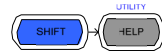

- | | |
|--|---------------------------|
| | 2. Press F5 (Other menu). |
|--|---------------------------|



- | | |
|--|--|
| | 3. Use the selector knob to highlight Jog Shuttle Control. |
|--|--|

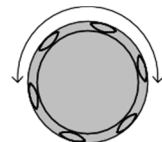

- Press the Selector knob to edit Jog Shuttle Control, then turn to change from OFF to ON and vice versa.

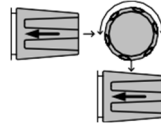

Jog Shuttle Control OFF

- Press the Selector knob or Enter to confirm selection.

Adjusting the RVP Load Off



Background ON: When RVP is detected, Alarm displays on the screen, and loading stops.

OFF: When RVP is detected, Alarm displays on the screen, but loading remains on.



Note

This setting applies to all channels. But each channel independently detects RVP, emits the alarm, and stops the load.

Parameter	RVP Load Off	ON/OFF
Panel operation	<ol style="list-style-type: none"> Press the Shift key and then the Help key to access the Utility menu. Press F5 (Other menu). 	<div style="display: flex; justify-content: space-around; align-items: center;"> <div style="text-align: center;">  </div> <div style="text-align: center;">  </div> </div> <div style="text-align: center; margin-top: 20px;">  </div>

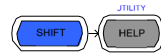



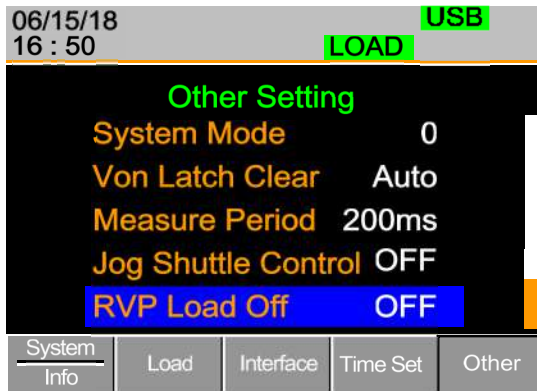

3. Use the Selector knob to highlight RVP Load Off.

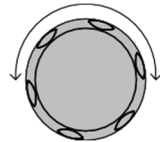

4. Press the Selector knob to edit RVP Load Off, then turn to change from OFF to ON and vice versa.

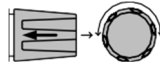

RVP Load Off OFF

5. Press the Selector Knob or Enter to confirm selection.



Setting the Date and Time

Description Use the date and time settings to time stamp files when saving them.

- The date is shown at the top of the display.

Parameters	Month	1-12
	Day	1-31
	Year	1990-2038
	Hour	0-23
	Minute	0-59

Panel operation 1. Press the Shift key then the Help key to access the Utility menu.

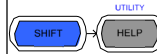

2. Press F4 (Date/Time menu).



Settings: Month, Day, Year, Hour, Minute

06/15/18
16 : 50

RS232
LOAD

Date/Time

Month	6
Day	15
Year	18
Hour	16
Minute	50

System Info | Load | Interface | Time Set | Other

Interface Configuration (Settings)

This chapter describes configuration settings that apply when using the RMX-400x mainframe with a remote connection. There are three interface options for remote control: RS232 and USB. You can use only one interface at a time. For more details about remote control and interface connections, refer to the Interface section on page 311.

Configuring RS232 Connection

Background	When using RS232, you need to set several parameters. These include baud rate, stop bit, and parity. When setting RS232 parameters, ensure that they match those of the host machine.
------------	---

Parameters	Baud Rate	2400/4800/9600/19200/38400
	Stop Bit	1-2
	Parity	None/odd/even

- | | |
|-----------------|--|
| Panel Operation | 1. Press the Shift key and then the Help key to access the Utility menu. |
| | 2. Press F3 (Interface menu). |

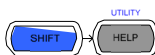

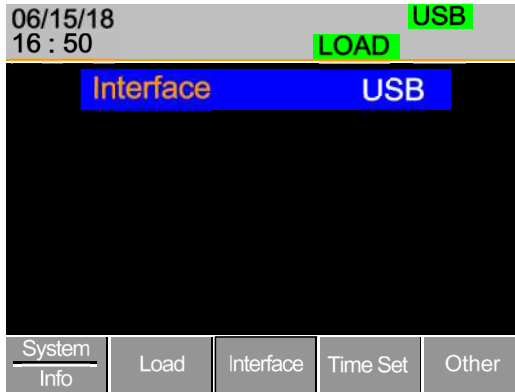

3. If the Interface mode is not RS232, turn the selector knob to RS232.

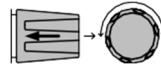

4. Choose RS232.



5. Press the selector knob to confirm.



6. The RS232 menu appears.

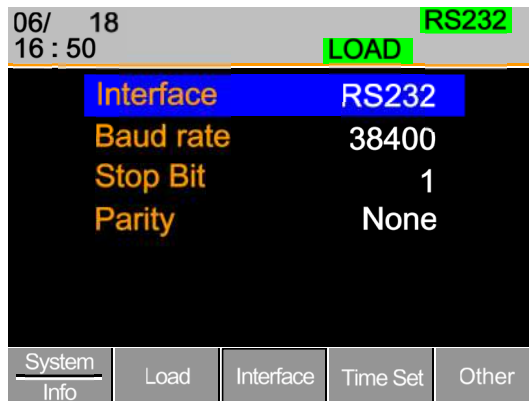

- Use the selector knob to edit Baud rate, Stop Bit, and Parity.

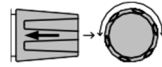

Note

The baud rate, stop bit, and parity must match that of the host machine.

For RS232 function check, refer to the *RS232 and USB CDC Function Check* section on page 263.

Configuring USB Connection

Background Of the three interface options, USB is the easiest to use.

USB connection PC side connection Type A, host
 RMX-4000 side connector Type B, device

Speed 1.1/2.0 (full speed)

Panel Operation 1. Press the Shift key and then the Help key to access the Utility menu.

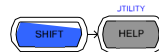

2. Press F3 (Interface Menu).



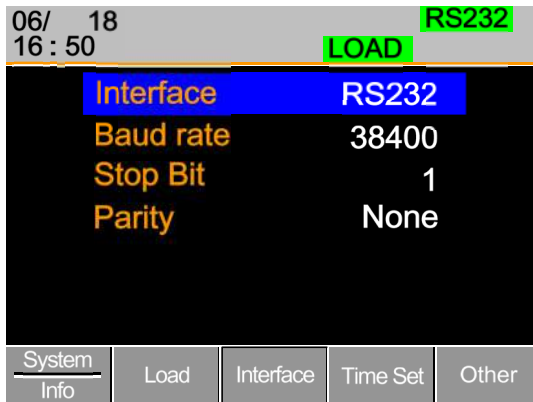

3. If the Interface mode is not USB, use the selector knob to edit Interface.

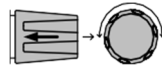

4. Choose USB.



5. Press the selector knob to confirm.

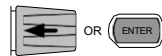

6. The Interface becomes USB.

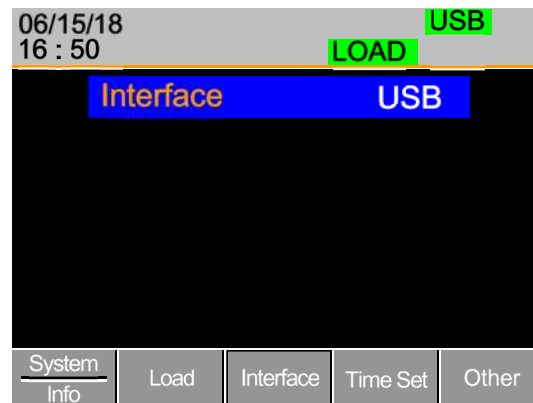

7. Connect the USB cable to the USB-B slave port on the rear.



8. If the PC asks for the USB driver, select RMX-4000.inf (downloadable from the National Instruments website, www.ni.com, RMX-4000 product page).



Note

For USB CDC function check, refer to the *RS232 and USB CDC Function Check* section on page 263.



Configuring Ethernet Connection

Background When using Ethernet, you need to set several parameters including DHCP On/Off, IP Address, Subnet Mask, and Gateway. When setting Ethernet parameters, ensure they match the network parameters.

Parameters	DHCP	On/Off			
	IP Address	0-255	0-255	0-255	0-255
	Subnet Mask	None/Odd/Even			
	Gateway	0-255	0-255	0-255	0-255

Configurat ion This configuration example configures the RMX-4000 socket server.

The following configuration settings manually assign the RMX-4000 an IP address and enable the socket server. The socket server port number is fixed at 2268.

Steps

1. Connect an Ethernet cable from the network to the rear panel Ethernet port. You will see the LED indicator next to Ethernet port turn on.



2. Power on the RMX-4000.
-

Panel operation 3. Press the Shift key and then the Help key to access the Utility menu.

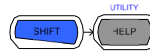

4. Press F3 (Interface menu).

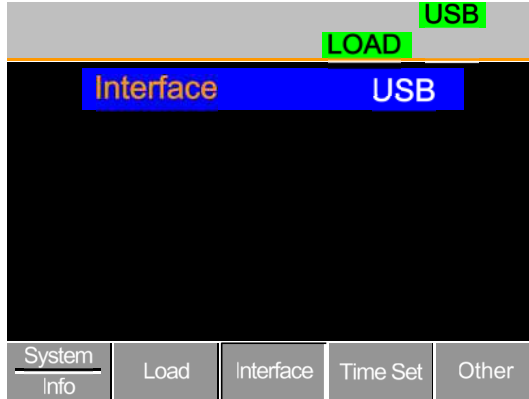

5. If the Interface mode is not Ethernet, use the Selector knob to edit Interface.

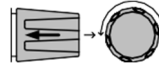

6. Choose Ethernet.



7. Press the Selector knob to confirm.



8. The Ethernet menu appears.

06/15/18	Ethernet			
16 : 50	LOAD			
Interface	Ethernet			
Connection status	Online			
MAC	00-80-2f-20-4e-23			
DHCP	ON			
IP Address	172.	16.	23.	17
Subnet Mask	255.	255.	128.	0
System Info	Load	Interface	Time Set	Other

Use the Selector knob to edit the DHCP, IP Address, Subnet Mask, and Gateway settings.

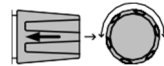

Note

If the DHCP is set to ON, the network DHCP server configures the IP Address, Subnet Mask, and Gateway settings automatically. These settings appear after the RMX-4000 gets the information by DHCP.



Note

If the DHCP is set to OFF, make sure the IP address, Subnet Mask, and Gateway settings match those of the network.

Web Server Function Check

Functionality check

The web server allows you to check the RMX-4000 function settings.

Enter the RMX-4000 IP address in a web browser.

The web browser interface appears.

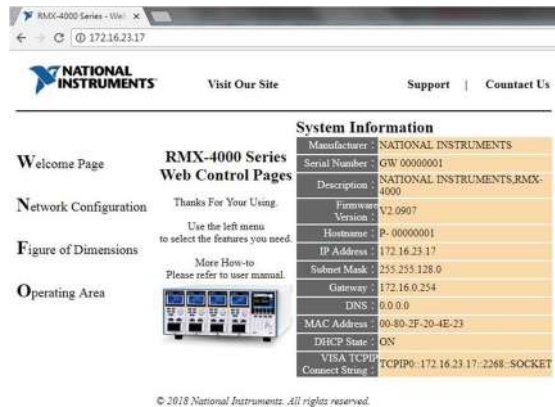

The web browser interface allows you to access the following:

- Network configuration settings
- RMX-4000 dimensions
- Operating area diagram

Click **Network Configuration** to see the configuration information.

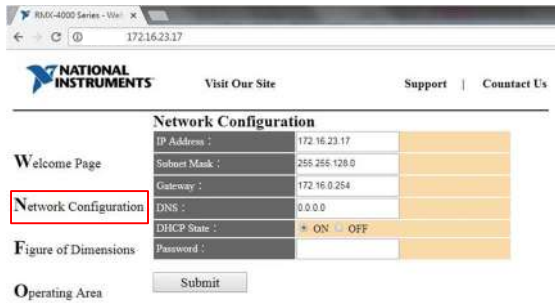

Click **Figure of Dimensions** to see the device dimensions information.

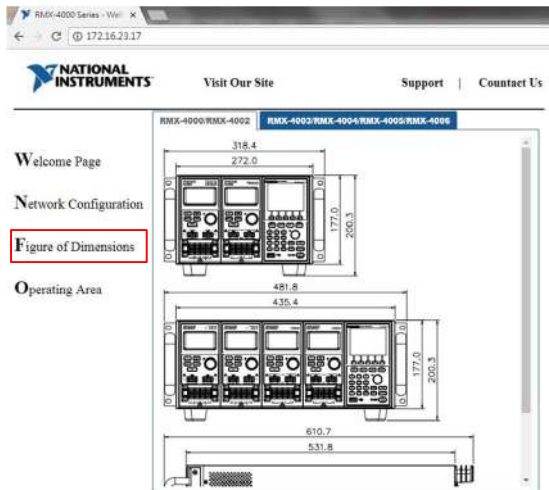

Click **Operating Area** to see the load operating area.

RMX-4000 Series - Web X
172.16.23.17

NATIONAL INSTRUMENTS Visit Our Site Support | Contact Us

RMX-4003 RMX-4004 RMX-4005 RMX-4006

RMX-4003 Low Range 10W

RMX-4003 High Range 100W

Operating Area

RS232 and USB CDC Function Check

Background You can use National Instruments Measurement & Automation Explorer (MAX) to test the RS232 and USB CDC functionality. This program is available on the NI website, www.ni.com, via a search for the VISA runtime engine page, or you can download it at www.ni.com/visa/.

Requirements Operating system: Windows XP, 7, 8, 10



Note

You can perform a functionality check only after connecting the cable and setting the RMX-4000 interface.

Functionality check

1. Start MAX. In Windows, select **Start>>All Programs>>National Instruments>>Measurement & Automation**.
2. In **My System>>Devices and Interfaces** in MAX, select the corresponding port connected to the RMX-4000 via the USB or RS232 interface.
3. In this example (NI MAX Version 18.0.0f0), assume the RMX-4000 is connected to COM 1 (ASRL1). After selecting **ASRL1::INSTR "COM1"**, click **Open VISA Test Panel**.

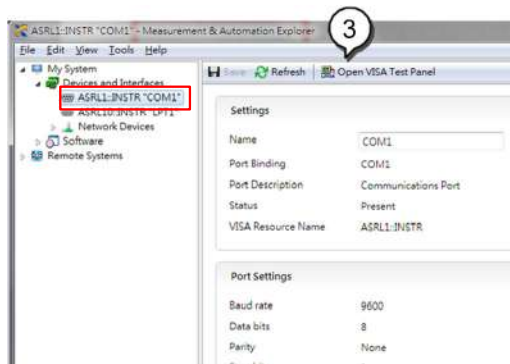

- On the ASRL Settings page, you can see the **Serial Settings** information.

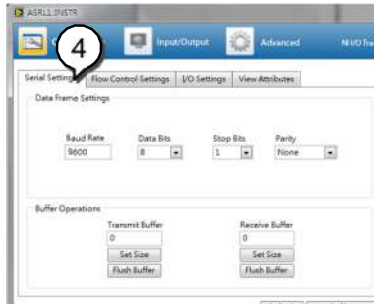

- Click **I/O Settings**.
- Make sure the **Enable Termination Character** check box is checked and the terminal character is `\n` (Value: `xA`).
- Click **Apply Changes**.



- Click the **Input/Output** icon.
- Enter `*IDN?\n` in the **Select or Enter Command** dialog box if it is not already entered.



10. Click the **Query** button.

11. The *IDN?\\n query returns the manufacturer, model name, serial number, and firmware version in the dialog box.

```
NATIONAL\\s INSTRUME, RMX-4002, 00000001, V108\\n
```



Note

The COM port corresponding to the USB CDC exists until the USB driver is installed. To do the USB CDC function check, change the VISA resource name to the COM port that the USB CDC protocol occupies as a virtual COM port in your system.

Socket Server Function Check

Background

You can use National Instruments Measurement & Automation Explorer (MAX) to test the socket server functionality. This program is available on the NI website, www.ni.com, via a search for the VISA runtime engine page, or you can download it at www.ni.com/visa/.

Requirements

Operating system: Windows XP, 7, 8, 10

Functionality check

1. Start MAX. In Windows, select **Start>>All Programs>>National Instruments>>Measurement & Automation**.
2. In MAX, select **My System>>Devices and Interfaces>>Network Devices**.
3. Select **Add New Network Device>>VISA TCP/IP Resource**.



4. Select **Manual Entry of Raw Socket** from the popup window.

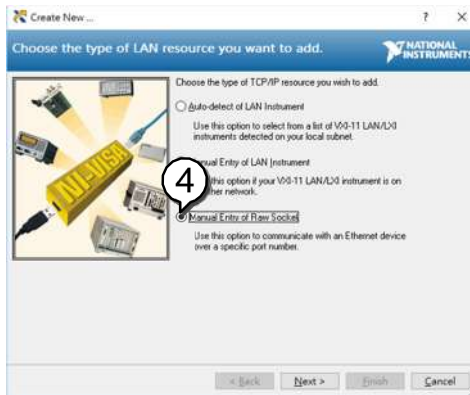

5. Enter the RMX-4000 IP address and port number. The port number is fixed at 2268.
6. Click **Validate**.

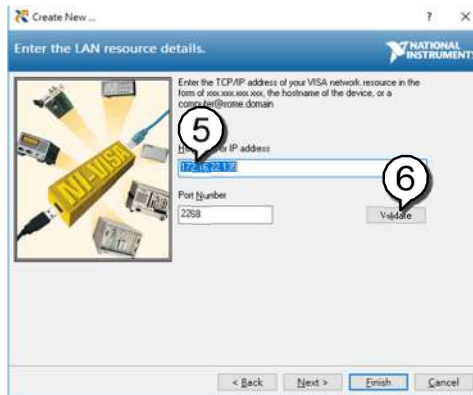

7. A popup appears if a connection is successfully established. If not, check the load device IP address configuration, then click **OK** and **Next**.

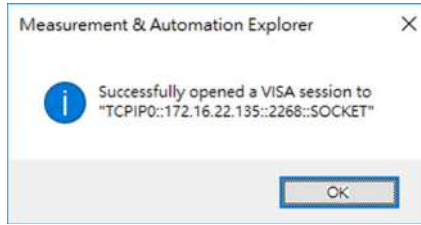

8. Click **Finish**.

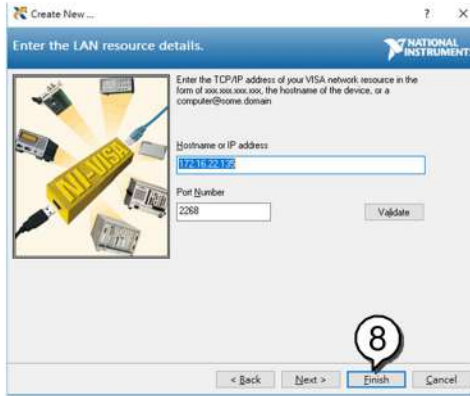

9. You can see that the network device is set up successfully. Click **Open VISA Test Panel**.

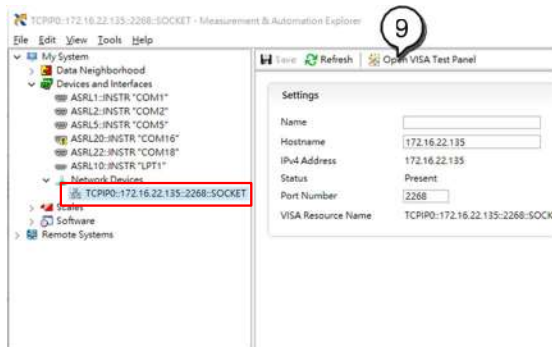

- On the TCP/IP Settings page, you can see the TCP/IP information.

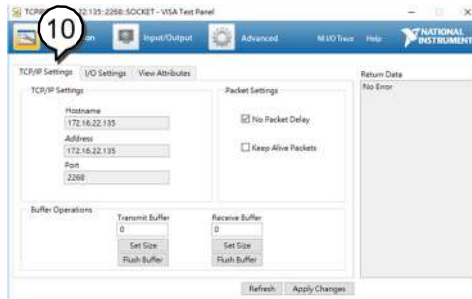

- Click **I/O Settings**.
- Make sure the **Enable Termination Character** check box is checked and the terminal character is `\n` (Value: `xA`).
- Click **Apply Changes**.

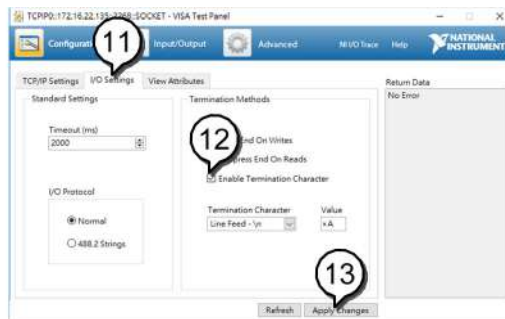

- Click the **Input/Output** icon.
- Enter `*IDN?\n` in the **Select or Enter Command** dialog box if it is not already entered.

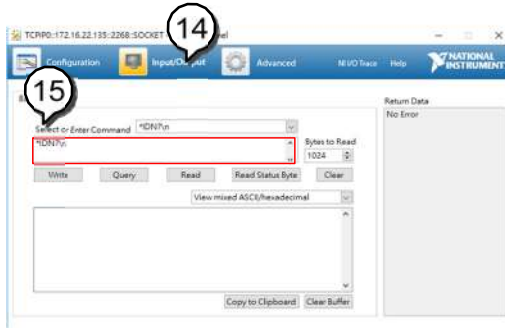

16. Click the **Query** button.

17. The *IDN?\n query returns the manufacturer, model name, serial number, and firmware version in the dialog box.

NATIONAL|sINSTRUME,rMX-4002, \s00000001,
V108\n

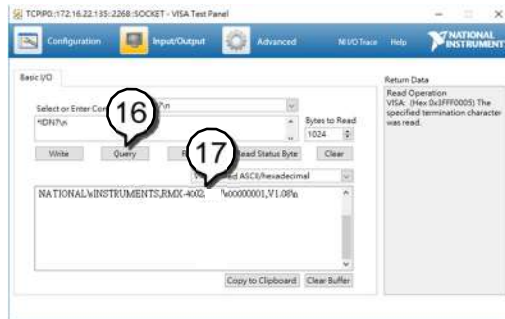

18. Enter the command `:SYST:ERR\n`.

19. Click the **Query** button. You will get an error message.

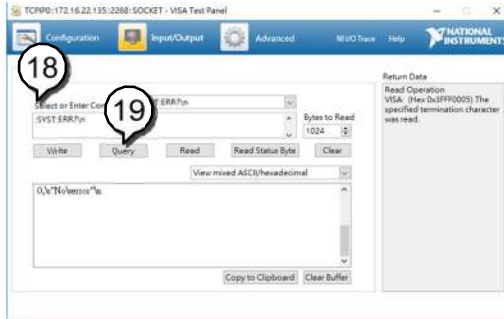

Saving/Recalling Channels

Background The RMX-400x Series can save data for up to 120 channel configurations. Using the onboard memory, 120 memory slots represent each channel.

Program sequences and individual channel setups use memory. For further memory details, refer to page 104.

Panel Operation 1. Press the File key.



2. Press F1 repeatedly until the Media Memory menu appears.



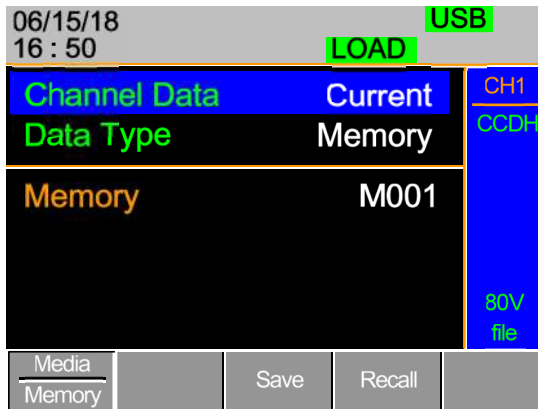

- Use the selector knob to edit Channel Data and Data Type.
- Choose Current or All and Memory.

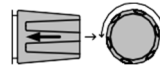

- Press the selector knob to edit Memory (M001-M120)

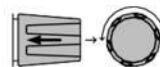

or

Use the number pad to enter a number.



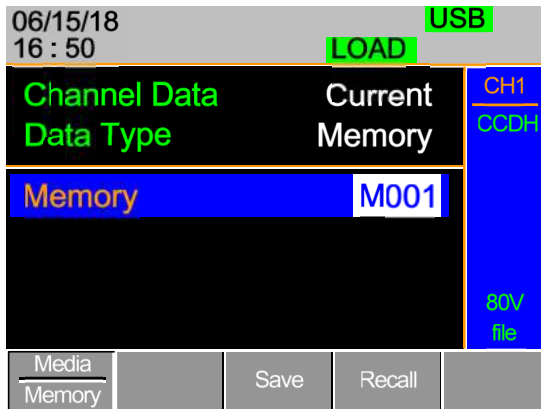

6. Press F3 to Save or F4 to Recall the memory settings.

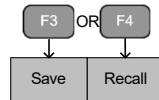

7. A message indicates when a save has been successful.

Memory No 001 Save OK



Note

The display reverts to the channel menu after recalling memory.

Saving/Recalling Preset memory

Background The RMX-400x Series can store up to 10 presets for each channel. You can save or recall the presets either individually for each channel (Channel Data: Current) or at the same time (Channel Data: All), using the All option.

For further memory details, refer to page 104.

Panel Operation 1. Press the File key.



2. Press F1 repeatedly until the Media Memory menu appears.

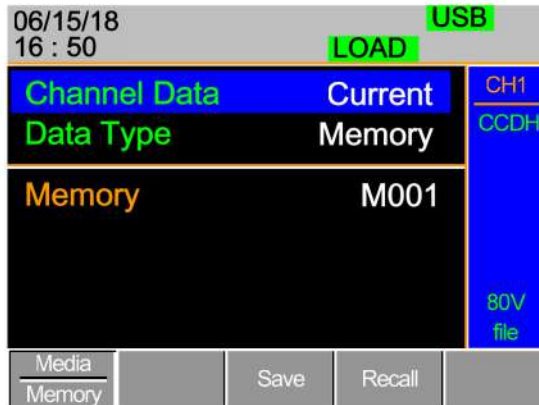
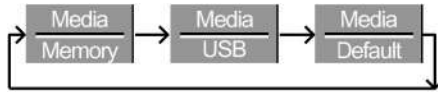

3. Use the selector knob to edit Channel Data and Data Type.

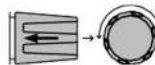

- To save or recall only the active channel, choose Current and Preset. To save or recall all the presets, choose All and Preset.

Save / Recall
Current Channel

Channel Data	Current
Data Type	Preset

Save / Recall All
Channels

Channel Data	All
Data Type	Preset

- Press the selector knob to edit Preset (P0-P9)

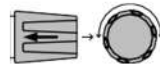

or

Use the number pad to enter a number.

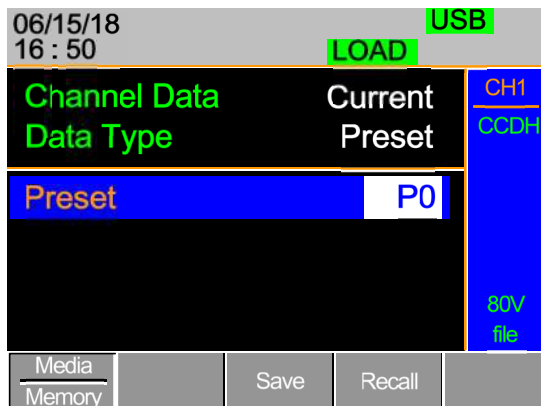
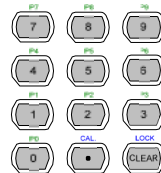

- Press F3 to Save or F4 to Recall the Presets.

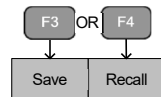

- A message displays when the save is complete.

Preset P0 Save OK

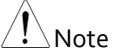

Note

The display reverts to the channel menu after recalling memory.

Saving/Recalling Setup Memory

Background The RMX-400x Series can store up to four setups using the onboard memory. You can save each setup from the file menu. Using Setup Memory saves each channel. For further memory details, refer to page 104.

Panel Operation 1. Press the File key.



- Press F1 repeatedly until the Media Memory menu appears.

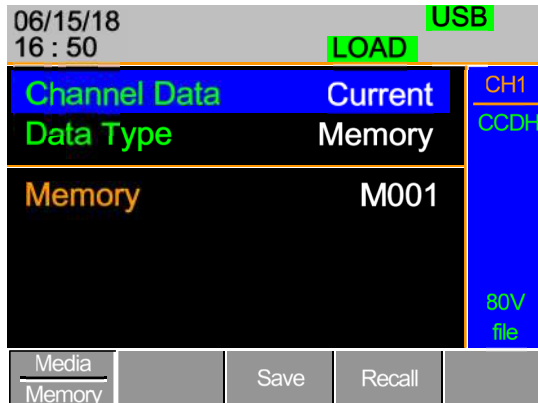

- Use the selector knob to edit Channel Data and Data Type.

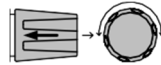

- Choose All and Setup.



- Press the selector knob to edit Setup Memory (1-4)

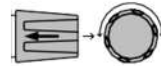

or

Use the number pad to enter a number.

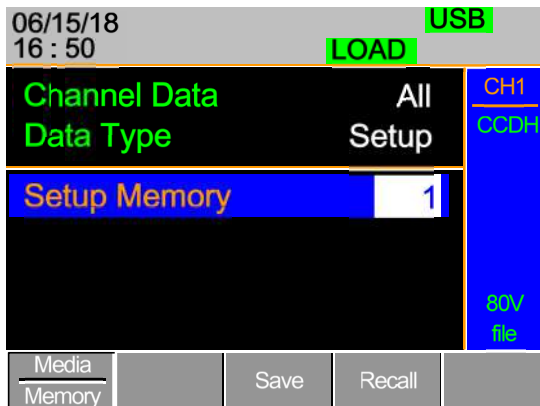
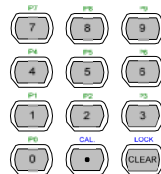

- Press F3 to Save or F4 to Recall the Setup Memory.

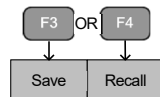



- A message displays when the save/recall is complete.

Setup Memory 1 Save OK Setup Memory 1 Recall OK

Setting the Default USB Path/File

Background When saving files to a USB memory stick, the files are saved into the root directory if a file path has not been set.

- Panel Operation**
1. Insert a USB flash drive into the front panel USB slot. 
 2. Press the File key. 
 3. Press F1 repeatedly until the Media USB menu appears. 



06/15/18 16 : 50	LOAD	USB
Channel Data	Current	CH1
Data Type	Memory	CCDH
Save File	4004L_00.M	80V file
Recall File	P0200_00.M	
Path: usb:		
Media USB	Save	Recall
		File Utility

4. Press F5 (File Utility). 



The top section (window) shows the current USB path.

There are four options:

- **Select** – Selects the current USB path as the default file path to save (Step 5).
- **New Folder** – Creates a new folder (Step 7).
- **Rename** – Renames the current folder/path (Step 13).
- **Delete** – deletes the current file/path name. (Step 20).

Select Default Path

5. Use the selector knob to highlight the new path directory

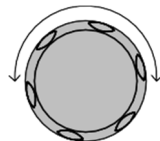

6. Press F1 (Select) to select the new default directory path.





The new path is shown in the upper Path box in green.

Path: usb\New folder

Create New Folder

- To create a new directory, Press F2 (New Folder)



The onscreen keyboard (OSK) appears. The directory has an eight-character size limit.



- Use the selector knob to scroll left and right through the keys.

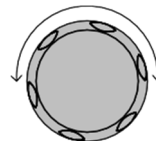

9. When a key is highlighted, use the selector knob, F1, or Enter to confirm a key entry.

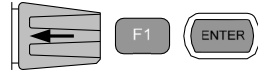

10. Use F2 (backspace) to delete any previous entries/mistakes.



11. Press F3 (save) to save the directory name.



12. Press F5 (previous menu) to continue to the previous menus.



Rename Folder

13. Use the selector knob to highlight the file/directory that you need to rename.

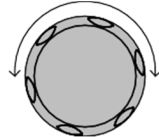

14. Press F3 (Rename).



The onscreen keyboard appears



15. Use the selector knob to scroll left and right through the keys.

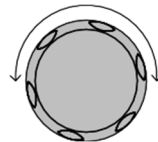

16. When a key is highlighted, use the selector knob, F1, or Enter to confirm a key entry.

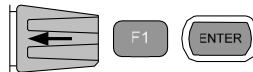

17. Use F2 (backspace) to delete any previous entries/mistakes.
18. Press F3 (save) to save the directory name.
19. Press F5 (previous menu) to continue to the previous menus.



- Delete Filename 20. Use the selector knob to highlight a file/ directory.

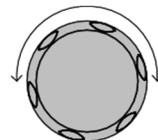

21. Press F4 (delete).





Note

If there is any content in the folder, you cannot delete it and the message **Error! This folder may be not empty!** will be displayed on the screen.

22. To confirm deletion, press F4 again.

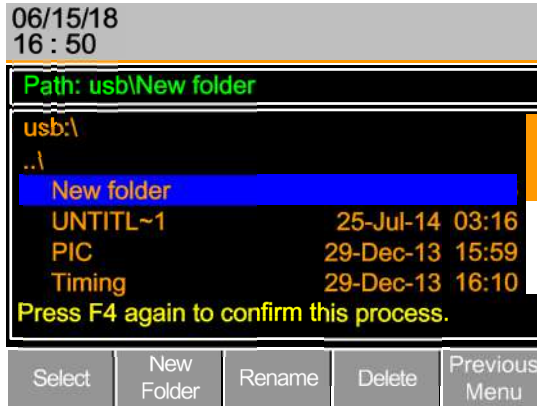

Saving Setups to USB Memory

Background Setup data contains all channel data including memory, presets, and program sequences.

There are four setups in internal memory. When saving to USB, save all four setups. Conversely, when recalling, recall all four setups to main memory.

The file extension *.S is for Setup data only.

Parameters	Save File	400X_XX.S
------------	-----------	-----------

Panel Operation 1. Insert a USB flash drive into the front panel USB slot.



2. Ensure that the USB path is set. Refer to page 278.

3. Press the File key.



4. Press F1 repeatedly until the Media USB menu appears.

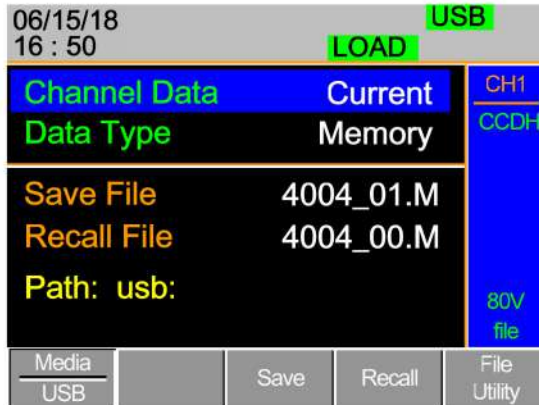
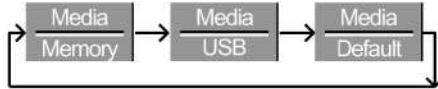

5. Use the selector knob to edit Save Chan and Data Type.

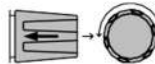

6. Choose All and Setup.



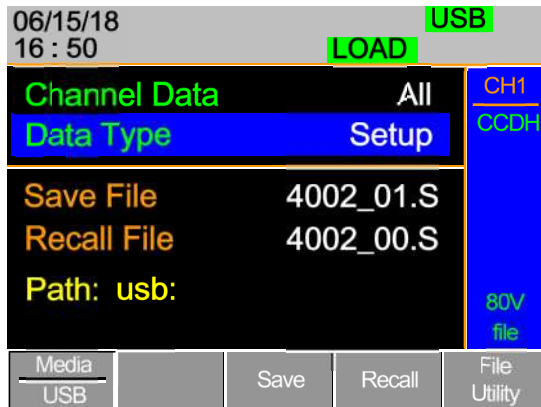

The screen updates to show only Setup files (*.S) available to save/recall in the root directory. Press F5 (File Utility) to select the directory to save.

Save/Recall Setups to USB

7. Use the selector knob to edit Save File or Recall File. Rotating the selector knob scrolls through all available setup files (*.S).
8. Choose a filename (20XXX_XX.S).
9. Press F3 (Save) to save the setup data or F4 (Recall) to recall the setup data.
10. A screen message appears when the save/recall is complete.

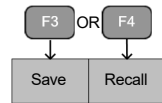
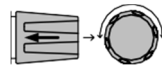

400X_01.S Save Ok
400X_00.S Recall Ok



Note

You can save setups only if you have saved them to internal memory first. For details on how to save to internal memory, refer to page 274.

Saving/Recalling Memory Data to USB

Background There are two options to save memory data to a USB flash drive:

Save Chan Current: Saves the active channel's memory data (M001-M120) to the root directory (400X_XX.M). Press F5 (File Utility) to select the directory to save.

Save Chan All: Saves every channel's memory data (CH1 M001-120 to CH8 M001-M120) to a directory (ALL00XX) as separate files for each channel (P0X0X_C1.M-P0X0X_C8.M).

Recall File: Recalls the selected file to the active channel's memory (MXXX). You cannot update all channels at once; you can recall only one channel at a time.

The file extension *.M is for memory data only.

For more information about the file structures, refer to page 104.

Parameters	Save Channel Data: Directory ALL0000-ALL0099 All File: 400X_CX.M Save Channel Data: File: 400X_CX.M Current Recall Channel File: 400X_CX.M Data: Current
-------------------	--

Panel Operation 1. Insert a USB flash drive into the front panel USB slot.



2. Ensure that the USB path has been set. Refer to page 278.

3. Press the File key.



4. Press F1 repeatedly until the Media USB menu appears.

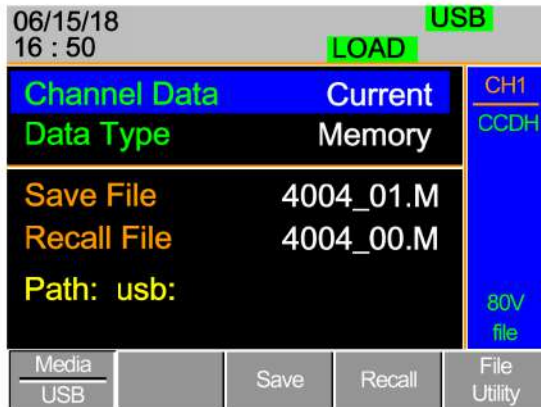
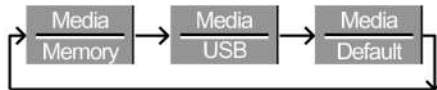

- Save all Channels 5. Use the selector knob to edit Save Chan and Data Type.

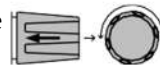

6. Choose All and Memory



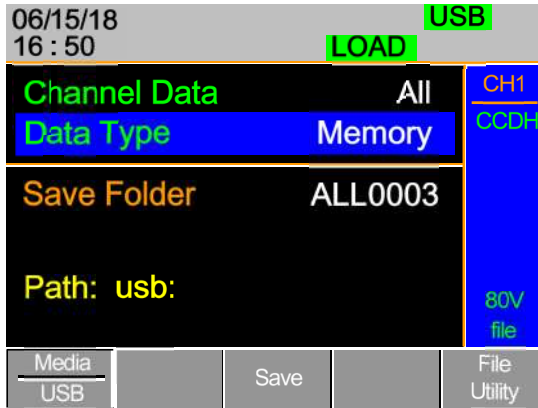

The screen updates to show Save Folder. Note that you cannot recall all channels at once; you can only save them.

- Use the selector knob to edit Save Folder.

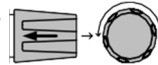

- Choose a directory name (ALL0000-ALL0099).

Save Folder ALL0003



Note

Used directories are not available. You cannot overwrite older directories. You must delete them first.

- Press F3 (Save).



- A screen message displays when complete.

ALL0003 Save Ok

Save /Recall File

- Use the selector knob to edit Save Chan and Data Type.

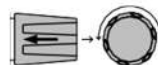

- Choose Current and Memory.

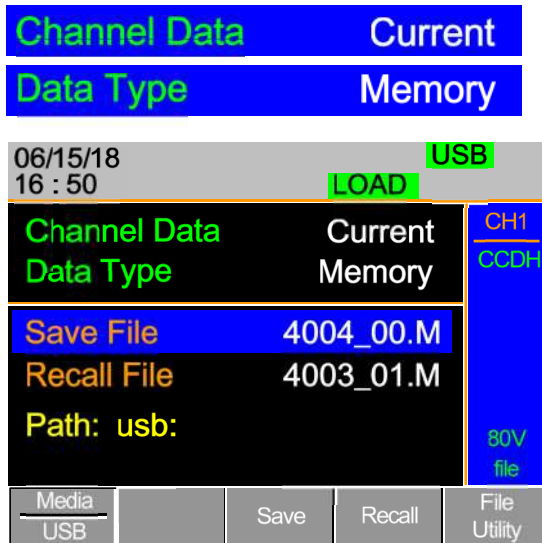

13. Use the selector knob to edit Save File or Recall File.
14. Choose a filename.
15. Press F3 (Save) to save or F4 (Recall) to recall the current channel memory.
16. A save or recall message displays when complete.

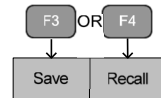

4004_00.M Save Ok
4004_00.M Recall Ok

Recall File from
USB Path

17. Press F5 (File Utility).
18. Use the selector knob to select path for saving memory: usb:\ALLXXXX\File: 400X_XX.M.



19. Press the selector knob, Enter or F1.
20. A recall message displays when complete.



Note

Remember that only the data you saved to internal memory is saved to USB. Only the active channel is saved.

If you try to recall data that originated from a load module different than the active channel, an error message appears. The filename must reflect the active channel's load module type.

Machine Type Error

Saving/Recalling Presets to USB

Background There are two options to save channel presets to a USB flash drive:

Save Chan Current: Saves the active channel's presets (P0-P9) into the root directory (400X_XX.P). Press F5 (File Utility) to select the directory to save.

Save Chan All: Saves every channel's presets (CH1 P0-P9 - CH8 P0-P9) into a directory (ALL00XX) as separate files for each channel (400X_C1.P-400X_C8.P).

Recall: Recalls the selected file to the active channel's presets (P0-P9). You cannot update all channels at once; you can recall only one channel at a time.

The file extension *.P is for channel Presets only.

For more information about the file structures, refer to page 104.

Parameter	Save Channel Data: All	Directory: ALL0000-ALL0099
		File: 400X_CX.P
	Save Channel Data: Current	File: 400X_XX.P
	Recall Channel Data: Current	File: 400X_XX.P

Panel Operation 1. Insert a USB flash drive into the front panel USB slot.



2. Ensure that the you have set the USB path. Refer to page 278.

3. Press the File key.



4. Press F1 repeatedly until the Media USB menu appears.

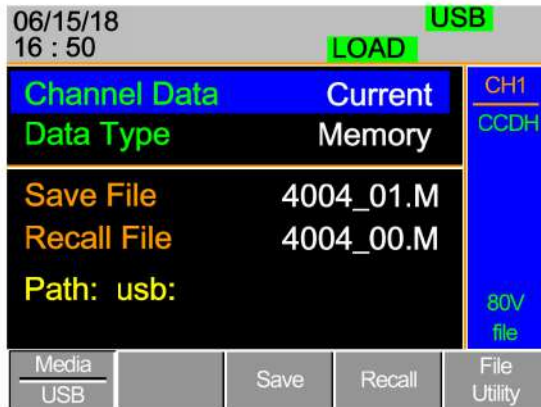
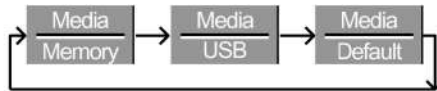

Save all Channel Presets

5. Use the selector knob to edit Save Chan and Data Type.

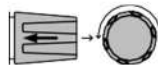

6. Choose All and Preset



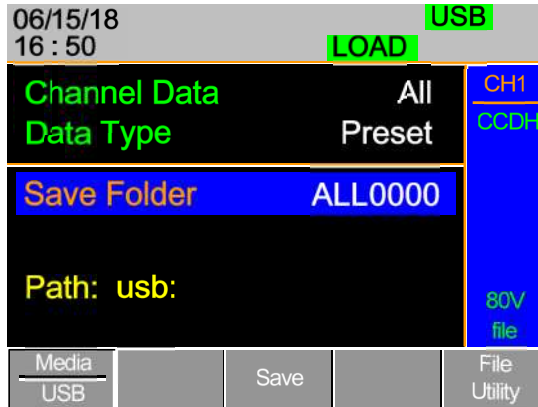

The screen updates to show Save Folder. Note that you cannot recall all presets at once; you can only save them.

7. Use the selector knob to edit Save Folder.

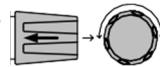

8. Choose a directory name (ALL0000-ALL0099).

Save Folder ALL0000



Note

Used directories are not available. You cannot overwrite older directories. You must delete them first.

9. Press F3 (Save)



10. A screen message displays when the save is complete.

ALL0001 Save Ok

-
- Save/Recall Preset 11. Use the selector knob to edit (current channel) Save Chan and Data Type.

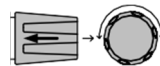

12. Choose Current and Preset.

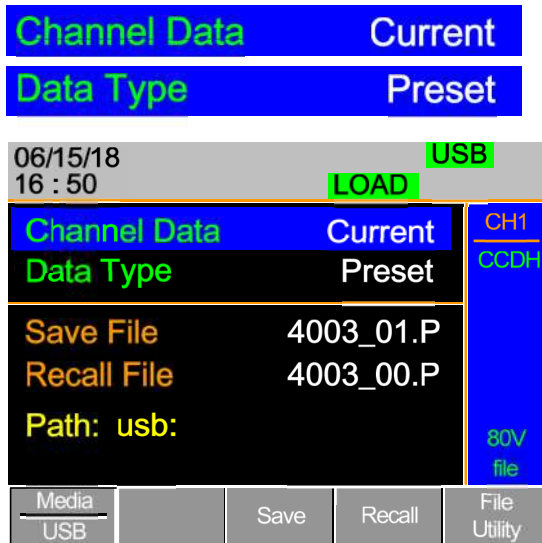

13. Use the selector knob to edit Save File or Recall file.

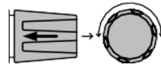

14. Choose a filename.

15. Press F3 (Save) to save or F4 (Recall) to recall the channel presets.

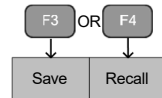

16. A message displays when the save or recall has completed.

4003_01.P Save Ok
4003_01.P Recall Ok

Recall File from
USB Path

17. Press F5 (File Utility).
18. Use the selector knob to select path for saving preset: usb:\ALLXXXX\File: 400X_XX.P.



19. Press the selector knob, Enter, or F1.
20. A recall message displays when complete.



Remember that only data you have saved to internal memory is saved to USB. Only the active channel presets are saved.

If you try to recall data that originated from a load module different than the active channel, an error message appears. The filename must reflect the active channel's load module type.

Machine Type Error

Saving/Recalling Sequences to USB

Background

There are two options to save sequences to a USB flash drive. You can save sequences from either all channels or the current channel only.

Save All: All channels' sequences are saved to a directory (ALL00XX) as separate files for each channel (400X_C1.A-400X_C8.A).

Save Current: The current channel's sequence is saved to the root directory (400X_XX.A). Press F5 (File Utility) to select the directory to save.

Recall: You can recall sequences for only the current channel. You cannot recall all channels' sequences at once.

The file extension *.A is for sequences only.

For more information about the file structures, refer to page 104.

Parameters

Save Channel Data: Directory: ALL0000-ALL0099
 Current File: 400X_C1.A

Save Channel Data: File: 400X_XX.A
 Current

Recall Channel File: 400X_XX.A
 Data: All

Panel Operation

1. Insert a USB flash drive into the front panel USB slot.
2. Ensure that the USB path has been set.



Refer to page 278.

3. Press the File key.



4. Press F1 repeatedly until the Media USB menu appears.

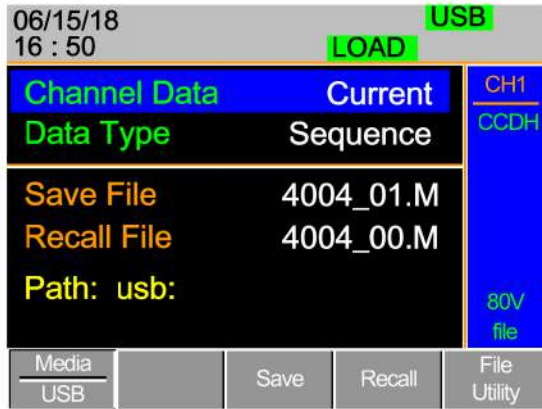
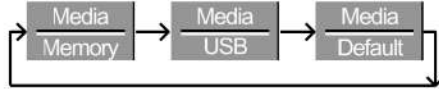

Save all Channel SEQ

5. Use the selector knob to edit Save Chan and Data Type.
6. Choose All and Sequence.

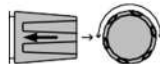

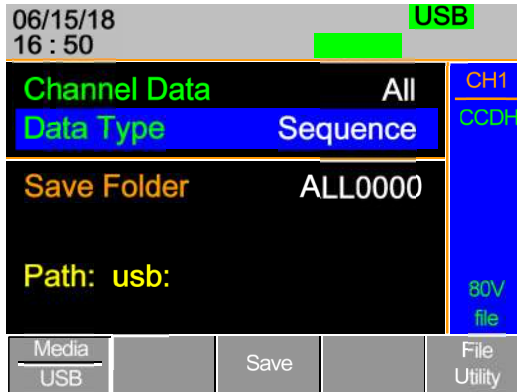

The screen updates to show Save Folder. Note that you cannot recall all Sequence data at once; you can only save it.

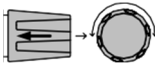
7. Use the selector knob to edit Save Folder. 
8. Choose a directory name (ALL0000-ALL0099).

Save Folder ALL0000



Note

Used directories are not available. You cannot overwrite older directories. You must delete them first.

9. Press F3 (Save) 
10. A screen message displays when saving.

Save All Chan in ALL0000

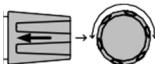
-
- Save/Recall SEQ (current channel)
11. Use the selector knob to edit Save Chan and Data Type. 
 12. Choose Current and SEQ.

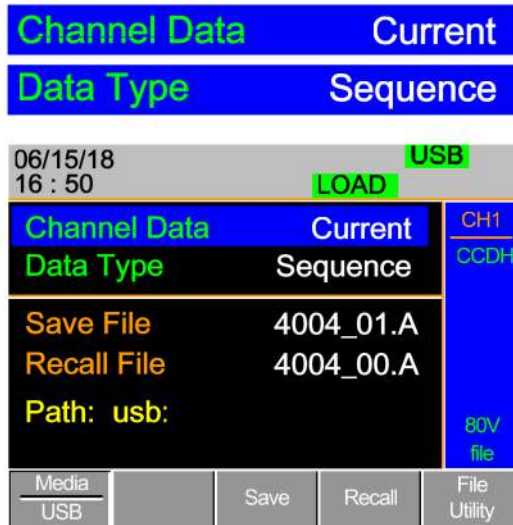

13. Use the selector knob to edit Save File or Recall File.
14. Choose a filename.
15. Press F3 (Save) to save or F4 (Recall) to recall the current channel's sequence.
16. A message displays when you save/recall the file.

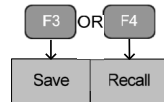

4004_01.A Save OK
4004_01.A Recall OK

Recall File from
USB Path

17. Press F5 (File Utility).
18. Use the selector knob to select path for saving sequence: usb:\ALLXXXX\File: 400X_XX.A.



19. Press the selector knob, Enter, or F1.
20. A recall message displays when complete.



Note

Remember that you must save a sequence to the internal buffer before you can save it to USB.

If you try to recall data that originated from a load module different than the active channel, an error message appears. The filename must reflect the active channel's load module type.

Machine Type Error

Quick Preset Recall/Save

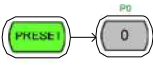
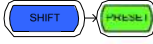
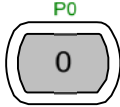
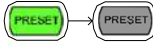
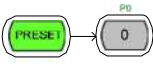
Background	The RMX-400x Series mainframes have up to 10 channel presets (P0-P9). Quick recalling or saving presets applies to only the active channel. For example, P1 on CH1 is not the same as P1 on CH2.	
Parameter	Presets P0-P9 (current channel)	
Panel Operation	<ol style="list-style-type: none"> Remove any USB devices from the front panel. Select the channel to which you want to save channel presets. 	Refer to page 136.
Save Current Channel Preset	<ol style="list-style-type: none"> To save a channel preset, press the Preset key and hold any number key (0-9) for a short time until you hear a beep. 0 = P0, 1= P1, etc. 	
Save All Channel Presets	<ol style="list-style-type: none"> To save all channel presets, press the Shift and Preset keys and hold any number (0-9) for a short time until you hear a beep. 0 = P0, 1= P1, etc. Press the Preset key again to deactivate it. 	  
The preset is saved to the one of 10 presets depending on the number you chose.		
Recall Current Channel Preset	<ol style="list-style-type: none"> Press the Preset key and any number key. 0 = P0, 1= P0, etc. 	
Only the current channel preset is recalled.		

Recall All Channel Presets 7. Press the Shift and Preset keys and any number key.

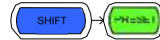

0 = P0, 1= P0, etc.

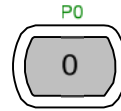

8. Press the Preset key again to deactivate it.

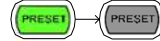

Only the active channel's channel preset is recalled.

Recall Setup Memory (Frame Link).

Background A master mainframe can command all mainframes (master and slave) to recall setup memory from their internal memory. No setup data is recalled from the master mainframe to the slave units.

Parameter Setup memory 1-4.

Panel Operation 1. On the master mainframe, follow the procedure for recalling setup memory for all channels. Refer to page 276

All mainframes update setup memory on recall.



Note

You must save setup data before recalling both master and slave. If you do not save the setup data first, there will be no value change after recalling.

Recall Preset Memory (Frame Link)

Background A master mainframe can command all units to recall preset memory from their internal memory. You can recall only the first three preset memories (P0-P2).

You can recall channel presets via the file menu or using the quick recall feature using the number pad.

Parameters Presets P0-P2 (current channel)

Panel Operation: 1. Remove any USB devices from the front panel.

Quick Keys

2. On the master mainframe, press the Shift and Preset keys.

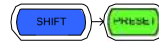

3. Press any number key (0-2).
0 = P0, 1 = P1, etc.

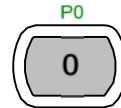

The screen flashes momentarily when the presets are recalled.

Panel Operation: 4. On the master mainframe, follow the procedure to recall preset memory for all channels.

File menu

Refer to page 274

The screen flashes momentarily when the presets are recalled.



Note

You must save preset data before recalling both master and slave. If you do not save preset data first, the value after recalling will be the factory default setting.

Recall Factory/User's Defaults

Background You can save or recall the factory/user's defaults at any time. For details about the factory defaults, refer to the default settings in the appendix, page 331.

Panel Operation 1. Press the File key.



2. Press F1 repeatedly until the Media Default menu appears.

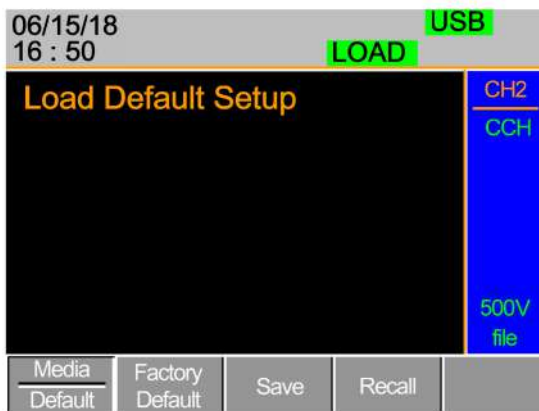
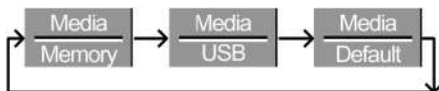

3. Press Factory Default (F2) to recall the factory default settings.





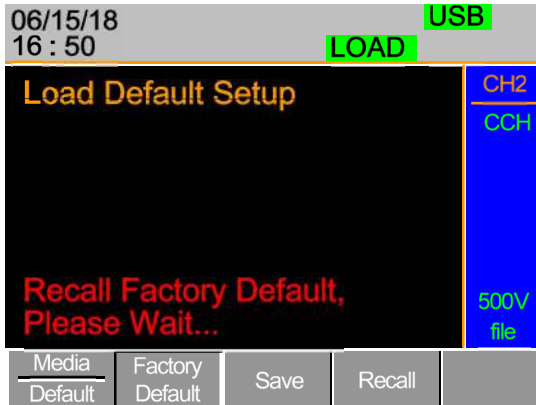

4. Press F2 again to ensure recall factory default setting.



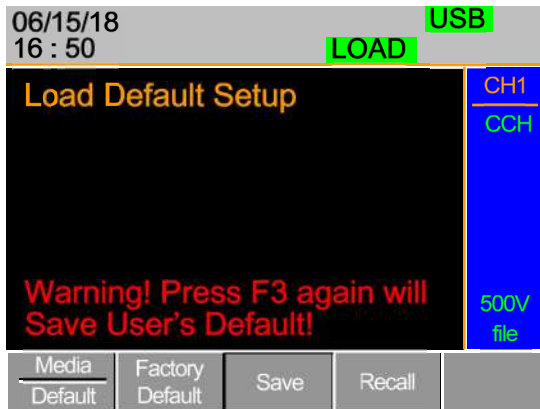

5. Wait a short time for the settings to be recalled.
6. Press Save (F3) to save the user's default.



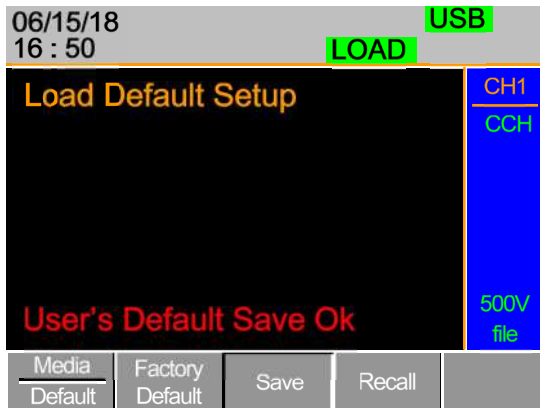

7. Press Save (F3) again to ensure saving the user's default. 
8. Wait a short time for the settings to be saved.



9. Press Recall (F4) to recall the user's default. 



10. Press Recall (F4) to ensure recalling the user's default



11. Wait a short time for the settings to be saved.

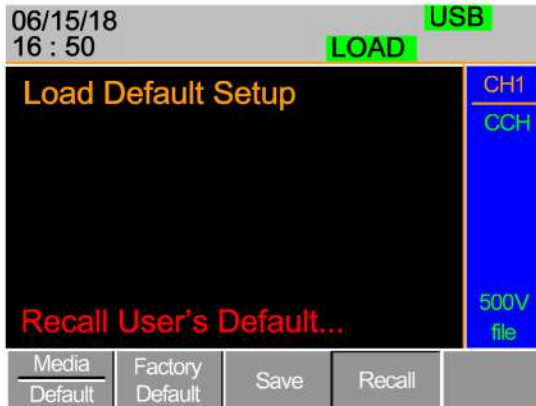

I N T E R F A C E

This chapter details the pin configuration of the RS232, frame link, channel control and go/nogo interfaces.

Interface Configuration	312
Configure RS-232C Interface	312
Configure Channel Control Interface	313
Configure Frame Link Interface	315
Configure Go/NoGo Interface.....	318
USB Interface Connection	319

Interface Configuration

Configure RS-232C Interface

RS-232C Configuration	Connector	DB-9, male
	Baud rate	9600
	Parity	None
	Data bit	8
	Stop bit	1

Connect the RS232C cable (National Instruments part no. GTL-232) to the rear panel port: DB-9 male connector.

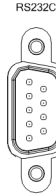

Pin Assignment

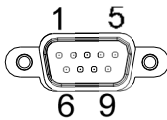

- 2: RxD (Receive data)
- 3: TxD (Transmit data)
- 5: GND
- 1, 4, 6, 7, 8, 9: no connection

PC Connection

Use the null modem connection as shown in the diagram below.

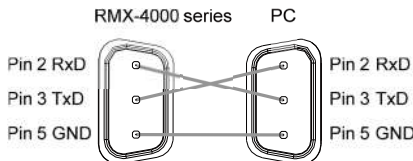

Configure Channel Control Interface

Channel Control Configuration	Connector	Screwless connector.
	Wire gauge	22-28 AWG (24 AWG recommended).
	Wire connection	10 mm strip gauge for connection.

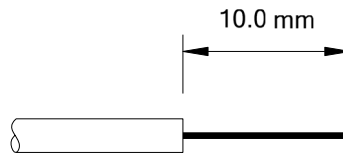

Input	0-10V.
-------	--------

Pin Assignment



1 GND	Negative potential of the load input terminal.
2 I MON (OUTPUT)	Load input current monitor; where 0 V = 0% of input current and 10 V = 100% of input current.
3 V MON (OUTPUT)	Load input voltage monitor; where 0 V = 0% of input voltage and 10 V = 100% of input voltage.
4 Ext Voltage ref (INPUT)	External voltage reference, where 0 V = 0% of rating voltage/current and 10 V = 100% of rating voltage/current. The external voltage reference is for CC and CV mode.

5 Load On

Load On Input.

Load on = Active low.

Load off = Active high. (Pin 5 of the connector is internally pulled up to 3.3 V with a 10 k Ω resistor when the switch is open. Thus, when the switch is open, pin 5 is logically high. When the switch is closed, pin 5 is pulled down to the GND ground level, making pin 5 logically low.)

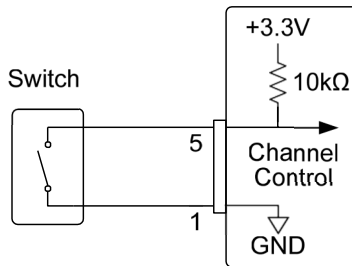

Load On/Off determines whether the external switch is closed (low) or open (high).

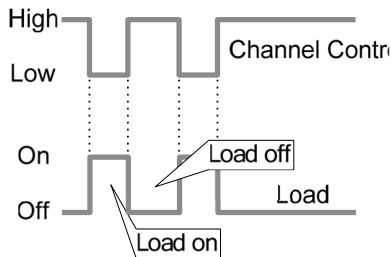

6 +15V

Internal power output. Max 50 mA.

Channel Control Interface Constraints	Mode/Range	You can select mode and range configuration via only the front panel.
---------------------------------------	------------	---

Configure Frame Link Interface

Connection Connect the frame link cable (MIL 20 pin connector) to the rear panel port: 20-pin male connector.

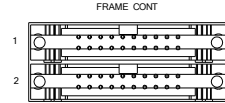

Pin Assignment (Frame Link Connector 1)

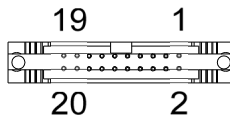

Pin Number	Pin Name	Description
Pin1	A	Input, Recall Preset memory 0 (all channels)
Pin2	B	Input, Recall Preset memory 1 (all channels)
Pin3	C	Input, Recall Preset memory 2 (all channels)
Pin4	Reserved	Reserved
Pin5	MEM_1	Input, Recall Setup memory 1 (all channels)
Pin6	MEM_2	Input, Recall Setup memory 2 (all channels)
Pin7	MEM_3	Input, Recall Setup memory 3 (all channels)
Pin8	MEM_4	Input, Recall Setup memory 4 (all channels)

Pin9	Enable	Input, Enable Load (On/Off), recall Preset memory (0-3) and Setup memory (1-4)
Pin10	Load On/Off	Input, Load On/Off
Pin11	NC	No connection
Pin12	NC	No connection
Pin13	NC	No connection
Pin14	NC	No connection
Pin15	Load Status	Output, load on status
Pin16	Alarm Status	Output, alarm activated
Pin17	+5V	Power source output, +5V, 100 mA
Pin18	NC	No connection
Pin19	GND	Ground
Pin20	GND	Ground

Pin assignment
(Frame link
connector 2)

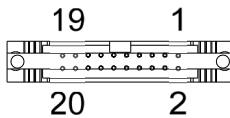

Pin Number	Pin Name	Description
Pin1	Sync._A	Output, Sync signal, Recall Preset memory 0 (all channels)
Pin2	Sync._B	Output, Sync signal, Recall Preset memory 1 (all channels)

Pin3	Sync._C	Output, Sync signal, Recall Preset memory 2 (all channels)
Pin4	Reserved	Reserved
Pin5	Sync._MEM_1	Output, Sync signal, Recall Setup memory 1 (all channels)
Pin6	Sync._MEM_2	Output, Sync signal, Recall Setup memory 2 (all channels)
Pin7	Sync._MEM_3	Output, Sync signal, Recall Setup memory 3 (all channels)
Pin8	Sync._MEM_4	Output, Sync signal, Recall Setup memory 4 (all channels)
Pin9	Sync._Enable	Output, Sync signal, Enable Load (On/Off), recall Preset memory (0-3) and Setup memory (1-4)
Pin10	Sync._Load On/Off	Output, Sync signal, Load On/Off
Pin11	NC	No connection
Pin12	NC	No connection
Pin13	NC	No connection
Pin14	NC	No connection
Pin15	Load Status	Output, load on status
Pin16	Alarm Status	Output alarm activated
Pin17	N.C	No connection

	Pin18	+5V	Power source output, +5V, 100 mA
	Pin19	GND	Ground
	Pin20	GND	Ground
Explanation	<ul style="list-style-type: none"> • Input: active low (0-1 V) active high (4-5 V) • Note: Input type is internally pulled up to 5 V with a 10 kΩ resistor. • Output: high (floating) low (0-1 V) • Note: Output type is internally Open collector outputs, maximum 30 VDC with 1.1 V saturation voltage (100 mA). • When Enable (pin9) is on (active low), the following is disabled from the mainframe: Load On/Off (pin 10) activating loads and recalling preset (pin 1-3) or setup memory (pin 5-8). 		
Frame Link Constraints	<ul style="list-style-type: none"> • You can link up to five devices (one master and four slave units) with a maximum cable length of 30 cm for each cable. • You must turn on all connected devices. • No loop or parallel connections. 		

Configure Go/NoGo Interface

Connection Use a DSUB (DB-15 female) connector to connect to the go/nogo port.

The go/nogo port is an output-only port.

GO / NG OUTPUT

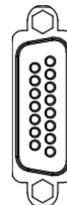

Pin assignment

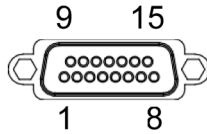

Pin1	Ch1_GO/NG	Pin9	Ch5_GO/NG
Pin2	GND	Pin10	GND
Pin3	Ch2_GO/NG	Pin11	Ch6_GO/NG
Pin4	GND	Pin12	GND
Pin5	Ch3_GO/NG	Pin13	Ch7_GO/NG
Pin6	GND	Pin14	GND
Pin7	Ch4_GO/NG	Pin15	Ch8_GO/NG
Pin8	GO/NG_Enable		

Connection Type	Open collector output maximum 30 VDC with 1.1 V saturation voltage (100 mA).	
	30 V DC (high)	Pass (go) or SPEC test: off
	1.1 V DC (low)	Fail (nogo)

USB Interface Connection

Connection For USB remote connection, use the USB-B port on the mainframe rear panel.



F_{AO}

Q1. The load voltage indicated on the load module is below the expected voltage.

A1. Ensure that the load leads are as short as possible, twisted, and use the appropriate wire gauge. Ensure that you use voltage sense; this can help alleviate the voltage drop across the load leads.

Q2. When I try to start a program sequence, it does not run. “No Active Channel” is displayed.

A2. Ensure that the channel(s) is activated (not set to off) in the FUNC→Program→Active Channel menu.

Q3. When trying to save to USB, the USB memory stick is unresponsive.

A3. Try restarting the RMX-400x mainframe. If this does not solve the problem, ensure that the USB memory is cleanly formatted.

Q4. When I try to clear an alarm, it does not work.

A4. Before clearing an alarm or using the Protection Clear All function, you must turn off the DUT. When the DUT is off, you can clear the alarm(s).

For more information, contact your local dealer or National Instruments at www.ni.com.

APPENDIX

Fuse Replacement

- Step
1. Turn off the power at the wall outlet and rear panel. Remove the power cord.
 2. Remove the fuse socket using a minus driver.

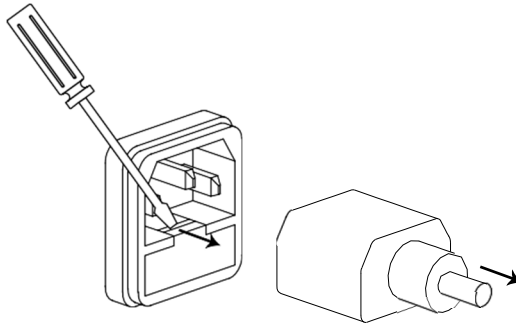

3. Replace the fuse in the holder.

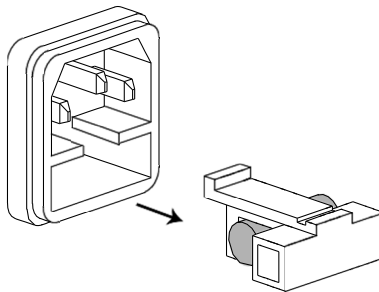

Rating T3.15 A, 250 V

Firmware Update

Background You can update the RMX-400x firmware using a USB memory stick. For the latest firmware, contact your local National Instruments distributor or download the latest firmware from www.ni.com.

Filename File: P2KAXXXX.UPG



Note

Copy the firmware file (*.UPG) to the root directory of a USB stick before proceeding with the firmware update.

Panel Operation 1. Insert a USB flash drive into the front panel USB slot.

2. Press the File key.

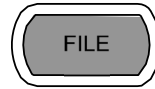

3. Press F1 repeatedly until the Media USB menu appears.

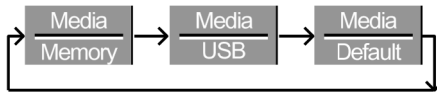

4. Press F5 (File Utility).



5. Use the selector knob to scroll down to the firmware file (*.UPG) and press the selector knob, Enter, or F1.

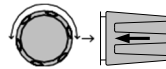

6. Press F1 to confirm the firmware upgrade.



- Wait for the firmware upgrade to finish. A message displays on completion.

- Turn the power off.



Recall Factory
Default

- Turn the power on.

- Press the File key.



- Press F1 repeatedly until the Media Default menu appears.

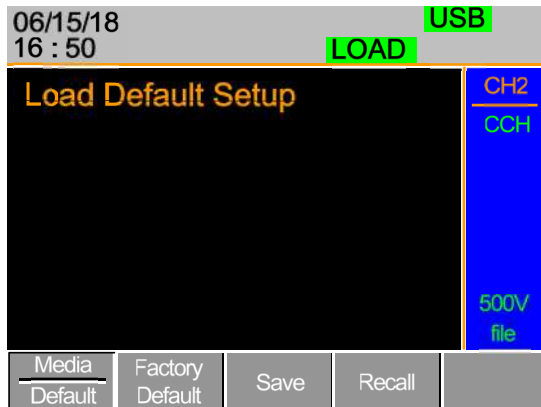

- Press Factory Default (F2) to recall the factory default settings.



- The firmware updating process is complete, and you can use the device now.



14. Press F2 again to ensure recalling the factory default setting.

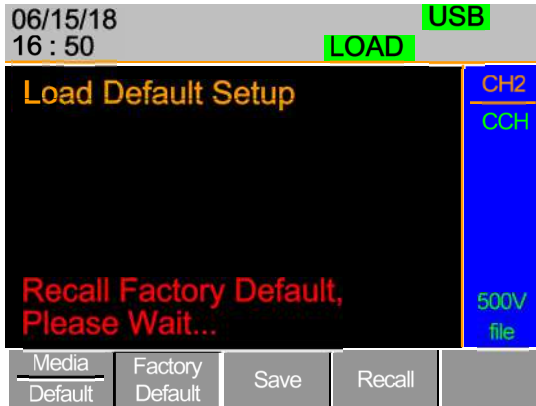

15. Wait a short time for the settings to be recalled.

Calibration

Background Recommended calibration interval for the load modules is 12 months. If you require calibration, contact NI sales or service.

End-user calibration is not supported.

Range Chart

RMX-4003
Low Range
10 W

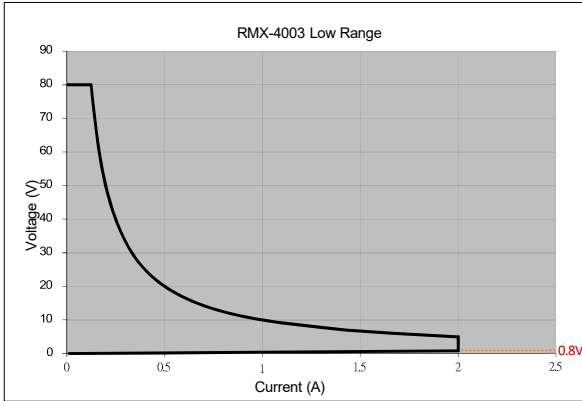

RMX-4003
High Range
100 W

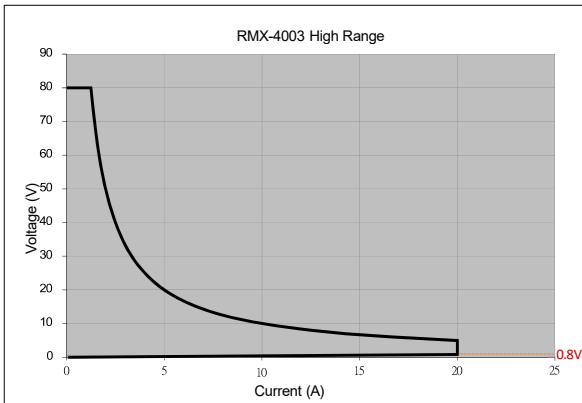

RMX-4003 CV
Low Range

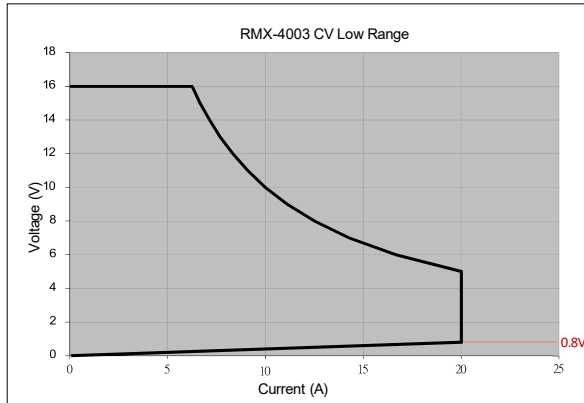

RMX-4004 (L)
High Range
30 W

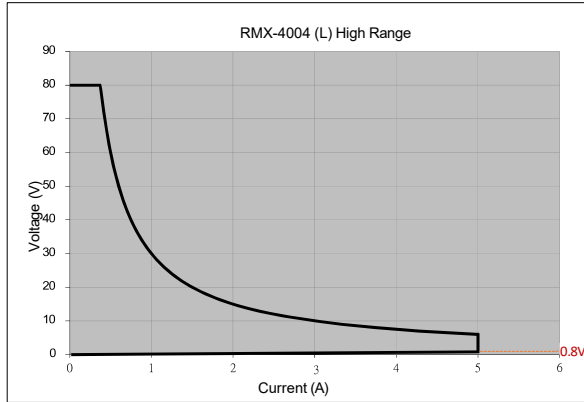

RMX-4004 (L)
CV Low Range

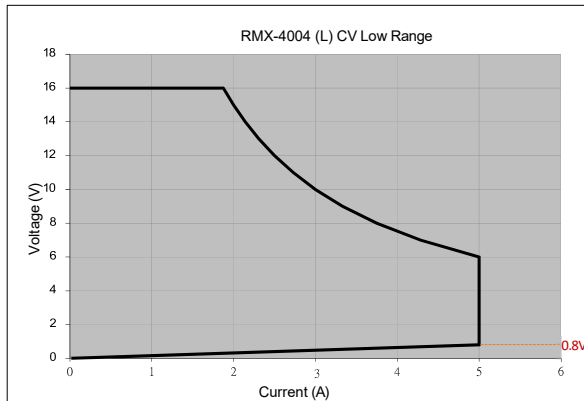

RMX-4004 (R)
Low Range
25 W

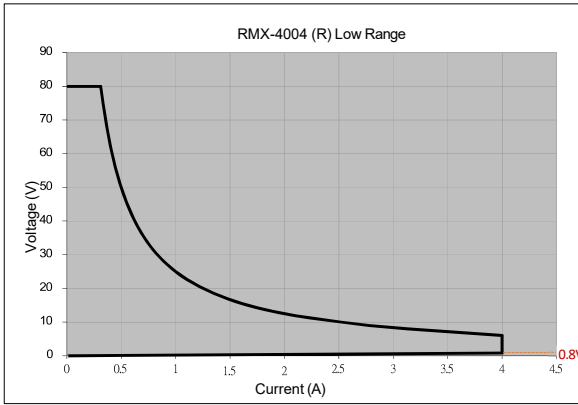

RMX-4004 (R)
High Range
250 W

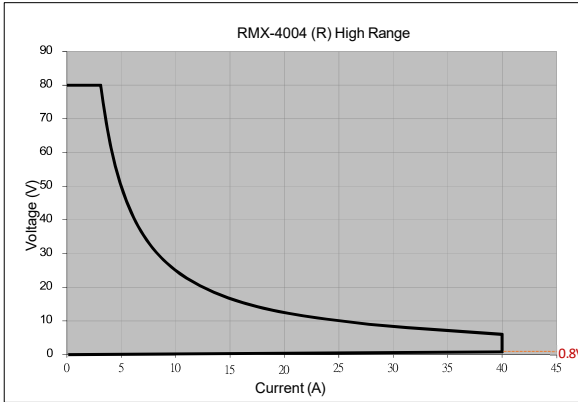

RMX-4004 (R)
CV Low Range

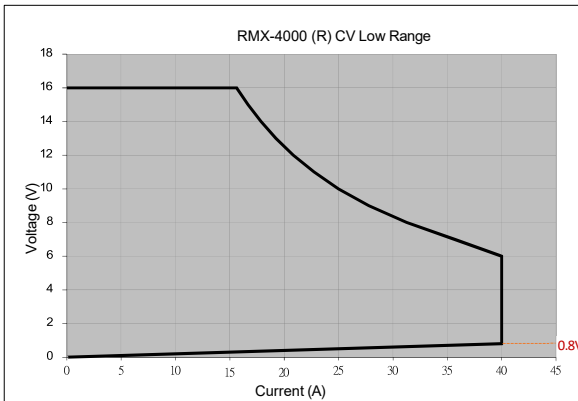

RMX-4005
Low Range
35 W

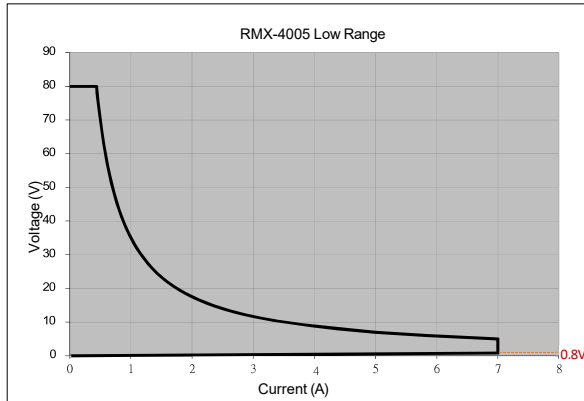

RMX-4005
High Range
350 W

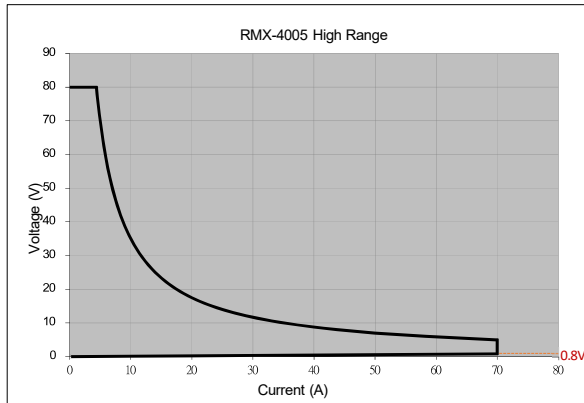

RMX-4005 CV
Low Range

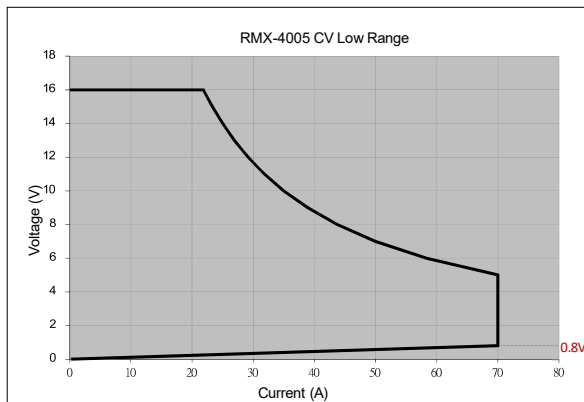

RMX-4006
Low Range
35 W

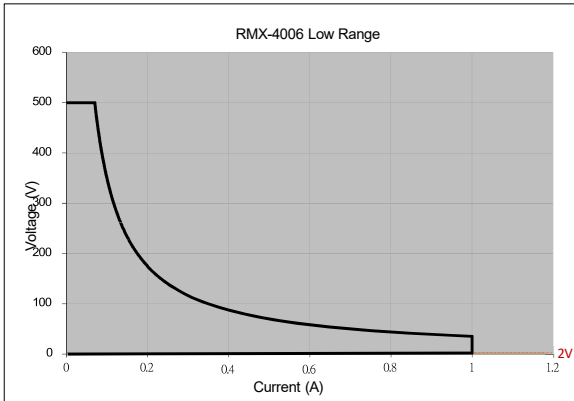

RMX-4006
High Range
350 W

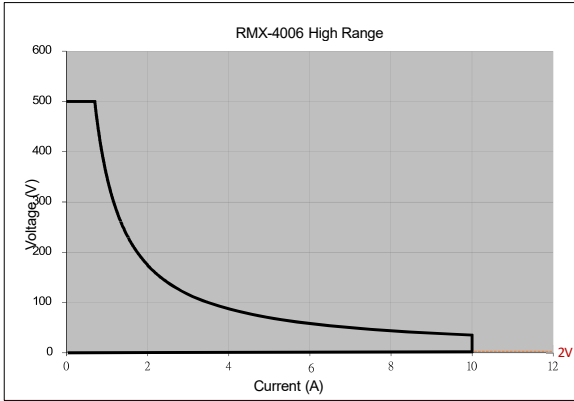

RMX-4006 CV
Low Range

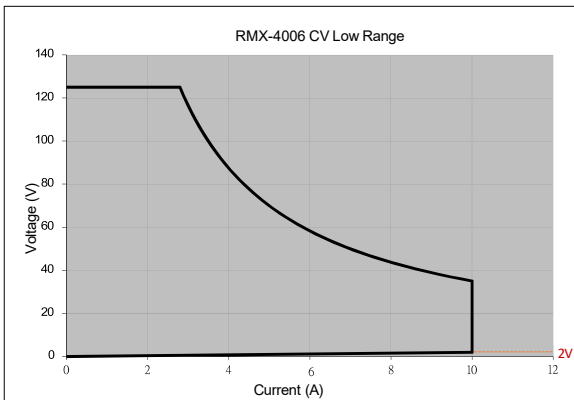

Default Settings

Menu Item		
CC Mode	Range: High A/B Value: Min A Falling Slew Rate: Max	Mode: Static Rising Slew Rate: Max
CR Mode	Range: High A/B Value: Max Ω Falling Slew Rate: Max	Mode: Static Rising Slew Rate: Max
CV Mode	Range: High A/B Value: Max V Curr Limit: Max A	Response: Slow I Meas: High
CP Mode	Range: High Curr Limit: Max A	A/B Value: Min W
CHAN- Protection	OCP Level: Max OVP Level: Max OPP Level: Max UVP Level: OFF Protection Clear: All	OCP Setting: OFF OVP Setting: OFF OPP Setting: OFF UVP Setting: Clear
CHAN- Other	CC Vrange: High Von Latch: OFF Independent: OFF Response: Fast CCL Step: Min CRL Step: Min CVL Step: Min CPL Step: Min Short Key: Toggle	Von Voltage: 0 V CH CONT: Pane Load D-Time: 0.0 s CCH Step: Min CRH Step: Min CVH Step: Min CPH Step: Min Short Function: ON Short Safety: ON

CHAN-Group	Total Units: OFF Display Mode: V, I	Group Mode: Para
CHAN- Seq. Edit	NO.: 001 Rising/Falling SlewRate: Max	Value: Min Duration Time: 0.000025 s
CHAN- Seq. Edit - Loop	Repeat: Infinity Times On End Of Seq.: OFF A (CC mode) OFF Ω /OFF K Ω (CR mode)	Start of Loop: 001 Point CC Vrange: High
CHAN- Go/NoGo	SPEC Test: OFF Entry Mode: Value Low: Min	Delay Time: 0.0 s High: Max
FUNC- Program	PROG: 01 Memory: M001 On-Time: 0.1 s P/F-Time: Off Short Channel: All channels	SEQ: 01 Run: Skip Off-Time: Off Short-Time: Off
FUNC- Program Chain	Start: P01	P01-P12→: Off
FUNC- Program- Active Channel	CH 01-08: Active: OFF	Prog: Off
FUNC- Sequence	Seq.: Off TRIG: CH1: OUT Setting: CH01-CH08: OFF	TRIG In: Off TRIG: CH2-08: IN
FUNC- OCP	OCP: Off Range: High End C: Setting Range Max Last_C: Min	Chan: 1 Start C: Min Step_C: Min Step_T: Min

	Delay: Min	Trig_V: Min
	Keep_T: Min	
FUNC- OCP- Active Channel	CH 01-08: Active: Off	
FILE- Memory	Channel Data: Current Memory: M001	Data Type: Memory
FILE- USB	Channel Data: Current Save File: No File	Data Type: Memory Recall File: No File
UTILITY- Load	Auto Load: OFF	Auto Load On: Prog
UTILITY - Interface	USB	
UTILITY - Other	Speaker: OFF Brightness: 70 Alarm (M): ON Knob Type: Updated Slave Knob: SetValue High Resoulution: ON Von Latch Clear: Auto Jog Shuttle Control: OFF	Contrast: 8 Frame CONT: OFF Alarm (S): OFF Go_NoGo Tone: OFF Language: English System Mode: 0 Measure Period: 200 ms RVP Load Off: OFF

Specifications

The specifications apply when the RMX-400x series is powered on for at least 30 minutes to warm up to a temperature of $25^{\circ}\text{C} \pm 5^{\circ}\text{C}$, unless specified otherwise.

	RMX-4000	RMX-4002
MODULE SLOTS	2	4
General		
Operating Environment		
Temperature	0 °C to 40 °C	
Altitude	Up to 2000 m	
Location	Indoor, no direct sunlight, dust free, almost nonconductive pollution.	
Storage Environment		
Temperature	-10 °C to 70 °C	
Relative humidity	< 90% RH	
Location	Indoor	
Power supply	AC input voltage range: 100-120 Vac / 200-240 Vac (90-132 Vac / 180-250 Vac)	
	Frequency: 47-63 Hz	
	Power rating: RMX-4002: 250 VA Max RMX-4000: 150 VA Max	
	Transient overvoltage on the main supply is 2500 V.	
Fuse	T3.15 A/250 V	
Pollution degree	2	
Measurement category	1	
Rear panel USB class	USB 2.0 full speed (CDC-ACM)	
Weight	Approx. 17.1 kg (full modules)	Approx 28.4 kg (full modules)

RMX-4003 (100 W x 2)		
Range	Low	High
Current	0-2 A	0-20 A
Voltage	0-80 V	
Min. operating voltage (dc) typ.	0.4 V at 2 A 0.2 V at 1 A	0.8 V at 20 A 0.4 V at 10 A

Static Mode

Constant Current Mode

Operating range	0-2 A	0-20 A
Setting Range	0-2.04 A	0-20.4 A
Resolution	0.1 mA	1 mA
Accuracy	$\pm(0.1\% \text{ set} + 0.1\% \text{ F.S.}^{*1})$	$\pm(0.1\% \text{ set} + 0.2\% \text{ F.S.})$

Constant Resistance Mode

Operating Range	0.075 Ω -300 Ω (100 W/16 V) 3.75 Ω -15 k Ω (100 W/80 V)
Setting Range	0.075 Ω -300 Ω (100 W/16 V) 3.75 Ω -15 k Ω (100 W/80 V)
Resolution	0.333 mS(100 W/16 V) 6.667 μ S(100 W/80 V)
Accuracy	300 Ω : $\pm(0.2\% \text{ set} + 0.1 \text{ s})$ 15 k Ω : $\pm(0.1\% \text{ set} + 0.01 \text{ s})$

Constant Voltage + Constant Current Mode

Operating range	1-16 V	1-80 V
Setting range	0-16.32 V	0-81.6 V
Resolution	0.4 mV	2 mV
Accuracy	$\pm(0.05\% \text{ set} + 0.1\% \text{ F.S.})$	
Current setting range	0-2.04 A	0-20.4 A
Resolution	0.1 mA	1 mA
Accuracy	$\pm(0.1\% \text{ set} + 0.1\% \text{ F.S.}^{*1})$	$\pm(0.1\% \text{ set} + 0.2\% \text{ F.S.}^{*1})$

*1: F.S. = Full scale of H range

Constant Power + Constant Current Mode

Operating range	1-10 W	1-100 W
Setting range	0-10.2 W	0-102 W
Resolution	1 mW	10 mW
Accuracy	$\pm(0.5\% \text{ set} + 0.5\% \text{ F.S.}^{*1})$	$\pm(0.5\% \text{ set} + 0.5\% \text{ F.S.})$

Current Setting Range	0-2.04 A	0-20.4 A
Resolution	0.1 mA	1 mA
Accuracy	$\pm(0.1\% \text{ set} + 0.1\% \text{ F.S.}^{*1})$	$\pm(0.1\% \text{ set} + 0.2\% \text{ F.S.}^{*1})$

*1: F.S. = Full scale of H range

Dynamic Mode

T ₁ and T ₂	0.025 ms – 10 ms / Res: 1 μ s 10 ms – 30 s / Res: 1 ms
Accuracy	1 μ s/1 ms \pm 100 ppm

Constant Current Mode

Slew rate	0.32-80 mA/ μ s	3.2-800 mA/ μ s
Slew rate resolution	0.32 mA/ μ s	3.2 mA/ μ s
Slew rate setting accuracy	$\pm(10\% + 15 \mu\text{s})$	$\pm(10\% + 15 \mu\text{s})$
Current setting range	0-2.04 A	0-20.4 A
Current resolution	0.1 mA	1 mA
Current accuracy	$\pm 0.4\%$ F.S.	

Constant Resistance Mode

Slew rate	3.2-800 mA/ μ s
Slew rate resolution	3.2 mA/ μ s
Slew rate setting accuracy	$\pm(10\% + 50 \mu\text{s})$
Resistance setting range	0.075 Ω -300 Ω (100 W/16 V) 3.75 Ω -15 k Ω (100 W/80 V)
Resistance resolution	0.333 mS(100 W/16 V) 6.667 μ S(100 W/80 V)
Resistance accuracy	300 Ω : $\pm(0.5\%$ set + 0.1 s) 15 k Ω : $\pm(0.5\%$ set + 0.01 s)

Measurement
Voltage Readback

Range	0-16 V	0-80 V
Resolution	0.32 mV	1.6 mV
Accuracy	$\pm(0.025\%$ set + 0.025% F.S.)	

Current Readback

Range	0-2 A	0-20 A
Resolution	0.04 mA	0.4 mA

Accuracy $\pm(0.05\% \text{ set} + 0.05\% \text{ F.S.}^{*2})$

Power Readback

Range 0-10 W 0-100 W

Accuracy $\pm(0.1\% \text{ set} + 0.1\% \text{ F.S.}^{*1})$

*1 : Power F.S. = Vrange F.S. x Irange F.S.

*2 : F.S. = Full scale of H range

Protective

Over Power Protection

Range 1-102 W

Resolution 0.5 W

Accuracy $\pm(2\% \text{ set} + 0.25\% \text{ F.S.})$

Over Current Protection

Range 0-25-20.4 A

Resolution 0.05 A

Accuracy $\pm(2\% \text{ set} + 0.25\% \text{ F.S.})$

Over Voltage Protection

Range 1-81.6 V

Resolution 0.2 V

Accuracy $\pm(2\% \text{ set} + 0.25\% \text{ F.S.})$

Over temperature protection 85 °C

Rated Power Protection (CPP)

Value 110 W

Accuracy $\pm 5\% \text{ set}$

General

Short Circuit

Current (CC) 2.2/2 A $\approx 22/20 \text{ A}$

Voltage (CV) = 0 V

Resistance (CR) 3.75 Ω $\approx 0.075 \Omega$

Input resistance (load off) 500 k Ω (typical)

Temperature coefficient 100 ppm

Weight Approx. 3.8 kg

RMX-4004 (30 W/250 W)			
Range	High	Low	High
Current	0-5 A	0-4 A	0-40 A
Voltage	0-80 V		
Min Operating Voltage (dc)	0.8 V at 5 A 0.4 V at 2.5 A	0.4 V at 4 A 0.2 V at 2 A	0.8 V at 40 A 0.4 V at 20 A

STATIC MODE
Constant Current Mode

Operating range	0-5 A	0-4 A	0-40 A
Setting range	0-5.1 A	0-4.08 A	0-40.8 A
Resolution	0.125 mA	0.1 mA	1 mA
Accuracy	$\pm(0.1\% \text{ set} + 0.1\% \text{ F.S.})$	$\pm(0.1\% \text{ set} + 0.1\% \text{ F.S.})^{*1}$	$\pm(0.1\% \text{ set} + 0.2\% \text{ F.S.})$

Constant Resistance Mode

Operating range	0.3 Ω -1.2 k Ω (30 W/16 V) 15 Ω -60 k Ω (30 W/80 V)	0.0375 Ω -150 Ω (250 W/16 V) 1.875 Ω -7.5 k Ω (250 W/80 V)
Setting range	0.3 Ω -1.2 k Ω (30 W/16 V) 15 Ω -60 k Ω (30 W/80 V)	0.0375 Ω -150 Ω (250 W/16 V) 1.875 Ω -7.5 k Ω (250 W/80 V)
Resolution	83.333 μ s (30 W/16 V) 1.666 μ s (30 W/80 V)	0.666 mS(250 W/16 V) 13.333 μ S(250 W/80 V)
Accuracy	1.2 k Ω : \pm (0.2% set + 0.1 s) 60 k Ω : \pm (0.1% set + 0.01 s)	150 Ω : $\pm(0.2\% \text{ set} + 0.1 \text{ s})$ 7.5k Ω : $\pm(0.1\% \text{ set} + 0.01 \text{ s})$

Constant Voltage + Constant Current Mode

Operating range	1-16 V	1-80 V	1-16 V	1-80 V
Setting range	0-16.32 V	0-81.6 V	0-16.32 V	0-81.6 V
Resolution	0.4 mV	2 mV	0.4 mV	2 mV
Accuracy	$\pm(0.05\% \text{ set} + 0.1\% \text{ F.S.})$	$\pm(0.05\% \text{ set} + 0.1\% \text{ F.S.})$		

Current setting range	0-5.1 A	0-4.08 A	0-40.8 A
Resolution	0.125 mA	0.1 mA	1 mA
Accuracy	$\pm(0.1\% \text{ set} + 0.2\% \text{ F.S.})$	$\pm(0.1\% \text{ set} + 0.1\% \text{ F.S.}^{*1})$	$\pm(0.1\% \text{ set} + 0.2\% \text{ F.S.}^{*1})$

*1: F.S. = Full scale of H range

Constant Power + Constant Current Mode

Operating range	1-30 W	1-25 W	1-250 W
Setting range	0-30.6 W	0-25.5 W	0-255 W
Resolution	1 mV	1 mV	10 mV
Accuracy	$\pm(0.5\% \text{ set} + 0.5\% \text{ F.S.})$	$\pm(0.5\% \text{ set} + 0.5\% \text{ F.S.}^{*1})$	
Current setting range	0-5.1 A	0-4.08 A	0-40.8 A
Resolution	0.125 mA	0.1 mA	1 mA
Accuracy	$\pm(0.1\% \text{ set} + 0.2\% \text{ F.S.})$	$\pm(0.1\% \text{ set} + 0.1\% \text{ F.S.}^{*1})$	$\pm(0.1\% \text{ set} + 0.2\% \text{ F.S.}^{*1})$

*1: F.S. = Full scale of H range

Dynamic Mode

T ₁ and T ₂	0.025 ms – 10 ms / Res: 1 μ s 10 ms – 30 s / Res: 1 ms
Accuracy	1 μ s / 1 ms + 100 ppm

Constant Current Mode

Slew rate	0.8 – 200 mA/ μ s	0.64–160 mA/ μ s	6.4–1600 mA/ μ s
Slew rate resolution	0.8 mA/ μ s	0.64 mA/ μ s	6.4 mA/ μ s
Slew rate setting accuracy	$\pm(10\% + 15 \text{ } \mu\text{s})$	$\pm(10\% + 15 \text{ } \mu\text{s})$	$\pm(10\% + 15 \text{ } \mu\text{s})$
Current setting range	0-5.1 A	0-4.08 A	0-40.8 A
Current resolution	0.125 mA	0.1 mA	1 mA
Current accuracy	$\pm 0.4\% \text{ F.S.}$		

Constant Resistance Mode

Slew rate	0.8-200 mA/ μ s	6.4-1600 mA/ μ s
Slew rate resolution	0.8 mA/ μ s	6.4 mA/ μ s
Slew rate setting accuracy	$\pm(10\% + 50 \text{ } \mu\text{s})$	

Resistance setting range	0.3 Ω-1.2 kΩ (30 W/16 V) 15 Ω-60 kΩ (30 W/80 V)	0.0375 Ω-150 Ω (250 W/16 V) 1.875 Ω-7.5 kΩ (250 W/80 V)
Resistance Resolution	83.333 μS (30 W/16 V) 1.666 μS (30 W/80 V)	0.666 mS (250 W/16 V) 13.333 μS(250 W/80 V)
Resistance Accuracy	1.2 kΩ: ±(0.5% set + 0.1 s) 60 kΩ: ±(0.5% set + 0.01 s)	150 Ω: ±(0.5% set + 0.1 s) 7.5 kΩ: ±(0.5% set + 0.01 s)

Measurement

Voltage Readback

Range	0-16 V	0-80 V	0-16 V	0-80 V
Resolution	0.32 mV	1.6 mV	0.32 mV	1.6 mV
Accuracy	±(0.025% set + 0.025% F.S.)			

Current Readback

Range	0-5 A	0-4 A	0-40 A
Resolution	0.1 mA	0.08 mA	0.8 mA
Accuracy	±(0.05% set + 0.05% F.S. *2)		

Power Readback

Range	0-30 W	0-25 W	0-250 W
Accuracy	±(0.1% set + 0.1% F.S. *1)	±(0.1% set + 0.1% F.S. *1)	

*1: Power F.S. = Vrange F.S. x Irange F.S.

*2: F.S. = Full scale of H range

PROTECTIVE

Over Power Protection

Range	0.9-30.6 W	1.25-255 W
Resolution	0.15 W	1.25 W
Accuracy	±(2% set + 0.25% F.S.)	±(2% set + 0.25% F.S.)

Over Current Protection

Range	0.0625-5.1 A	0.5-40.8 A
-------	--------------	------------

Resolution	0.0125 A	0.1 A
Accuracy	$\pm(2\% \text{ set} + 0.25\% \text{ F.S.})$	$\pm(2\% \text{ set} + 0.25\% \text{ F.S.})$
Over Voltage Protection		
Range	1-81.6 V	1-81.6 V
Resolution	0.2 V	0.2 V
Accuracy	$\pm(2\% \text{ set} + 0.25\% \text{ F.S.})$	$\pm(2\% \text{ set} + 0.25\% \text{ F.S.})$
Over Temperature Protection	85 °C	
Rated Power Protection (CPP)		
Value	33 W	275 W
Accuracy	$\pm 5\% \text{ set}$	

General

Short Circuit				
Current (CC)	5.5/5 A	4.4/4 A	44/40 A	
Voltage (CV)	0 V	= 0 V	0 V	
Resistance (CR)	15 Ω	0.3 Ω	1.875 Ω	0.0375 Ω
Input resistance (load off)	500 k Ω (Typical)			
Temperature Coefficient	100 ppm			
Weight	Approx. 3.8 kg			

	RMX-4005		RMX-4006	
Range	Low	High	Low	High
Current	0-7 A	0-70 A	0-1 A	0-10 A
Voltage	0-80 V		0-500 V	
Min operating voltage (dc) typ.	0.4 V at 7 A	0.8 V at 70 A	1 V at 1 A	2 V at 10 A
	0.2 V at 3.5 A	0.4 V at 35 A	0.5 V at 0.5 A	1 V at 5 A

Static Mode

Constant Current Mode

Operating range	0-7 A	0-70 A	0-1 A	0-10 A
Setting range	0-7.14 A	0-71.4 A	0-1.02 A	0-10.2 A
Resolution	0.2 mA	2 mA	0.05 mA	0.5 mA
Accuracy	$\pm(0.1\% \text{ set} + 0.1\% \text{ F.S.}^{*1})$	$\pm(0.1\% \text{ set} + 0.2\% \text{ F.S.})$	$\pm(0.1\% \text{ set} + 0.1\% \text{ F.S.}^{*1})$	$\pm(0.1\% \text{ set} + 0.2\% \text{ F.S.})$

Constant Resistance Mode

Operating range	0.025 Ω -100 Ω (350 W/16V) 1.25 Ω -5 k Ω (350 W/80 V)	1.25 Ω -5 k Ω (350 W/125 V) 50 Ω -200 k Ω (350 W/500 V)
Setting range	0.025 Ω -100 Ω (350 W/16 V) 1.25 Ω -5 k Ω (350 W/80 V)	1.25 Ω -5 k Ω (350 W/125 V) 50 Ω -200 k Ω (350 W/500 V)
Resolution	1 ms (350 W/16 V) 20 μ s (350 W/80 V)	20 μ s (350 W/125 V) 0.5 μ s (350 W/500 V)
Accuracy	100 Ω : $\pm(0.2\% \text{ set} + 0.1 \text{ s})$ 5 k Ω : $\pm(0.1\% \text{ set} + 0.01 \text{ s})$	5 k Ω : $\pm(0.2\% \text{ set} + 0.02 \text{ s})$ 200 k Ω : $\pm(0.1\% \text{ set} + 0.005 \text{ s})$

Constant Voltage + Constant Current Mode

Operating range	1-16 V	1-80 V	2.5-125 V	2.5-500 V
Setting range	0-16.32 V	0-81.6 V	0-127.5 V	0-510 V
Resolution	0.4 mV	2 mV	2.5 mV	10 mV
Accuracy	$\pm(0.05\% \text{ set} + 0.1\% \text{ F.S.})$		$\pm(0.05\% \text{ set} + 0.1\% \text{ F.S.})$	
Current setting range	0-7.14 A	0-71.4 A	0-1.02 A	0-10.2 A
Resolution	0.2 mA	2 mA	0.05 mA	0.5 mA

Accuracy	$\pm(0.1\% \text{ set} + 0.1\% \text{ F.S.}^{*1})$	$\pm(0.1\% \text{ set} + 0.2\% \text{ F.S.}^{*1})$	$\pm(0.1\% \text{ set} + 0.1\% \text{ F.S.}^{*1})$	$\pm(0.1\% \text{ set} + 0.2\% \text{ F.S.}^{*1})$
----------	--	--	--	--

Constant Power + Constant Current Mode

Operating range	1-35 W	1-350 W	1-35 W	1-350 W
-----------------	--------	---------	--------	---------

Setting range	0-35.7 W	0-357 W	0-35.7 W	0-357 W
---------------	----------	---------	----------	---------

Resolution	1 mW	10 mW	1 mW	10 mW
------------	------	-------	------	-------

Accuracy	$\pm(0.5\% \text{ set} + 0.5\% \text{ F.S.}^{*1})$	$\pm(0.5\% \text{ set} + 0.5\% \text{ F.S.})$	$\pm(0.5\% \text{ set} + 0.2\% \text{ F.S.}^{*1})$	$\pm(0.5\% \text{ set} + 0.5\% \text{ F.S.})$
----------	--	---	--	---

Current Setting Range	0-7.14 A	0-71.4 A	0-1.02 A	0-10.2 A
-----------------------	----------	----------	----------	----------

Resolution	0.2 mA	2 mA	0.05 mA	0.5 mA
------------	--------	------	---------	--------

Accuracy	$\pm(0.1\% \text{ set} + 0.1\% \text{ F.S.}^{*1})$	$\pm(0.1\% \text{ set} + 0.2\% \text{ F.S.}^{*1})$	$\pm(0.1\% \text{ set} + 0.1\% \text{ F.S.}^{*1})$	$\pm(0.1\% \text{ set} + 0.2\% \text{ F.S.}^{*1})$
----------	--	--	--	--

*1: F.S. = Full scale of H range

Dynamic Mode

T ₁ and T ₂	0.025 ms-10 ms/Res: 1 μ s 10 ms – 30 s / Res: 1 ms
-----------------------------------	---

Accuracy	1 μ s / 1 ms \pm 100 ppm
----------	--------------------------------

Constant Current Mode

Slew rate	0.001-0.28 A/ μ s	0.01-2.8 A/ μ s	0.16-40 mA/ μ s	1.6-400 mA/ μ s
-----------	-----------------------	---------------------	---------------------	---------------------

Slew rate resolution	0.001 A/ μ s	0.01A/ μ s	0.16mA/ μ s	1.6mA/ μ s
----------------------	------------------	----------------	-----------------	----------------

Slew rate setting accuracy	$\pm(10\% + 15 \text{ } \mu\text{s})$			
----------------------------	---------------------------------------	--	--	--

Current setting range	0-7.14 A	0-71.4 A	0-1.02 A	0-10.2 A
-----------------------	----------	----------	----------	----------

Current resolution	0.2 mA	2 mA	0.05 mA	0.5 mA
--------------------	--------	------	---------	--------

Current accuracy	$\pm 0.4\% \text{ F.S.}$		$\pm 0.4\% \text{ F.S.}$	
------------------	--------------------------	--	--------------------------	--

Constant Resistance Mode

Slew rate	0.01-2.8 A/ μ s	1.6-400 mA/ μ s
-----------	---------------------	---------------------

Slew rate resolution	0.01 A/ μ s	1.6 mA/ μ s
----------------------	-----------------	-----------------

Slew rate setting accuracy	$\pm(10\% + 50 \text{ } \mu\text{s})$	
----------------------------	---------------------------------------	--

Resistance setting range	0.025 Ω -100 Ω (350 W/16 V)	1.25 Ω -5 k Ω (350 W/125 V)
--------------------------	--	--

1.25 Ω -5 k Ω (350 W/80 V) 50 Ω -200 k Ω (350W/500 V)

Resistance resolution	1 ms (350 W/16 V)	20 μ s (350 W/125 V)
	20 μ s (350 W/80 V)	0.5 μ s (350 W/500 V)
Resistance accuracy	100 Ω : $\pm(0.5\%$ set + 0.1 s)	5 K Ω : $\pm(0.5\%$ set + 0.02 s)
	5 k Ω : $\pm(0.5\%$ set + 0.01 s)	200 k Ω : $\pm(0.5\%$ set + 0.005 s)

Measurement

Voltage Readback

Range	0-16 V	0-80 V	0-125 V	0-500 V
Resolution	0.32 mV	1.6 mV	2.5 mV	10 mV
Accuracy	$\pm(0.025\%$ set + 0.025% F.S.)			

Current Readback

Range	0-7 A	0-70 A	0-1 A	0-10 A
Resolution	0.14 mA	1.4 mA	0.02 mA	0.2 mA
Accuracy	$\pm(0.05\%$ set + 0.05% F.S. *2)			

Power Readback

Range	0-35 W	0-350 W	0-35 W	0-350 W
Accuracy	$\pm(0.1\%$ set + 0.1% F.S. *1)			

*1 : Power F.S. = Vrange F.S. x Irange F.S.

*2 : F.S. = Full scale of H range

Protective

Over Power Protection

Range	1.75-357 W
Resolution	1.75 W
Accuracy	$\pm(2\%$ set + 0.25% F.S.)

Over Current Protection

Range	0.875-71.4 A	0.125-10.2 A
Resolution	0.175 A	0.025 A
Accuracy	$\pm(2\%$ set + 0.25% F.S.)	

Over Voltage Protection

Range	1-81.6 V	2.5-510 V
Resolution	0.2 V	1.25 V
Accuracy	$\pm(2\%$ set + 0.25% F.S.)	

Over temperature protection =85 $^{\circ}$ C

Rated Power Protection (CPP)

Value	385 W
Accuracy	$\pm 5\%$ set

General

Short Circuit

Current (CC)	= 7.7/7 A	= 77/70 A	= 1.1/1 A	= 11/10 A
--------------	-----------	-----------	-----------	-----------

Voltage (CV)	= 0 V			
--------------	-------	--	--	--

Resistance (CR)	1.25 Ω	0.025 Ω	50 Ω	1.25 Ω
-----------------	---------------	----------------	-------------	---------------

Input resistance (load off)	500 k Ω (typical)
--------------------------------	--------------------------

Temperature coefficient	100 ppm
----------------------------	---------

Weight	Approx. 3.8 kg
--------	----------------

Dimensions

RMX-4000/RMX-4002

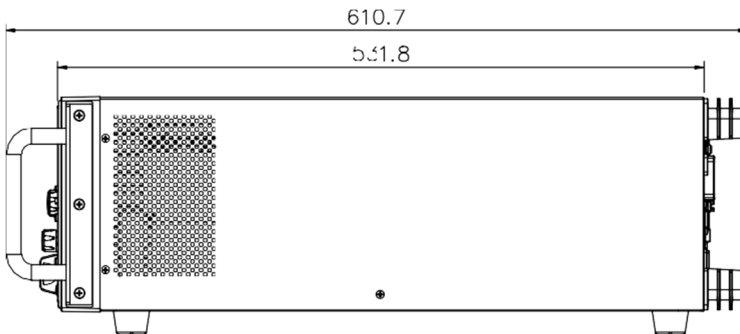
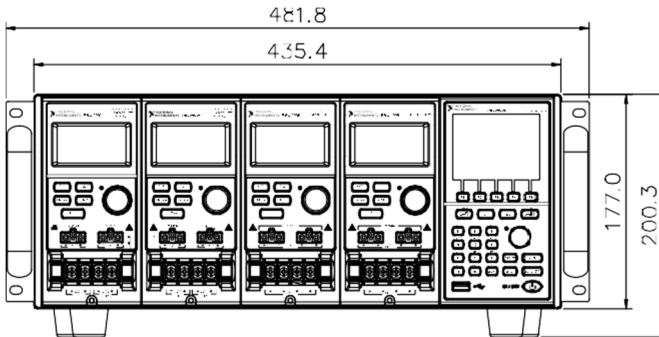
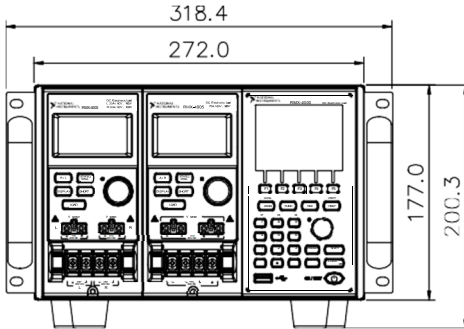

RMX-4003/RMX-4004/RMX-4005/RMX-4006

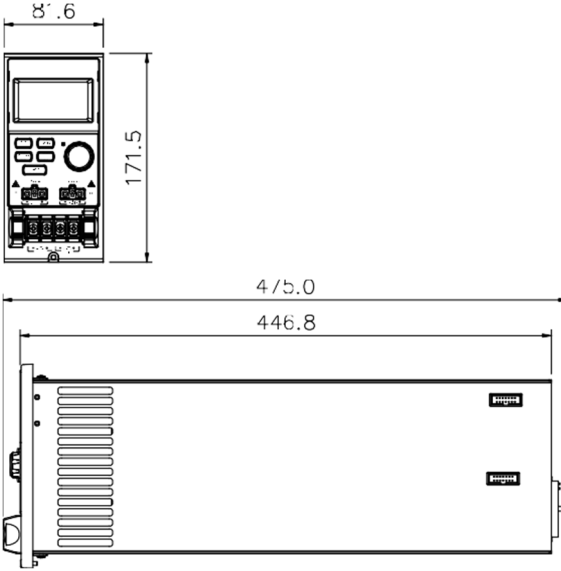

EC Declaration of Conformity

We declare that the below mentioned product

Type of Product: Programmable Electronic Load

Model number: RMX-4000, RMX-4002.

Load module: RMX-4003, RMX-4004, RMX-4005, RMX-4006.

are herewith confirmed to comply with the requirements set out in the Council Directive on the Approximation of the Law of Member States relating to Electromagnetic Compatibility (2014/30/EU) and Low Voltage Directive (2014/35/EU).

For the evaluation regarding the Electromagnetic Compatibility and Low Voltage Directive, the following standards were applied:

© EMC	
EN 61326-1: EN 61326-2-1:	Electrical equipment for measurement, control and laboratory use -- EMC requirements (2013)
Conducted & Radiated Emission EN 55011: 2009 +A1: 2010	Electrostatic Discharge EN 61000-4-2: 2009
Current Harmonics EN 61000-3-2: 2014	Radiated Immunity EN 61000-4-3:2006 +A1:2008+A2:2010
Voltage Fluctuations EN 61000-3-3: 2013	Electrical Fast Transients EN61000-4-4: 2012
-----	Surge Immunity EN 61000-4-5: 2006
-----	Conducted Susceptibility EN 61000-4-6: 2014
-----	Power Frequency Magnetic Field EN 61000-4-8: 2010
-----	Voltage Dip/ Interruption EN 61000-4-11: 2008
Low Voltage Equipment Directive 2014/35/EU	
Safety Requirements	EN 61010-1: 2010 EN 61010-2-030: 2010

INDEX

Alarm configuration	234, 247
All Chan save/recall	
description	108
Baud rate configuration	251, 257
Brightness & contrast.....	242
Brightness and contrast	229
Calibration	325
Calibration key	23
CC vrange mode description	94
CC+CV mode.....	76
Channel configuration	
CC voltage range.....	201
Go/NoGo mode.....	219
Go/NoGo On/Off	221
Independent setting.....	210
Load delay time.....	211
Parallel mode.....	222
Protection All Clear	200
Response time.....	217
SPEC test ON/OFF.....	221
Step resolution.....	213
Channel configuration	
Configuration menu	196
OCP/OCV/OPP	197
Channel configuration	
Von voltage configuration .	203
Channel configuration	
Short	205
Channel configuration	
channel control.....	208
Channel control configuration	208, 313
Channel control connection ..	63
Channel control description	100
Channel control mode	
description	96
Channel duration time	
settings mode description .	88
Cleaning the instrument.....	9
Clear key	23
Configuration mode	
description	92
Connection	
Channel control	63
Frame link	61
Go/NoGo control.....	67
Remote sense	54
Wire gauge.....	50
Wire Inductance	50
Connection procedure	52
Constant power mode	
description	78
Constant Resistance mode	
description	72
Constant voltage + constant	
current mode description ..	76
Constant voltage mode	
description	75
Declaration of conformity	349
Default Settings	331
Delay time mode description	97
Dimensions	347
Display key	36
Display settings	229, 242
Dynamic constant current	
mode description.....	70
Dynamic loads Constant	
Resistance mode description	73



EC Declaration of Conformity	349	Interface menu	251
EN61010		RS232.....	251, 257
measurement category	8	USB configuration.....	253
Pollution degree	9	Internal memory save	
Enter key	25	description.....	107
Environment		Knob configuration.....	233, 246
operation	9	Language Settings.....	239
Storage.....	9	List of features	14
Ethernet		Load (module)key.....	36
sockets	257	Load connections	49
External memory save		Load Connections	
description.....	107	Auxiliary voltage connection	56
External voltage mode		DC Connection.....	56
description.....	100	Dual channel load module ...	55
Features.....	14	Low voltage connections	56
File format mode description	110	Multiple output power source	60
Firmware update	322	Parallel load modules	58
Frame control congifuration	231, 242, 245, 248	Parallel loads.....	58
Frame Link configuration	315	Parallel mainframes.....	59
Frame link connection.....	61	Precautions	49
Front panel overview.	21	Single channel load module .	55
Function Keys.....	21	Single load.....	55
Fuse		Load delay time configuration	211
rating.....	8	Load D-Time mode	
Fuse replacement	321	description.....	97
Go/NoGo Alarm Sound	235	Load key.....	25
Go/NoGo connection.....	67	Load Menu.....	227
Go/NoGo constant current		Load module installation	42
mode description.....	71	Load module Overview	35
Go/NoGo constant Resistance		Load profiling description.....	85
mode description.....	74	Load terminals	37
Go/NoGo constant voltage		Load wire induction	50
mode description.....	77	Load wiring	51
Go/NoGo interface		Local operation	
configuration	319	AandB Value.....	130
Independent configuration ..	210	Channel selection.....	130
Independent mode description	96	coarse mode.....	135
Installation		Display	134
Load module.....	42	Dynamic	131
Rack mount.....	45	Editing the load.....	135
Interface configuration	312	fine mode.....	135
Baud Rate	251, 257	Load	132

Operation	130	Program chain.	171
R/L keys.....	130	Program Execution.....	173
Shorting.....	133	Program Sequences	165
Static	131	Programming.....	165
Lock key	23	Recall default chain.....	173
Mainframe configuration		Recall default sequence	170
alarm sound.....	234, 247	Run Sequence	186
Brightness & contrast	242	Save chain	173
Brightness and contrast.....	229	Save Program chain	173
Configuration menu	225	Save sequence.....	169
Frame control.....	231, 242, 245, 248	Sequence loop.....	182
Go/NoGo Tone	235	Trig out.....	184
Knob type.....	233, 246	Measurement types.....	18, 20
Language.....	239	Memory data description.....	105
Load menu.....	227	Number pad.....	23
Slave knob.....	237, 248	OCP test automation.....	189
Speaker	228, 240	OCP Test Automation	
System Info	225	description	90
Utility menu.....	225	Operating configurations	
Mainframe operation		mode description	94
CC Dynamic mode.....	141	Operating Description	68
CC Mode	139	Operating Modes	
CC Range	140	Channel duration time	
CC Static mode.....	143	settings	88
CC Static Values.....	144	Configuration.....	92
Channel duration time		Configuration - Over current	
settings	184	protection.....	93
Channel Selection.....	136, 137	Configuration - Over power	
CP Current limit.....	161	protection	94
CP mode.....	160	Configuration - Over voltage	
CP Power values	161	protection.....	93
CP range.....	158, 164	Constant current - Go/NoGo	71
CR Range.....	147	Constant current - Slew rate	71
CR Static Parameters	152	Constant current -Dynamic	70
CR Dynamic mode.....	149	Constant current -static	70
CR mode.....	146	Constant Power	78
CR Static mode.....	151	Constant Resistance	72
CV Current limit	155	Constant Resistance -	
CV mode.....	154	Dynamic loading	73
CV response speed	159	Constant Resistance - Slew	
CV Voltage values.....	155	rate	74
Edit Sequence	179	Constant Resistance	
OCP test automation	189	Go/NoGo.....	74

Constant Voltage.....75	Over Current mode
Constant Voltage – Response	description..... 93
speed77	Over power mode description 94
Constant Voltage + Constant	Over protection
Current Mode.....76	configuration..... 197
Constant Voltage –Go/NoGo77	Over voltage mode
Constant Voltage -levels.....75	description..... 93
External Voltage Control.....100	Overview 16
File format.....110	Display Overview..... 27
File System.....104	Front panel 21
Go/NoGo.....84	LED display..... 39
Interface.....104	Load module..... 35
Memory data.....105	Rear Panel..... 31
Operating Configuration s –	Parallel Dynamic loading
Von Voltage.....95	description..... 91
Operating Configurations94	pass/fail test
Operating Configurations –	multiple step tutorial 113
CC vrange.....94	Power key 26
Operating Configurations –	Power supply
independent.....96	Safety information..... 8
Operating Configurations –	Power up..... 47
Load D-Time97	Power up sequence..... 47
Operating Configurations -	Preset data description..... 105
Short 96, 99	Preset key..... 24
Operating Configurations –	Program Chain mode
Step Resolution97	description..... 84
Parallel Dynamic Loading.....91	Program mode description 82
Preset data.....105	Protection All clear 200
Program Chain84	Quick save Presets to internal
Reverse voltage protection....94	memory..... 304
Run Program.....82	R/L key 35
save/recall All Chan.....108	Rack mount installation 45
SEQ data.....106	Range Chart..... 326
Sequences85	Recall factory defaults 307
Setup data.....106	Recall Memory data to USB.286
Trig Out.....87	Recall Presets - Framelink.... 306
USB save/recall108	Recall Setups - Framelink..... 305
Operation	Remote control
Contents127	Ethernet function check..... 260
Local load.....130	sockets configuration 257
Operation Environment 9	sockets function check 263, 266
Operation keys 24	Remote sense connections..... 54

Response speed constant	Sequences mode description	82
voltage mode description..	service contance point	320
77	Setting the date and time.....	250
Response time.....	Setup data description.....	106
217	Shift key.....	25
Reverse voltage protection.....	Short configuration	205
94	Short key	38
RS232 configuration.....	Shorting mode description	96, 99
251, 257	Slave knob	
RS-232C configuration.....	settings.....	237, 248
312	Slave knob	
Safety Instructions.....	description.....	38
6	Slew rage constant current	
Safety symbols.....	mode description.....	71
6	Slew rate Constant Resistance	
Save Memory data	mode description.....	74
271	Socket server function check	263, 266
Save Memory data to USB ...	Speaker Settings.....	228, 240
286	Specifications	334
Save Preset memory	RMX-4004	339
274	Static constant current mode	
Save presets to USB.....	description	70
292	Static/ Dynamic key	37
Save Sequences to USB.....	Step resolution.....	213
298	Step Resolution mode	
Save setup memory	description	97
276	Storage Environment	9
Save setup to USB	System Info	225
283	System Keys.....	22
Save to internal memory	Terminals	37
271, 278	Trig out.....	184
Save to internal setup memory	Trig out mode description.....	87
276	Tutorials	
Save/Recall	Local load	113
default USB path.....	Parallel load	117
278	Program.....	121
FrameLink Preset Recall	Single load.....	115
306	Tutorials	
FrameLink Setup Recall	Basic Operation	112
305	Channel control.....	124
Preset memory	Frame link	122
274	General configuration options	126
Quick save Presets to internal		
memory.....		
304		
Recall factory defaults		
307		
Recall Memory data to USB		
286		
Save Memory data to USB .		
286		
Save Preset Memory		
274		
Save presets to USB		
292		
Save SEQ (Sequences) to USB		
298		
Save setup to USB.....		
283		
Save to internal Memory.....		
278		
Save to setup Memory.....		
276		
Setup memory		
276		
USB path		
278		
Save/Recall		
Memory data		
271		
Save to internal Memory.....		
271		
Selector Knob.....		
24		
SEQ data description		
106		
Sequence editing/creating ...		
179		
Sequence mode description ...		
85		



Twisted pair description	51	Voltage sense terminal	36
UK power cord.....	11	Von voltage configuration ...	203
USB configuration.....	253	Von voltage mode description	95
USB path	278	Web server function check...	260
USB remote interface		Wire Connections.....	49
connection.....	319	Wire gauge.....	49
USB save/recall description	108	Wire induction	50
Utility Menu.	225	Wiring procedure.....	52
Voltage levels constant			
voltage mode description ..	75		