

Anritsu Advancing beyond

Spectrum Master™

Ultraportable Spectrum Analyzer

MS2760A

9 kHz to 32, 44, 50, 70, 90, 110, 145, 170 GHz

MS2762A

6 GHz to 32, 44, 50, 70, 90, 110, 145, 170 GHz



Introduction

Utilizing Anritsu's patented nonlinear transmission line (NLTL) technology, the Spectrum Master™ MS2760A and MS2762A ultraportable spectrum analyzer products deliver the best-in-class price/performance ratio unmatched by traditional benchtop instruments. This enables you to more efficiently advance your technology development and reduce your time to market. The Spectrum Master™ MS276xA series are pocket-sized, yet big on performance with leading dynamic range, sweep speed, and amplitude accuracy. The ultraportable size of these instruments enables a direct connection to almost any DUT, eliminating the need for lossy, expensive cables.

The 145 GHz and 170 GHz models are the world's first handheld millimeter-wave spectrum analyzers to provide broadband, continuous coverage from 9 kHz to 170 GHz. These are the world's first and only broadband spectrum analyzers that break through the 110 GHz barrier and enable research and development in the entire D band spectrum. They are perfect for advanced millimeter-wave applications like radio astronomy, automotive radar, antenna beam pattern testing, and more. The Spectrum Master™ MS2760A and MS2762A are USB-powered and controlled from a Windows-based PC, laptop, or tablet, making them uniquely flexible for use in the lab, on the manufacturing floor, or even in the field.

The Spectrum Master™ MS2760A models provide full broadband coverage from 9 kHz to 170 GHz with excellent dynamic range and DANL performance.

The Spectrum Master™ MS2762A models provide even better dynamic range and DANL performance than the Spectrum Master MS2760A models, for the most demanding sensitivity requirements, with frequency coverage starting at 6 GHz and a top frequency range of 170 GHz.

Spectrum Analyzer Highlights

- Measure: Channel Power, Adjacent Channel Power, Occupied Bandwidth
- Spectrum and Spectrogram Displays
- External 10 MHz Frequency Reference
- External TTL Trigger Input
- Resolution Bandwidth (RBW): 1 Hz to 3 MHz
- Phase Noise: -116 dBc/Hz @ 1 GHz, typical (MS2760A)
- Up to Six Spectrum Traces and Spectrogram Cursors, Three Trace Detectors, 12 Markers
- Dynamic Range: > 108 dB, typical at 70 GHz (MS2762A)
- DANL: as low as -142 dBm (MS2762A, 6 to 40 GHz typical)

Dimensions

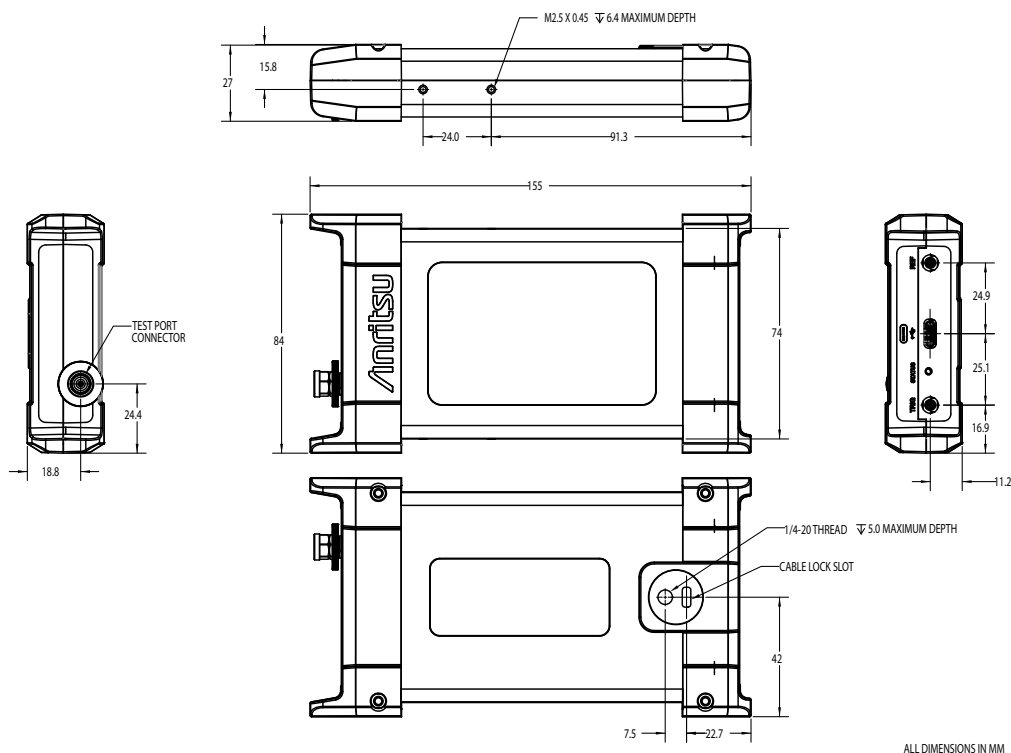

US Patents The MS276xA series instruments are protected by the following US patents: 6,894,581; 7,683,633; 8,417,189; 9,287,604

Table of Contents

Dimensions.....2
 Definitions.....3
 Spectrum Analyzer Measurements.....4
 MS2760A Spectrum Analyzer.....5
 MS2762A Spectrum Analyzer.....8
 General Specifications10
 Ordering Information11
 Standard Accessories12
 Optional Accessories.....12
 Manuals.....16

Definitions

	All specifications and characteristics apply to instruments under the following conditions, unless otherwise stated:
	<ul style="list-style-type: none"> • After 5 minutes of warm-up time, where the instrument is left in the ON state • When using the internal reference signal
Typical Specifications	Typical specifications are not tested and are not warranted. They are generally representative of characteristic performance. The following models have typical specifications in the following ranges: MS276xA-0044: 40 GHz to 44 GHz typical. MS276xA-0070: 67 GHz to 70 GHz typical. MS276xA-0170: 160 GHz to 170 GHz typical.
Calibration Cycle	Recommended calibration cycle is 12 months.
Time Base Error	Input Frequency × Frequency Reference Error All specifications subject to change without notice. For the most current data sheet, please visit www.anritsu.com



Spectrum Analyzer Measurements

Smart Measurements

Channel Power	Measures the total power in a specified bandwidth
Occupied Bandwidth	Measures 99 % to 1 % power channel bandwidth of a signal, and band edge frequency measurements
Adjacent Channel Power	Measures channel power of the adjacent channel and alternate channel

Setup Parameters

Frequency	Center/Start/Stop, Frequency Step, Frequency Offset
Span	Span, Span Up/Down, Full Span, Last Span, Zero Span
Bandwidth	RBW, Auto RBW, VBW, Auto VBW, VBW/RBW, Span/RBW, VBW Log/Lin Averaging
Amplitude	Reference Level, Scale / Division, Units, Ref Level Offset, IF Gain (On/Off), Image Reject (Normal/Low Only/High Only)

Sweep Functions

Sweep	Single/Continuous, Restart, Sweep Once, Sweep to N, Points, Minimum Capture Time
Sweep Update Indicator	Annotation along the graticule time axis to indicate position of trace sweep
Zero Span Sweep Time	0.02 ms to 60 s
Sweep (Trace) Points	Settable range from 10 to 10,001 points; the default is 501 points
Minimum Capture Time	0 s to 10 s
Sweep Time Accuracy	± 2% in Zero Span

Trace Functions

Traces	Up to six traces
Trace Type	Clear / Write, Trace Average, Max Hold, Min Hold, Rolling Average, Rolling Max Hold, Rolling Min Hold
Trace Mode	Active, Hold / View, Blank
Detector Type per Trace	Peak, RMS / Avg, Negative

Spectrogram

Trace Time Cursor	Up to six Time Cursors to recall historical trace data by trace number or time
Color Setup	Set Color Top/Bottom Range, Set Color Reference Hue

Marker Functions

Markers	Up to 12 Markers
Marker Mode	Normal, Delta, Fixed
Delta Marker	Relative to any Normal or Fixed Marker
Marker Function	None, Noise
Marker Trace	Assign Marker to any Trace
Peak Search	Peak Search, Next Peak, Next Peak Left, Next Peak Right, Next Point Left, Next Point Right
Peak Search Setup	Peak Threshold, Peak Excursion
Marker →	Mkr → Center, Mkr → Ref Level

Limit Line Functions

Limit Setup	Upper/Lower, Limit On/Off, Limit Alarm On/Off, Set Default Limit Line, Absolute/Relative
Limit Line Edit	Frequency, Amplitude, Add Point, Add Vertical, Delete Point, Next Point Left/Right
Limit Line Move	To Current Center Frequency, By dB or Hz, To Marker 1, Offset from Marker 1
Limit Line Envelope	Create Envelope, Update Envelope, Points (41 max), Offset, Shape Square/Slope



MS2760A Spectrum Analyzer

Frequency	Model Number	Frequency Range (usable to 0 Hz)
	MS2760A-0032	9 kHz to 32 GHz
	MS2760A-0044	9 kHz to 44 GHz
	MS2760A-0050	9 kHz to 50 GHz
	MS2760A-0070	9 kHz to 70 GHz
	MS2760A-0090	9 kHz to 90 GHz
	MS2760A-0110	9 kHz to 110 GHz
	MS2760A-0145	9 kHz to 145 GHz
	MS2760A-0170	9 kHz to 170 GHz
	Tuning Resolution	1 Hz
Internal 10 MHz Frequency Reference	Aging: ±1.0 ppm/year Accuracy: ±0.2 ppm (25 °C ± 25 °C) + aging	
Frequency Span	10 Hz to maximum frequency range of instrument	

Bandwidth		
Resolution Bandwidth (RBW)	1 Hz to 3 MHz (Span ≥10 Hz) Zero Span 5 kHz to 20 MHz	
Video Bandwidth (VBW)	1 Hz to 3 MHz (Span ≥10 Hz) Zero Span 5 kHz to 20 MHz	
VBW/Average Type	Linear / Log	
RBW Filters	Flat Top, Nuttall	
Shape Factor	<5:1 typical	

Amplitude Ranges		
Dynamic Range	> 103 dB typical at 70 GHz, 2/3 (TOI - DANL) in 1 Hz RBW	
Display Range	1 dB to 15 dB/div in 1 dB steps, ten divisions displayed	
Measurement Range	DANL to +10 dBm	
Reference Level Range	-120 dBm to +30 dBm	
Amplitude Units	dBm	
Maximum Safe Level Input	+30 dBm CW, ±10 VDC	

External Trigger		
Source	External, Free Run, Video, Periodic (0 s to 5 s)	
Delay	0 ms to 1670 ms; -60 s (up to sweep time) in zero span and video or external trigger	
Holdoff	0 ms to 5000 ms	
Slope	Rising, Falling, Both	
Hysteresis	0 dB to 200 dB	

Image Response The MS2760A employs unique software algorithms to minimize image responses that may appear under certain use cases when wideband modulated and multi-tone signals are being analyzed. Image rejection can be set to use upper or lower mixing products (no image rejection), or both for normal image rejection.

MS2760A Spectrum Analyzer (continued)

Spectral Purity – SSB Phase Noise	(dBc/Hz, 20 °C to 30 °C)							
	Offset	1 GHz (typical)	6 GHz (maximum)	6 GHz (typical)	30 GHz (maximum)	30 GHz (typical)	60 GHz (maximum)	60 GHz (typical)
1 kHz	-100	-80	-88	-66	-74	-60	-69	
10 kHz	-110	-95	-104	-81	-88	-75	-84	
100 kHz	-116	-95	-104	-81	-88	-75	-84	

Spurs

Residual Spurs	maximum (dBm)	typical (dBm)
10 MHz to 70 GHz	-85	-95
> 70 GHz to 90 GHz	-84	-95
> 90 GHz to 110 GHz	-81	-95
> 110 GHz to 145 GHz	-68	-85
> 145 GHz to 170 GHz	-64	-72
Input-related Spurious (-10 dBm CW input)		
@ 28 MHz	-50 dBc (70 MHz input signal)	
@ 35 MHz	-50 dBc (133 MHz input signal)	
@ 770 MHz	-35 dBc (3430 MHz, 4970 MHz, 7630 MHz input signal)	
@ 910 MHz	-35 dBc (4970 MHz, 6790 MHz input signal)	
All other input frequencies	<-60 dBc	
Zero Span	No image rejection is applied to the sweep while in zero span, therefore spurious impact may be different.	

Amplitude Accuracy

Frequency	(-10 dBm CW signal) 20 °C to 30 °C (after 30 minute warm-up)		0 °C to 50 °C (after 60 minute warm-up)	
	maximum (dB)	typical (dB)	maximum (dB)	typical (dB)
9 kHz to 644 MHz	±1.3	±0.5	±2.0	±0.5
> 644 MHz to 40 GHz	±1.8	±0.5	±3.0	±1.0
> 40 GHz to 70 GHz	±2.0	±0.5	±3.0	±1.0
> 70 GHz to 90 GHz	±2.2	±0.5	±3.0	±1.0
> 90 GHz to 110 GHz	±2.5	±0.5	±3.0	±1.0
> 110 GHz to 145 GHz	±3.5	±0.5	±4.0	±1.5
> 145 GHz to 170 GHz ^a	±3.5	±0.5	±4.0	±1.5

a. Amplitude Accuracy > 160 GHz typical

Displayed Average Noise Level (DANL) (RMS detection, VBW/Avg type = Log, IF Gain On), 1 Hz RBW

Frequency	maximum (dBm)	typical (dBm)
10 MHz to 670 MHz	-131	-134
> 670 MHz to 4 GHz	-136	-140
> 4 GHz to 40 GHz	-131	-134
> 40 GHz to 70 GHz	-128	-132
> 70 GHz to 90 GHz	-127	-130
> 90 GHz to 110 GHz	-123	-127
> 110 GHz to 145 GHz	-112	-120
> 145 GHz to 170 GHz	-107	-114

Third-Order Intercept (TOI) (IF Gain Off, typical, 0 dBm tones 1 MHz apart, 0 dBm reference level)

2 GHz	+35 dBm
18 GHz	+35 dBm
62 GHz	+25 dBm

Second Harmonic Distortion (at 1 GHz input)

0 dBm Input	-50 dBc maximum
-20 dBm Input	-60 dBc maximum



MS2760A Spectrum Analyzer (continued)

Input Match (typical)

Frequency	K Connector (2.92 mm) ^a		V Connector (1.85 mm) ^b		W1 Connector (1.0 mm)		0.8 mm Connector	
	VSWR	Return Loss	VSWR	Return Loss	VSWR	Return Loss	VSWR	Return Loss
9 kHz to 12.4 GHz	1.29:1	18 dB	1.29:1	18 dB	1.29:1	18 dB	1.29:1	18 dB
> 12.4 GHz to 26.5 GHz	1.67:1	12 dB	1.43:1	15 dB	1.67:1	12 dB	1.67:1	12 dB
> 26.5 GHz to 40 GHz	1.67:1	12 dB	1.58:1	13 dB	1.67:1	12 dB	1.67:1	12 dB
> 40 GHz to 50 GHz	1.67:1	12 dB	1.67:1	12 dB	1.67:1	12 dB	1.67:1	12 dB
> 50 GHz to 70 GHz	-	-	2.10:1	9 dB	2.10:1	9 dB	2.10:1	9 dB
> 70 GHz to 110 GHz	-	-	-	-	2.10:1	9 dB	2.32:1	8 dB
> 110 GHz to 145 GHz	-	-	-	-	-	-	3.56:1	5 dB
> 145 GHz to 170 GHz	-	-	-	-	-	-	4.42:1	4 dB

a. Compatible with SMA and 3.5 mm connectors.

b. Compatible with 2.4 mm connectors.



MS2762A Spectrum Analyzer

Frequency	Model Number	Frequency Range
	MS2762A-0032	6 GHz to 32 GHz
	MS2762A-0044	6 GHz to 44 GHz
	MS2762A-0050	6 GHz to 50 GHz
	MS2762A-0070	6 GHz to 70 GHz
	MS2762A-0090	6 GHz to 90 GHz
	MS2762A-0110	6 GHz to 110 GHz
	MS2762A-0145	6 GHz to 145 GHz
	MS2762A-0170	6 GHz to 170 GHz
	Tuning Resolution	1 Hz
Internal 10 MHz Frequency Reference	Aging: ± 1.0 ppm/year Accuracy: ± 0.2 ppm ($25\text{ }^{\circ}\text{C} \pm 25\text{ }^{\circ}\text{C}$) + aging	
Frequency Span	10 Hz to maximum frequency range of instrument	

Bandwidth

Resolution Bandwidth (RBW)	1 Hz to 3 MHz (Span ≥ 10 Hz) Zero Span 5 kHz to 20 MHz
Video Bandwidth (VBW)	1 Hz to 3 MHz (Span ≥ 10 Hz) Zero Span 5 kHz to 20 MHz
VBW/Average Type	Linear / Log
RBW Filters	Flat Top, Nuttall
Shape Factor	<5:1 typical

Amplitude Ranges

Dynamic Range	> 108 dB typical at 70 GHz, 2/3 (TOI - DANL) in 1 Hz RBW
Display Range	1 dB to 15 dB/div in 1 dB steps, ten divisions displayed
Measurement Range	DANL to 0 dBm
Reference Level Range	-120 dBm to +30 dBm
Amplitude Units	dBm
Maximum Safe Level Input	+18 dBm CW, ± 10 VDC

External Trigger

Source	External, Free Run, Video, Periodic (0 s to 5 s)
Delay	0 ms to 1670 ms; -60 s (up to sweep time) in zero span and video or external trigger
Holdoff	0 ms to 5000 ms
Slope	Rising, Falling, Both
Hysteresis	0 dB to 200 dB

Image Response The MS2762A employs unique software algorithms to minimize image responses that may appear under certain use cases when wideband modulated and multi-tone signals are being analyzed. Image rejection can be set to use upper or lower mixing products (no image rejection), or both for normal image rejection.



MS2762A Spectrum Analyzer (continued)

Spectral Purity – SSB Phase Noise

Offset	(dBc/Hz, 20 °C to 30 °C)						
	7 GHz (maximum)	7 GHz (typical)	30 GHz (maximum)	30 GHz (typical)	60 GHz (maximum)	60 GHz (typical)	
1 kHz	-80	-89	-66	-74	-60	-69	
10 kHz	-93	-97	-81	-88	-75	-84	
100 kHz	-94	-98	-81	-88	-75	-84	

Spurs

Residual Spurs	maximum (dBm)	typical (dBm)
6 GHz to 70 GHz	-85	-95
> 70 GHz to 90 GHz	-84	-95
> 90 GHz to 110 GHz	-81	-95
> 110 GHz to 145 GHz	-68	-85
> 145 GHz to 170 GHz	-67	-85
Input-related Spurious	<-60 dBc (-20 dBm CW input)	
Zero Span	No image rejection is applied to the sweep while in zero span, therefore spurious impact may be different.	

Amplitude Accuracy

Frequency	(-10 dBm CW signal) 20 °C to 30 °C (after 30 minute warm-up)		0 °C to 50 °C (after 60 minute warm-up)	
	maximum (dB)	typical (dB)	maximum (dB)	typical (dB)
≥ 6 GHz to 40 GHz	±1.8	±0.5	±3.0	±1.0
> 40 GHz to 70 GHz	±2.0	±0.5	±3.0	±1.0
> 70 GHz to 90 GHz	±2.2	±0.5	±3.0	±1.0
> 90 GHz to 110 GHz	±2.5	±0.5	±3.0	±1.0
> 110 GHz to 145 GHz	±3.5	±0.5	±4.0	±1.5
> 145 GHz to 170 GHz ^a	±3.5	±0.5	±4.0	±1.5

a. Amplitude Accuracy > 160 GHz typical

Displayed Average Noise Level (DANL) (RMS detection, VBW/Avg type = Log, IF Gain On, 1 Hz RBW)

Frequency	maximum (dBm)	typical (dBm)
> 6 GHz to 40 GHz	-135	-142
> 40 GHz to 70 GHz	-137	-141
> 70 GHz to 90 GHz	-136	-141
> 90 GHz to 110 GHz	-132	-136
> 110 GHz to 145 GHz	-119	-129
> 145 GHz to 170 GHz	-114	-122

Third-Order Intercept (TOI) (IF Gain Off, typical, -10 dBm tones 1 MHz apart, -10 dBm reference level)

18 GHz	+22 dBm
62 GHz	+21 dBm

Second Harmonic Distortion (at 7 GHz input)

-25 dBm Input	-50 dBc maximum
---------------	-----------------

Input Match (typical)

Frequency	K Connector (2.92 mm) ^a		V Connector (1.85 mm) ^b		W1 Connector (1.0 mm)		0.8 mm Connector	
	VSWR	Return Loss	VSWR	Return Loss	VSWR	Return Loss	VSWR	Return Loss
6 GHz to 12.4 GHz	1.92:1	10 dB	1.92:1	10 dB	1.92:1	10 dB	1.92:1	10 dB
> 12.4 GHz to 50 GHz	1.78:1	11 dB	1.78:1	11 dB	1.78:1	11 dB	1.78:1	11 dB
> 50 GHz to 70 GHz	-	-	2.32:1	8 dB	2.32:1	8 dB	2.32:1	8 dB
> 70 GHz to 110 GHz	-	-	-	-	3.01:1	9 dB	3.01:1	6 dB
> 110 GHz to 145 GHz	-	-	-	-	-	-	4.42:1	4 dB
> 145 GHz to 170 GHz	-	-	-	-	-	-	4.42:1	4 dB

a. Compatible with SMA and 3.5 mm connectors.

b. Compatible with 2.4 mm connectors.

General Specifications

Setup Parameters		
System Information	Connected To, Manufacturer, Model Number, Serial Number, Server Version, Client Version, Frequency	
Settings Display	Color Theme (Default/Light)	
Settings Screenshot	Capture Region (Entire Application/Graphs Only), Color (Standard/Printable), Annotations (Footer/Header), Directory, File Naming (Automatic Timestamp/Manual)	
File	Quick Save, Save As, Recall, Save On Event, Browse Files	
Save On Event	Limit Crossed (Off/Single/Continuous), Sweep End (Off/Single/Continuous), Interval, Clear All Events	
Connectors		
RF In	32 GHz and 44 GHz Instruments: K Connector (2.92 mm), male 50 Ω 50 GHz and 70 GHz Instruments: V Connector (1.85 mm), male 50 Ω 90 GHz and 110 GHz Instruments: W Connector (1.0 mm), male 50 Ω 145 GHz and 170 GHz Instruments: 0.8 mm Connector, (0.8mm), male 50 Ω	
USB Interface	USB 3.0, Type C Connector	
External Reference In	MCX(f), 50 Ω , 10 MHz	
External Trigger In	MCX(f), 50 Ω , TTL Levels	
Computer Requirement		
Display Resolution	16:9 / 16:10 Aspect Ratio (>1280 x 720 / 1280 x 800)	
Operating System	Windows® 7, 8.1, 10; 64-bit	
Recommended Minimum Configuration	Quad Core i7 fourth generation or higher CPU, 16 GB RAM, 128 GB Data Storage, USB 3.0	
Regulatory Compliance		
	(not including Windows Tablet/Laptop/PC)	
European Union	EMC 2014/30/EU, EN 61326:2013, CISPR 11/EN 55011, IEC/EN 61000-4-2/3/4/5/6/8/11 Low Voltage Directive 2014/35/EU Safety EN 61010-1:2010 RoHS Directive 2011/65/EU applies to instruments with CE marking placed on the market after July 22, 2017	
United Kingdom	EMC SI 2016/1091; BS EN 55011 & BS 61000-4-2/3/4/5/6/8/11 Consumer Protection (Safety) SI 2016/1101; BS EN 61010-1:2010 Environmental Protection SI 2012/3032;2011/65/EU & 2015/863	
Australia and New Zealand	RCM AS/NZS 4417:2012	
South Korea	KCC-R-R-A2J-1015	
Canada	ICES-1(A)/NMB-1(A)	
Environmental		
Operating Temperature Range	MIL-PRF-28800F Class 3 (not including Windows Tablet/Laptop/PC) 0 °C to 50 °C	
Storage Temperature Range	-40 °C to 71 °C	
Maximum Relative Humidity	95 % RH at 30 °C, non-condensing	
Vibration, Sinusoidal	5 Hz to 55 Hz	
Vibration, Random	10 Hz to 500 Hz	
Half Sine Shock	30 g _n	
Altitude	4600 meters, operating and non-operating	
Explosive Atmosphere	MIL-PRF-28800F Section 4.5.6.3 MIL-STD-810G, Method 511.5, Procedure 1	
Warranty		
Duration	Standard three-year warranty	
Size and Weight (not including Windows Tablet/Laptop/PC)		
Size	155 mm x 84 mm x 27 mm (6.1 in x 3.3 in x 1.1 in)	
Weight	255 g (9.0 oz)	

Ordering Information

Models and Options





Model Number	Description
MS2760A-0032	Spectrum Master, Ultraportable Spectrum Analyzer, 9 kHz to 32 GHz
MS2760A-0044	Spectrum Master, Ultraportable Spectrum Analyzer, 9 kHz to 44 GHz
MS2760A-0050	Spectrum Master, Ultraportable Spectrum Analyzer, 9 kHz to 50 GHz
MS2760A-0070	Spectrum Master, Ultraportable Spectrum Analyzer, 9 kHz to 70 GHz
MS2760A-0090	Spectrum Master, Ultraportable Spectrum Analyzer, 9 kHz to 90 GHz
MS2760A-0110	Spectrum Master, Ultraportable Spectrum Analyzer, 9 kHz to 110 GHz
MS2760A-0145	Spectrum Master, Ultraportable Spectrum Analyzer, 9 kHz to 145 GHz
MS2760A-0170	Spectrum Master, Ultraportable Spectrum Analyzer, 9 kHz to 170 GHz
MS2762A-0032	Spectrum Master, Ultraportable Spectrum Analyzer, 6 GHz to 32 GHz
MS2762A-0044	Spectrum Master, Ultraportable Spectrum Analyzer, 6 GHz to 44 GHz
MS2762A-0050	Spectrum Master, Ultraportable Spectrum Analyzer, 6 GHz to 50 GHz
MS2762A-0070	Spectrum Master, Ultraportable Spectrum Analyzer, 6 GHz to 70 GHz
MS2762A-0090	Spectrum Master, Ultraportable Spectrum Analyzer, 6 GHz to 90 GHz
MS2762A-0110	Spectrum Master, Ultraportable Spectrum Analyzer, 6 GHz to 110 GHz
MS2762A-0145	Spectrum Master, Ultraportable Spectrum Analyzer, 6 GHz to 145 GHz
MS2762A-0170	Spectrum Master, Ultraportable Spectrum Analyzer, 6 GHz to 170 GHz

Option Number

MS276xA-0032-0098	
MS276xA-0044-0098	
MS276xA-0050-0098	
MS276xA-0070-0098	Standard Calibration (ISO/IEC 17025 and ANSI/NCSL Z540-1)
MS276xA-0090-0098	
MS276xA-0110-0098	
MS276xA-0145-0098	
MS276xA-0170-0098	
MS276xA-0032-0099	
MS276xA-0044-0099	
MS276xA-0050-0099	
MS276xA-0070-0099	Premium Calibration (ISO/IEC 17025 and ANSI/NCSL Z540-1 plus test data)
MS276xA-0090-0099	
MS276xA-0110-0099	
MS276xA-0145-0099	
MS276xA-0170-0099	
MS2762A-0032-0098	
MS2762A-0044-0098	
MS2762A-0050-0098	
MS2762A-0070-0098	Standard Calibration (ISO/IEC 17025 and ANSI/NCSL Z540-1)
MS2762A-0090-0098	
MS2762A-0110-0098	
MS2762A-0145-0098	
MS2762A-0170-0098	
MS2762A-0032-0099	
MS2762A-0044-0099	
MS2762A-0050-0099	
MS276xA-0070-0099	Premium Calibration (ISO/IEC 17025 and ANSI/NCSL Z540-1 plus test data)
MS2762A-0090-0099	
MS2762A-0110-0099	
MS2762A-0145-0099	
MS2762A-0170-0099	

Standard Accessories (included with instrument)





Accessory	Description
	2000-1859-R USB 3.0 Type C to Type A Cable, 1 m
Certificate of Calibration and Conformance	

Accessory	Description
	2000-1605-R BNC(m) to MCX(m) Cable (qty 2)

Optional Accessories

Coaxial Adapters

Accessory	Description
	34VFK50A DC to 43.5 GHz, V(f) to K(m), 50 Ω
	34VFKF50A DC to 43.5 GHz, V(f) to K(f), 50 Ω
	34VV50 DC to 65 GHz, V(m) to V(m), 50 Ω
	34VVF50 DC to 65 GHz, V(f) to V(m), 50 Ω
	34VVFV50 DC to 65 GHz, V(f) to V(f), 50 Ω
	34WV50 Precision Adapter, DC to 65 GHz, W1(m) to V(m), 50 Ω
	34WVF50 Precision Adapter, DC to 65 GHz, W1(m) to V(f), 50 Ω
	34WV50 Precision Adapter, DC to 65 GHz, W1(f) to V(m), 50 Ω
	34WVF50 Precision Adapter, DC to 65 GHz, W1(f) to V(f), 50 Ω
	33WW50 W1(m) to W1(m)
	33WVF50 W1(m) to W1(f)



Accessory	Description
	33W.850 Calibration Grade Adapter, W1(m) to 0.8 mm (m), DC to 110 GHz, 50 Ω
	33W.8F50 Calibration Grade Adapter, W1(m) to 0.8 mm (f), DC to 110 GHz, 50 Ω
	33WF.850 Calibration Grade Adapter, W1(f) to 0.8 mm (m), DC to 110 GHz, 50 Ω
	33WF.8F50 Calibration Grade Adapter, W1(f) to 0.8 mm (f), DC to 110 GHz, 50 Ω
	33.8.850 Calibration Grade Adapter, 0.8 mm (m) to 0.8 mm (m), DC to 145 GHz, 50 Ω
	33.8.8F50 Calibration Grade Adapter, 0.8 mm (m) to 0.8 mm (f), DC to 145 GHz, 50 Ω
	33.8F.8F50 Calibration Grade Adapter, 0.8 mm (f) to 0.8 mm (f), DC to 145 GHz, 50 Ω
	2000-1880-R DC to 18 GHz, N(m) to V(f), 50 Ω
	2000-1881-R DC to 18 GHz, N(f) to V(f), 50 Ω
	K222B DC to 40 GHz, K(f) to K(f), 50 Ω
	33WVF50 W1(f) to W1(f)

Fixed Attenuators		Accessory	
Accessory	Description	Accessory	Description
	43KC-3 Precision, DC to 26.5 GHz, 1W, 3 dB, K(m) to K(f)		41VA-3 Precision, DC to 70 GHz, 1W, 3 dB, V(m) to V(f)
	43KC-6 Precision, DC to 26.5 GHz, 1W, 6 dB, K(m) to K(f)		41VA-6 Precision, DC to 70 GHz, 1W, 6 dB, V(m) to V(f)
	43KC-10 Precision, DC to 26.5 GHz, 1W, 10 dB, K(m) to K(f)		41VA-10 Precision, DC to 70 GHz, 1W, 10 dB, V(m) to V(f)
	43KC-20 Precision, DC to 26.5 GHz, 1W, 20 dB, K(m) to K(f)		41VA-20 Precision, DC to 70 GHz, 1W, 20 dB, V(m) to V(f)
	41KB-3 Precision, DC to 26.5 GHz, 1W, 3 dB, K(m) to K(f)		41VA-30 Precision, DC to 70 GHz, 1W, 30 dB, V(m) to V(f)
	41KB-6 Precision, DC to 26.5 GHz, 1W, 6 dB, K(m) to K(f)		41VA-40 Precision, DC to 70 GHz, 1W, 40 dB, V(m) to V(f)
	41KB-10 Precision, DC to 26.5 GHz, 1W, 10 dB, K(m) to K(f)		41W-3 DC to 110 GHz, 0.2 W, 3 dB, W1(m) to W1(f), 50 Ω
	41KB-20 Precision, DC to 26.5 GHz, 1W, 20 dB, K(m) to K(f)		41W-6 DC to 110 GHz, 0.2 W, 6 dB, W1(m) to W1(f), 50 Ω
	41KC-3 Precision, DC to 40 GHz, 1W, 3 dB, K(m) to K(f)		41W-10 DC to 110 GHz, 0.2 W, 10 dB, W1(m) to W1(f), 50 Ω
	41KC-6 Precision, DC to 40 GHz, 1W, 6 dB, K(m) to K(f)		
	41KC-10 Precision, DC to 40 GHz, 1W, 10 dB, K(m) to K(f)		
	41KC-20 Precision, DC to 40 GHz, 1W, 20 dB, K(m) to K(f)		

Miscellaneous Components

Accessory	Description
	W240A Precision Power Divider, DC to 110 GHz, W1(f) input, W1(f) outputs, 3 resistor, 50 Ω
	W241A Precision Power Splitter, DC to 110 GHz, W1(m) input, W1(f) outputs, 2 resistor, 50 Ω
	MN25110A Precision Directional Coupler, 20 GHz to 110 GHz, W1(f) input, W1(f) output, W1(f) coupled port, 50 Ω
	2000-1929-R Low Noise Amplifier, 18 GHz to 42 GHz, 28 dB Gain, V(m) to V(f)
	2000-1930-R Low Noise Amplifier, 18 GHz to 42 GHz, 28 dB Gain, K(m) to K(f)

Accessory Description

	01-201 Torque Wrench, 0.9 N*m (8 lbf*in) for K, V, SMA, 3.5 mm, 2.4 mm connectors
	01-504 Torque Wrench, 0.45 N*m (4 lbf*in) for W1, 1.0 mm connectors
	01-524 Torque Wrench, 0.45 N*m (4 lbf*in) for 0.8 mm connectors

Precision Waveguide Coaxial Adapters (right angle)

Accessory	Description
	35WR42KF 18 GHz to 26.5 GHz, WR42 to K(f)
	35WR28KF 26.5 GHz to 40 GHz, WR28 to K(f)
	35WR22VF 33 GHz to 50 GHz, WR22 to V(f)
	35WR19VF 40 GHz to 60 GHz, WR19 to V(f)

Accessory	Description
	35WR15VF 50 GHz to 65 GHz, WR15 to V(f)
	35WR10WF 75 GHz to 110 GHz, WR10 to W1(f)
	SC7442 60 GHz to 90 GHz, WR12 to W1(f)

Waveguide to Coaxial End Launch Adapters (straight through)

Accessory	Description
	2000-1889-R 17.6 GHz to 26.7 GHz, WR42 to K(f)
	2000-1890-R 26.4 GHz to 40.1 GHz, WR28 to K(f)
	1091-460-R 17.6 GHz to 26.7 GHz, WR42 to V(f)
	1091-459-R 26.4 GHz to 40.1 GHz, WR28 to V(f)
	1091-458-R 33.0 GHz to 50.1 GHz, WR22 to V(f)
	SM7060 110 GHz to 145 GHz, WR6 to 0.8 mm(f)

Accessory	Description
	1091-457-R 39.3 GHz to 59.7 GHz, WR19 to V(f)
	1091-456-R 49.9 GHz to 67.0 GHz, WR15 to V(f)
	1091-402-R 49.9 GHz to 75.8 GHz, WR15 to W1(f)
	1091-401-R 60.5 GHz to 92.0 GHz, WR12 to W1(f)
	1091-400-R 73.8 GHz to 110 GHz, WR10 to W1(f)



Directional Horn Antennas

Accessory	Description
	2000-1867-R 17.6 GHz to 26.7 GHz, WR42, 25 dBi gain
	2000-1868-R 26.4 GHz to 40.1 GHz, WR28, 25 dBi gain
	2000-1869-R 33.0 GHz to 50.1 GHz, WR22, 25 dBi gain
	2000-1870-R 39.3 GHz to 59.7 GHz, WR19, 25 dBi gain
	2000-1871-R 49.9 GHz to 75.8 GHz, WR15, 25 dBi gain
	2000-1872-R 60.5 GHz to 92.0 GHz, WR12, 25 dBi gain
	2000-1873-R 73.8 GHz to 112.0 GHz, WR10, 25 dBi gain

Accessory	Description
	2000-2003-R 24 GHz to 40 GHz, WR28, 19 dBi gain (small form factor assembly with K(f) adapter, mounting bracket, and case)

Test Port Cables (Armored, Semi-rigid)

Accessory	Description
	3670K50A-1 K(f) to K(m), 30.48 cm
	3670K50A-2 K(f) to K(m), 60.96 cm
	3670V50A-1 DC to 70 GHz, V(f) to V(m), 30.5 cm (1 ft)
	3670V50A-2 DC to 70 GHz, V(f) to V(m), 61.0 cm (2 ft)
	3670W50-1 DC to 110 GHz, W1(m) to W1(f), 10 cm
	3670W50-2 DC to 110 GHz, W1(m) to W1(f), 16 cm

Accessory	Description
	3671W1-50-1 DC to 110 GHz, Flexible, W1(f) to W1(m), 10 cm
	3671W1-50-2 DC to 110 GHz, Flexible, W1(f) to W1(m), 13 cm
	3671W1-50-3 DC to 110 GHz, Flexible, W1(f) to W1(m), 16 cm
	3670.850-1 Test Port Cable, Armored, Semi-rigid, 0.8 mm(m) to 0.8 mm(f) 10 cm
	3670.850-2 Test Port Cable, Armored, Semi-rigid, 0.8 mm(m) to 0.8 mm(f) 16 cm
	3671W1-50-3 DC to 110 GHz, Flexible, W1(f) to W1(m), 16 cm

USB Cable Extender

Accessory	Description
	2000-1888-R USB 3.0 Powered Extension Cable, 10 m, (32 ft) (up to two can be used in series for a total length of 20 m)

Accessory	Description
	2000-1918-R 4-port 200 m USB Multimode Fiber Extender System

Manuals (available at www.anritsu.com)

Part Number	Description
10580-00427	MS276xA Spectrum Master User Guide

Notes

Training at Anritsu

Anritsu has designed courses to help you stay up-to-date with technologies important to your job. For available training courses, visit: www.anritsu.com and search for training and education.



• United States

Anritsu Americas Sales Company
450 Century Parkway, Suite 190,
Allen, TX 75013, U.S.A.
Phone: +1-800-Anritsu (1-800-267-4878)

• Canada

**Anritsu Electronics Ltd.
Americas Sales and Support**
450 Century Parkway, Suite 190,
Allen, TX 75013, U.S.A.
Phone: +1-800-Anritsu (1-800-267-4878)

• Brazil

Anritsu Eletronica Ltda.
Praça Amadeu Amaral, 27 - 1 Andar
01327-010 - Bela Vista - Sao Paulo - SP, Brazil
Phone: +55-11-3283-2511
Fax: +55-11-3288-6940

• Mexico

Anritsu Company, S.A. de C.V.
Blvd Miguel de Cervantes Saavedra #169 Piso 1,
Col. Granada, Mexico, Ciudad de Mexico,
11520, MEXICO
Phone: +52-55-4169-7104

• United Kingdom

Anritsu EMEA Ltd.
200 Capability Green,
Luton, Bedfordshire, LU1 3LU, U.K.
Phone: +44-1582-433200
Fax: +44-1582-731303

• France

Anritsu S.A.
12 avenue du Québec, Immeuble Goyave,
91140 VILLEBON SUR YVETTE, France
Phone: +33-1-60-92-15-50

• Germany

Anritsu GmbH
Nemetschek Haus, Konrad-Zuse-Platz 1,
81829 München, Germany
Phone: +49-89-442308-0
Fax: +49-89-442308-55

• Italy

Anritsu S.r.l.
Spaces Eur Arte, Viale dell'Arte 25, 00144 Roma, Italy
Phone: +39-6-509-9711

List Revision Date: 20230407

• Sweden

Anritsu AB
Kistagången 20 B, 2 tr, 164 40 Kista, Sweden
Phone: +46-8-534-707-00

• Finland

Anritsu AB
Technopolis Aviapolis, Teknobulevardi 3-5 (D208.5),
FI-01530 Vantaa, Finland
Phone: +358-20-741-8100

• Denmark

Anritsu A/S
c/o Regus Winghouse, Ørestads Boulevard 73, 4th
floor,
2300 Copenhagen S, Denmark
Phone: +45-7211-2200

• Spain

**Anritsu EMEA Ltd.
Representation Office in Spain**
Paseo de la Castellana, 141,
Planta 5, Edificio Cuzco IV
28046, Madrid, Spain
Phone: +34-91-572-6761

• Austria

Anritsu EMEA GmbH
Am Belvedere 10, A-1100 Vienna, Austria
Phone: +43-(0)1-717-28-710

• United Arab Emirates

**Anritsu EMEA Ltd.
Anritsu A/S**
Office No. 164, Building 17, Dubai Internet City
P. O. Box - 501901, Dubai, United Arab Emirates
Phone: +971-4-3758479

• India

Anritsu India Private Limited
6th Floor, Indiqube ETA, No.38/4, Adjacent to EMC2,
Doddanekundi, Outer Ring Road,
Bengaluru - 560048, India
Phone: +91-80-6728-1300
Fax: +91-80-6728-1301

• Singapore

Anritsu Pte. Ltd.
11 Chang Charn Road, #04-01, Shriro House
Singapore 159640
Phone: +65-6282-2400
Fax: +65-6282-2533

• Vietnam

Anritsu Company Limited
16th Floor, Peakview Tower, 36 Hoang Cau Street,
O Cho Dua Ward, Dong Da District, Hanoi, Vietnam
Phone: +84-24-3201-2730

• P.R. China (Shanghai)

Anritsu (China) Co., Ltd.
Room 2701-2705, Tower A, New Caohejing
International Business Center No. 391 Gui Ping Road
Shanghai, 200233, P.R. China
Phone: +86-21-6237-0898
Fax: +86-21-6237-0899

• P.R. China (Hong Kong)

Anritsu Company Ltd.
Unit 1006-7, 10/F., Greenfield Tower, Concordia Plaza,
No. 1 Science Museum Road, Tsim Sha Tsui East,
Kowloon, Hong Kong, P.R. China
Phone: +852-2301-4980
Fax: +852-2301-3545

• Japan

Anritsu Corporation
8-5, Tamura-cho, Atsugi-shi, Kanagawa, 243-0016
Japan
Phone: +81-46-296-6509
Fax: +81-46-225-8352

• South Korea

Anritsu Corporation, Ltd.
5FL, 235 Pangyoyeok-ro, Bundang-gu, Seongnam-si,
Gyeonggi-do 13494, South Korea
Phone: +82-31-696-7750
Fax: +82-31-696-7751

• Australia

Anritsu Pty. Ltd.
Unit 20, 21-35 Ricketts Road,
Mount Waverley, Victoria 3149, Australia
Phone: +61-3-9558-8177
Fax: +61-3-9558-8255

• Taiwan

Anritsu Company Inc.
7F, No. 316, Sec. 1, NeiHu Rd., Taipei 114, Taiwan
Phone: +886-2-8751-1816
Fax: +886-2-8751-1817