

Radio Communication Test Station

MT8000A



All-in-One 5G NR RF Measurements, Protocol Tests and Application Tests

5G, Official Start

Anritsu is releasing its new platform for developing 5G communications terminals, chipsets and devices.

With support for both RF measurements and protocol tests, this all-in-one platform can be configured easily for various tests, including RF measurements, protocol and application tests matching the module construction.

Anritsu — the leader in 4G testing — is also now taking the lead in 5G.



Flexibility

Measurement Module Configurations Matching Test Application

The all-in-one MT8000A supports RF measurements, protocol and application tests with a single unit while its flexible expandability not only meets future wider application needs but also helps cut-back new instrument investment and training costs for more efficient cost-performance.

FR1 (to 7.125 GHz) — FR2

Comprehensive Test Coverage from mmWave RF Measurements to Beamforming Tests

As well as supporting the FR1 (to 7.125 GHz) used by 5G, combining the MT8000A with OTA chambers also supports the FR2 (mmWave band) RF measurements and beamforming tests.

MT8000A



Software

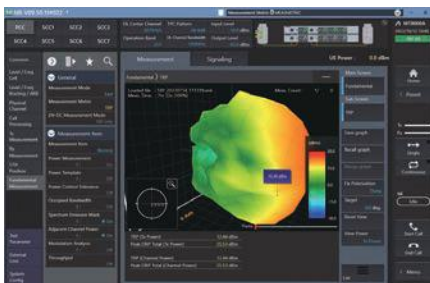

RF Measurement Software

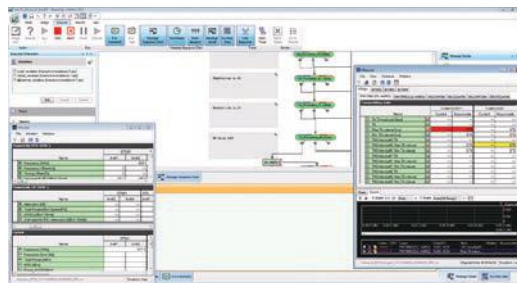

RTD for 5G NR

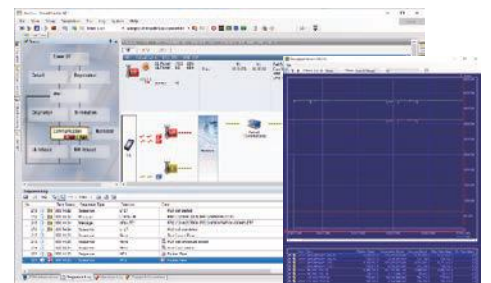

Function and Application Tests Software:
SmartStudio NR
SmartStudio NR IP Performance

*: The design, explanation and appearance are subject to change without notice.

The Wireless Communication Test Station for 5G Device Development

Radio Communication Test Station MT8000A Features

All-in-One Support for FR1 (to 7.125 GHz) and Millimeter Wave Bands

With a 5G base station emulation function, a single MT8000A test platform supports both the FR1 (to 7.125 GHz) and the FR2 (28 GHz/39 GHz/43.5 GHz) bands used by 5G. Combining it with the RF Chamber enables both millimeter wave band RF measurements and beamforming tests using call connections specified by 3GPP.

Example of Supported Band

Band	n71 (600 MHz)	n41 (2.5 GHz)	n78-79 (3.5 G/4.5 GHz)	n257 (28 GHz)	n260 (39 GHz)	n259 (43.5 GHz)
	✓	✓	✓	✓	✓	✓

*: Please enquire about other supported bands.

Flexible Platform using Modular Architecture

Both Non-signalling and Signalling RF TRx measurements and protocol tests are supported by switching the test application at the common hardware platform.

In addition to supporting high-order MIMO (4x4 MIMO) and carrier aggregation (8CA) for implementing enhanced Mobile Broadband (eMBB), new 5G test needs, such as Ultra-Reliable and Low Latency Communications (URLLC) and massive Machine Type Communications (mMTC) are supported by the leading-edge design with flexibility and expendability based on the modular architecture.

A futureproof, flexible test environment is provided for a wide application range.

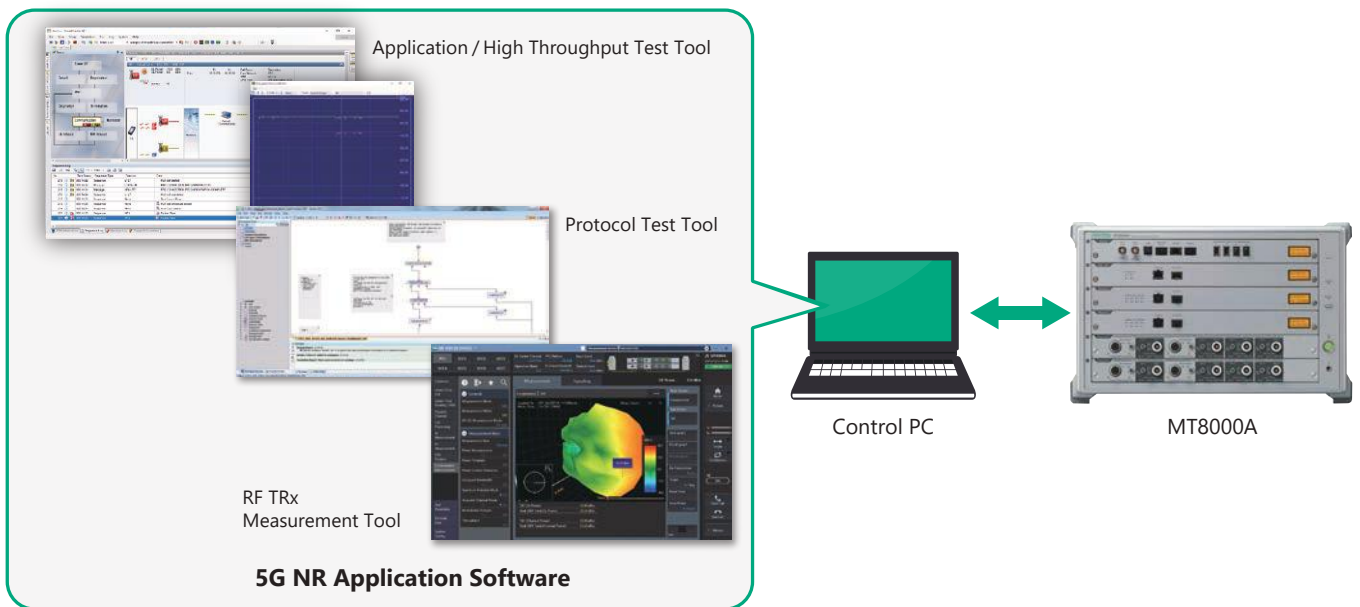

The Wireless Communication Test Station for 5G Device Development

Radio Communication Test Station MT8000A Features

Supports Existing LTE Test Environment

A comprehensive test environment is provided by using Anritsu's LTE test platform offering leading-edge functions based on the company's long experience in this market. Easy configuration of a linked environment for simulating the 5G Non-Standalone (NSA) mode with LTE makes best use of measurement assets, such as the customer's test environment and test scenarios. (For RF, Protocol and Application tests, it is also possible to build an LTE test environment using the MT8000A.)

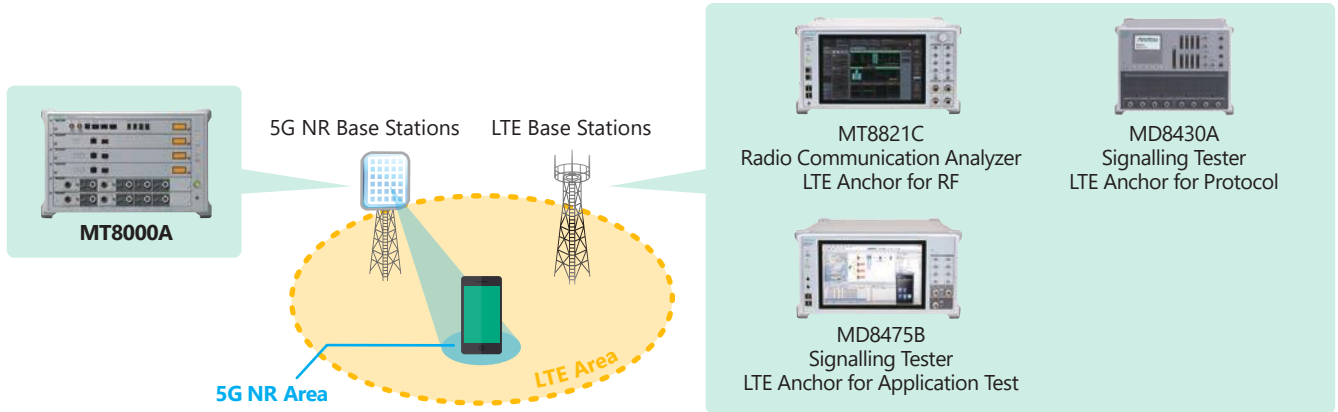

Radio Communication Test Station MT8000A Features

RF TRX Measurement GUI : MX800010A

3GPP RF Tests

Development and testing of mobile terminals and chipsets as well as network operator acceptance inspection tests, etc., are essential for evaluating compliance of the mobile terminal TRx performance with the 3GPP standards. With the increasing complexity of mobile terminal circuitry due to the use of more frequency bands, such as mmWave, the MX800010A software is an ideal solution for testing various aspects in support of 5G NR Mobile terminal RF TRx tests.

Flexible Parameter Settings

The easy to change MX800010A parameter settings also support RF parametric tests and simplified protocol tests.

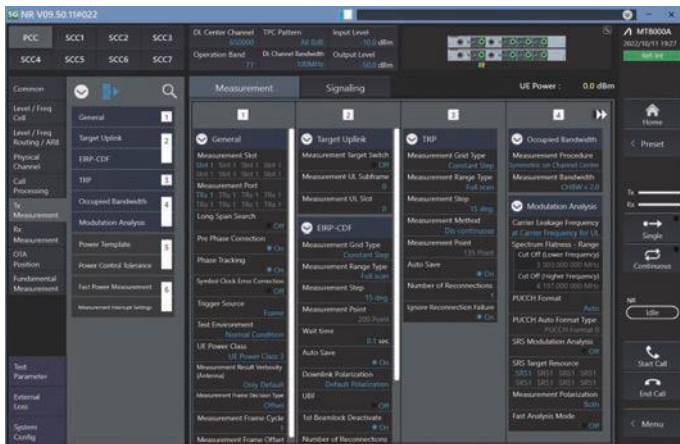

Typical Parameters (5G NR)

Supports NSA Mode Tests

The 5G NR Non-Standalone (NSA) mode is supported. In the NSA mode, as well as using the Radio Communication Analyzer MT8821C as an LTE Anchor, the MT8000A with MX800010A-070 software option also supports NSA call connection and RF tests.

Enhanced GUI for Efficient Operability

The MX800010A has the same easy to use and easy to understand GUI as the MT8821C. In addition to one-touch switching of listed and individual graph displays as well as summary and detailed displays of measurement results, the MX800010A supports convenient parameter setting functions such as, parameter searching and bookmarking for frequently used parameters.

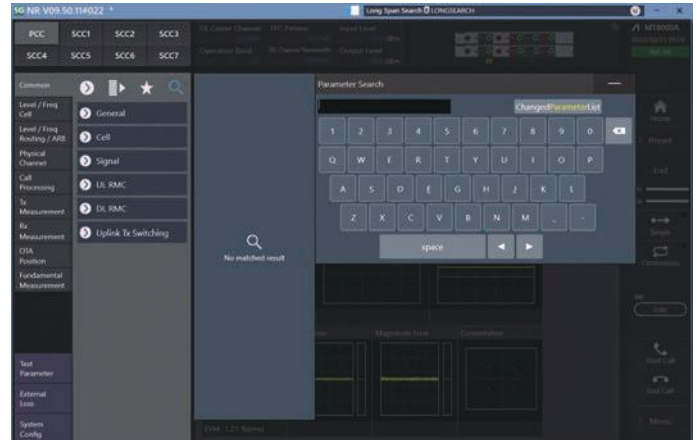

Parameter Search Function

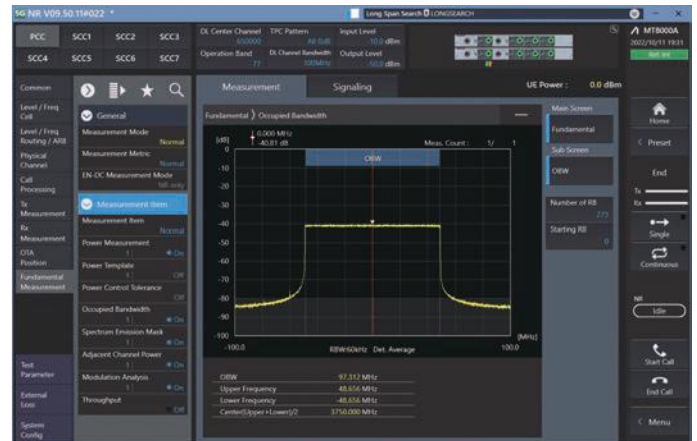

Graph Display

Radio Communication Test Station MT8000A Features

RF TRX Measurement GUI : MX800010A

OTA (Over The Air) Tests

OTA evaluation is required because the TRx performance of mobile terminals is influenced by factors such as the terminal form and antenna characteristics, etc.

There are two main types of 5G NR OTA test as follows:

- mmWave RF TRx Test
- Evaluating Mobile Terminal General TRx Performance Including Antenna

<mmWave RF TRx Test>

Since 5G NR uses an antenna array for sending and receiving signals in the mmWave band, evaluation of the RF TRx performance is performed using an OTA connection without an RF cable connection like that for LTE. Anritsu provides a turnkey mmWave RF TRx measurement solution including the RF chamber.

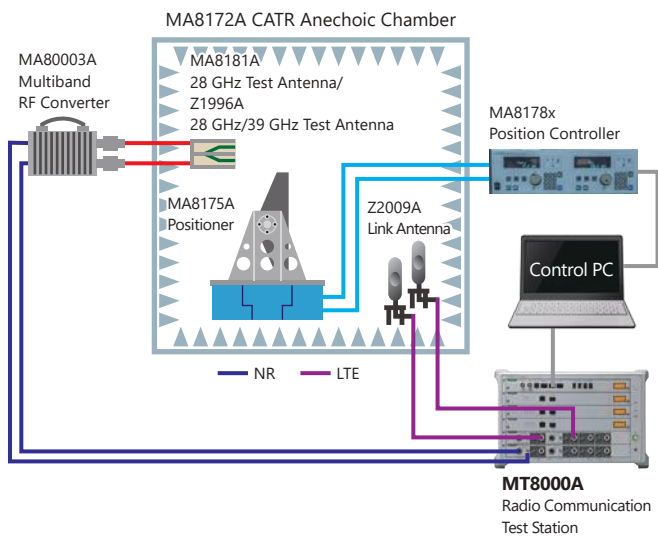

Can be constructed by combining MT8000A and MT8821C.
mmWave RF TRx Measurement Environment

<Evaluating Mobile Terminal General TRx Performance Including Antenna>

There are two antenna test methods: Total Radiated Power (TRP), and Total Radiated Sensitivity (TRS); various test systems using the MT8000A are available from OTA vendors.

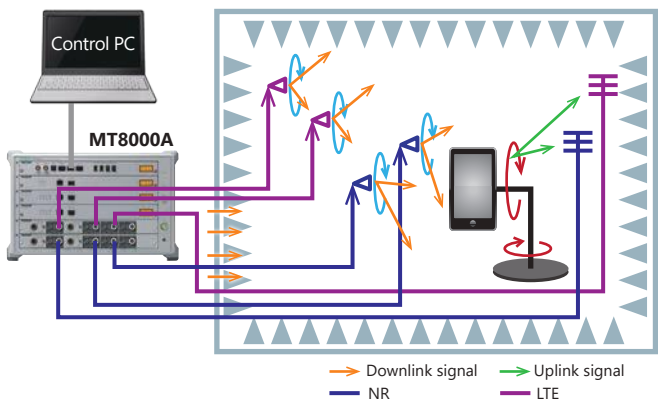

Can be constructed by combining MT8000A and MT8821C.
Radiowave Anechoic Chamber

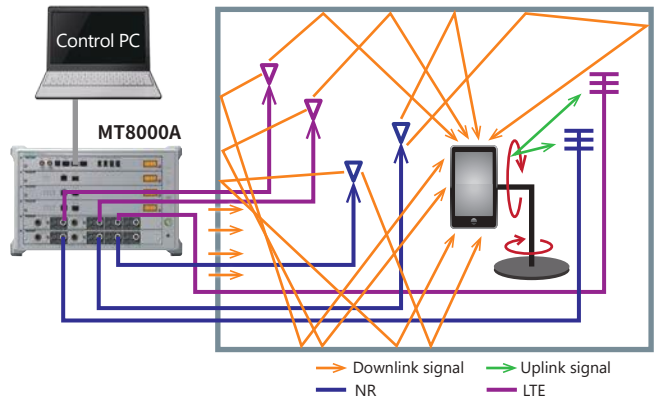

Can be constructed by combining MT8000A and MT8821C.
Reverberation Chamber

SAR (Specific Absorption Rate) Test

The SAR test evaluates the amount of energy in the electromagnetic spectrum radiated from the mobile terminal absorbed by a jig known as a 'phantom', mimicking the human body. The purpose of this test is to help protect handheld users from adverse effects of electromagnetic waves on health. The specified amount of permissible absorbed energy is regulated by national and regional standards. The MT8000A fully supports 5G NR SAR tests.

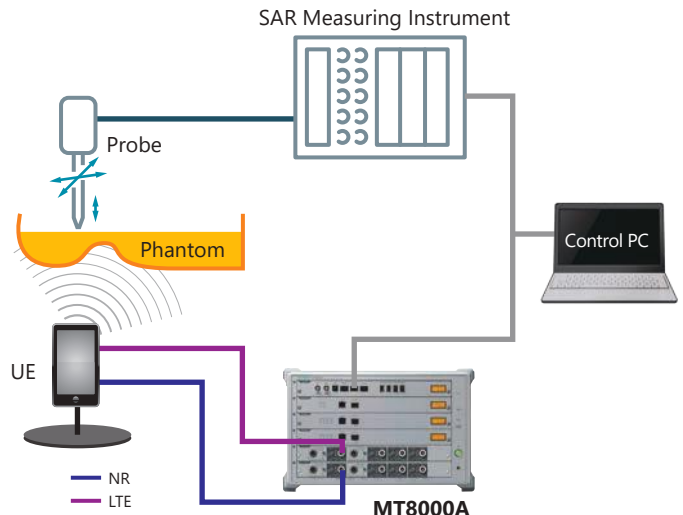

Can be constructed by combining MT8000A and MT8821C.
SAR Test Configuration

Radio Communication Test Station MT8000A Features

NR Protocol Test Solutions

Encoding/Decoding Test

The 5G NR terminal encoding/decoding test is performed by connecting the equipment as follows using an RF cable.

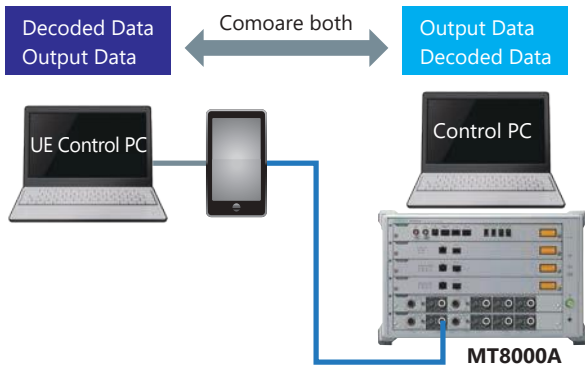

Encoding/Decoding Test Configuration (RF, Serial Control Test)

The Rapid Test Designer Platform (RTD) MX800050A and the NR Protocol Firmware MX800051A have built-in support for the digital baseband input/output function. Using the function supports high-reproducibility encoding/decoding tests without dependence on the performance of the RF section for stable baseband evaluation of 5G NR chipsets. In addition, 5G NR encoding/decoding tests are performed certainly because the baseband chip is evaluated at a slow clock below the clock frequency.

Cuts Test Case Developer Training

With a full range of test procedures for Layer 1/2 and Layer 3 tests, the RTD software eliminates the need for specialist knowledge about TTCN code and unique simulator APIs, etc. Moreover, each procedure automatically sets the Layer 1/2 (L1/L2) connection conditions based on the complex 3GPP standards. Since the MD8430A can be controlled directly, 5G NR and LTE NSA test environments can be configured easily. Furthermore, the full range of available reference test samples with confirmed connections supports development of test cases using a library.

Shortens Test Case Development Time

The RTD GUI makes it easy to create test cases using intuitive operations to connect procedures. Additionally, each procedure has a screen for setting various parameters, such as network conditions and message information, to increase test case variations using simple operation. Lastly, an analysis function checks for program mistakes prior to testing, and any code edits or changes are reflected immediately in the executed test.

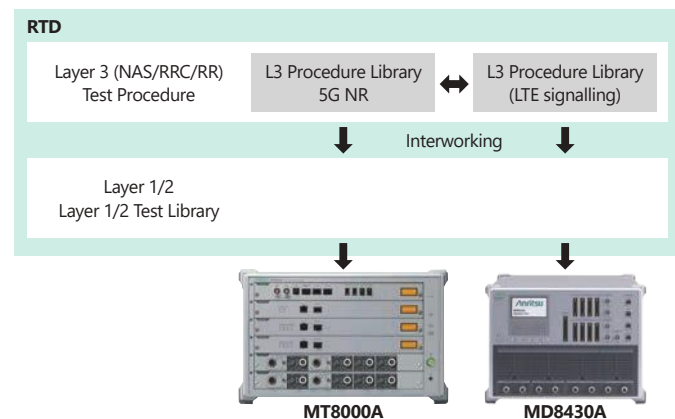

RTD Procedure Block

Efficient Execution, Evaluation and Analysis

Test sequences can be confirmed in real-time during test execution and completed test results can be confirmed at a glance because Pass/Fail evaluations are defined within the test case. Moreover, detailed analysis is supported by integration of an HTML-based protocol analyzer with the RTD. Additionally, export of logs into HTML enables logs to be opened on any PC in the same manner as the protocol analyzer.

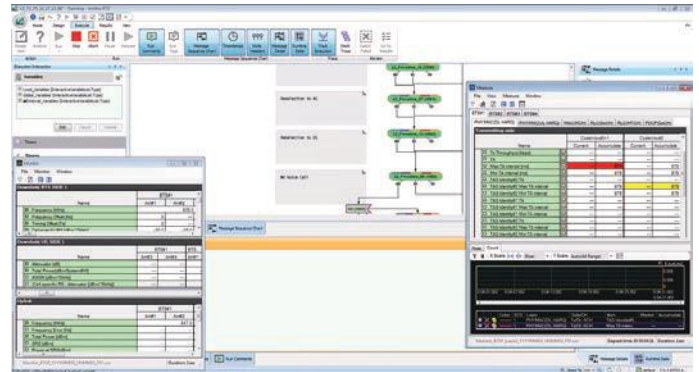

Test Execution Screen (RTD)



Log Analysis Screen (RTD)

Radio Communication Test Station MT8000A Features

NR Protocol Test Solutions

Throughput Tests at Various Conditions

Combining the MX800030A with the Data Test Module MT8000A-012 supports IP throughput tests. Sample scenarios bundled with the software can be used to change parameters, such as bandwidth, scheduling, HARQ, etc., easily for running 5G NR IP throughput tests under various conditions.

Handover Tests at Various Conditions

With support for up to 8 cells, handover tests between 5G NR 4CA cells are possible using only one MT8000A. Moreover, installing the Multi Box Data Connection MT8000A-009 option in the MT8000A enables up to 8CA 2x2 MIMO handover tests by connecting two MT8000A units. Lastly, combined use with the Signalling Tester MD8430A supports LTE interworking, helping maximize customers' investment in their existing hardware.

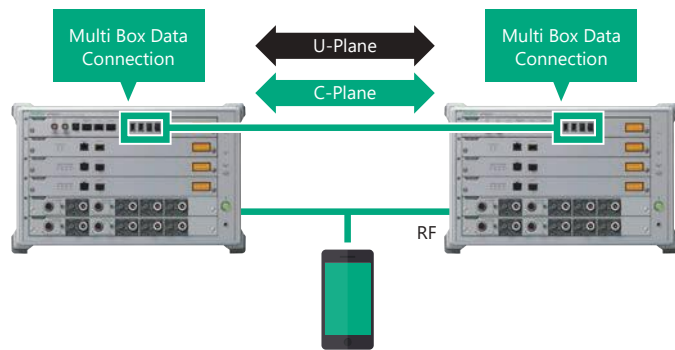

Fully Versatile L1/L2 Monitoring Functions

To support the development of 5G terminals that process large volumes of low-layer data at very high speeds, the software enhances a full line of versatile power monitoring, throughput monitoring and log analysis functions. The Measure (Counter) functions can monitor Layer 1/2 (L1/L2) throughputs in real time by counting parameter values such as ACK/NACK/DTX/CQI.

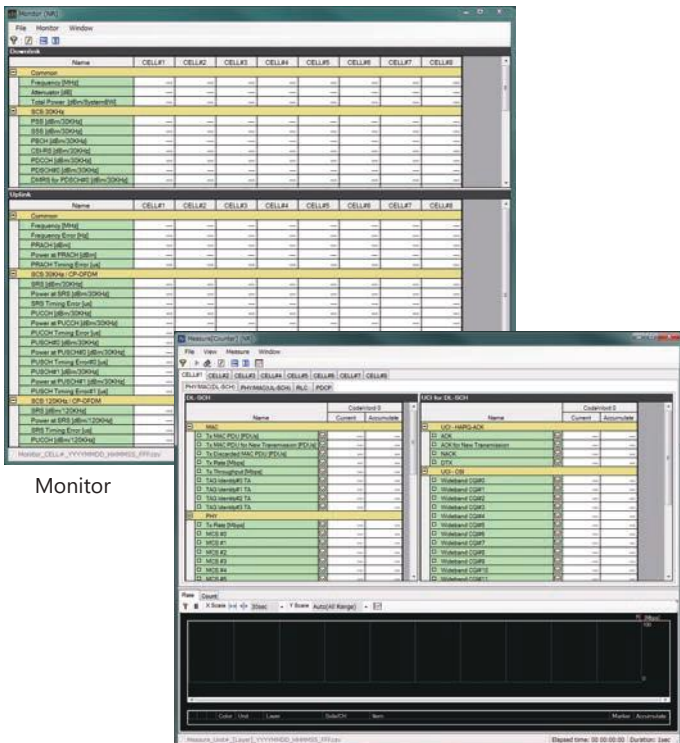

Monitor
Measure (Counter, Throughput Monitor)

Powerful Test Automation

With support for mobile terminal control interfaces, the RTD software simplifies test automation. In addition, continuous multiple test case execution and automatic test report creation as well as various functions including repeat operation for a set number of times provide powerful support for automated testing.

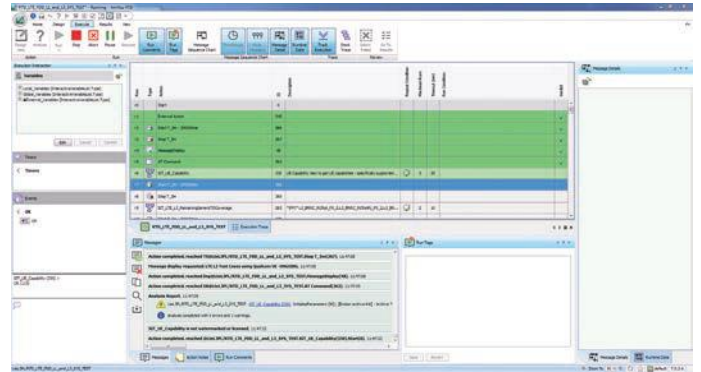

Example of Continuous Test Case Execution

Easy Test Case Maintenance

Test cases created using the RTD software are easily updated for new 3GPP standard releases, helping cut test-case editing workloads. Moreover, recompiling is unnecessary because test cases maintain compatibility even after firmware updates. Consequently, test-case maintenance costs at commercial release of new mobile terminals are greatly reduced for pre-inspection regression tests and interoperability tests (IOT) with networking equipment.

5G NR/4G LTE Fading Tests

In cooperation with a fading PC, one MT8000A supports NR downlink fading tests up to 4CA 2x2 MIMO or 2CA 4x4 MIMO. Using two MT8000A units extends NR fading test support up to 8CA 2x2 MIMO or 4CA 4x4 MIMO. Furthermore, by adding one MT8000A for LTE BTS, it also supports the EN-DC fading test up to LTE 6CA 8x4 MIMO*. The fading software includes 3GPP channel models which are compliant with TS38.521 for 5G NR (TDL), TS36.521 for 4G LTE. The channel models can be edited as necessary.

*: Requires additional PC for LTE fading.

Radio Communication Test Station MT8000A Features

Application and Regression Tests for 5G devices: SmartStudio NR MX800070A

5G Device Application Tests

With an interactive GUI, SmartStudio NR MX800070A supports FR1/FR2 UE call connections, IP throughput tests, and IMS VoLTE testing, as well as Internet connections, live server application tests, and various mobility tests without requiring difficult scenario development. Moreover, user-generated test cases can be executed automatically using the SmartStudio Manager external control tool or an external control interface.

Interactive GUI

The easy-to-use interactive GUI requires no knowledge of high-level protocols, and the current UE real-time status is displayed on the UE Status screen along with detailed protocol messages and sequences under the Log Display screen. Additionally, PDN settings, creation of test cases, etc., are supported.

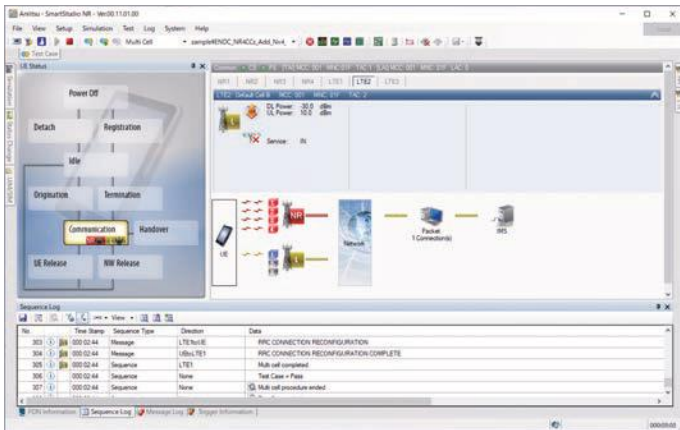

SmartStudio NR Main Screen

Easy UE Capability Confirmation

UE Capability data are managed automatically and displayed at the UE Capability Information screen for easy confirmation during testing of UE-supported patterns, etc., of combinations of categories, bands, and CAs.

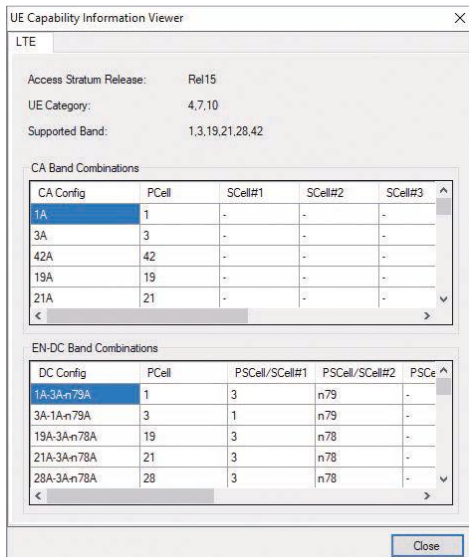

Test Environment and Base Station Settings

The number of base stations in use, RAT, and antennas are set at the Simulation Parameter screen. In addition, an RF cable setup diagram based on set parameters is displayed, providing strong support for configuring the user's test environment. SIM and other user parameters are also set easily.



Simulation Parameter Settings Screen

Detailed parameters for each base station in use can be set at the Cell Parameter screen, where settings such as the band, frequency, bandwidth, UL/DL power, QAM, MCS, etc., can be set, saved, and loaded.

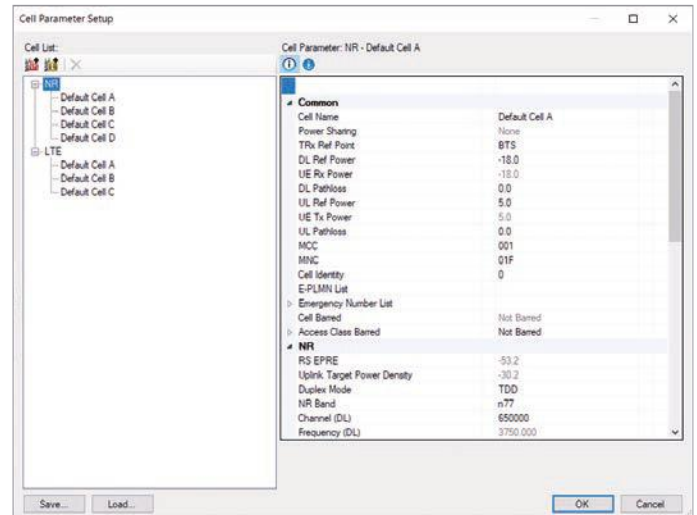

Cell Parameter Settings Screen

The base station TRx power can be changed during the simulation. In addition, base station transmissions can be stopped when executing the out of signal area test, and power can be controlled from the Test Case screen.

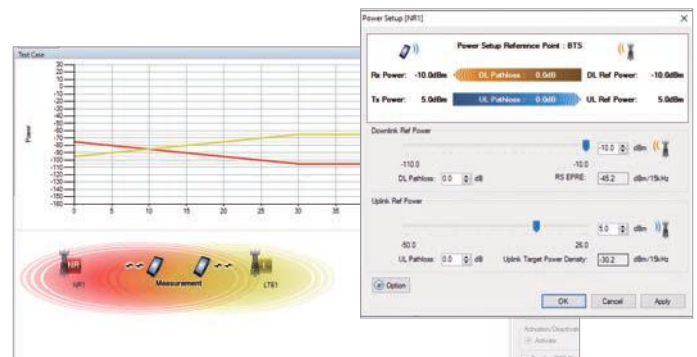

Radio Communication Test Station MT8000A Features

Application and Regression Tests for 5G devices: SmartStudio NR MX800070A

Built-in IMS/PWS Service

With built-in IMS/PWS Service, the SmartStudio NR MX800070A supports VoLTE and SMS tests without requiring users to configure complex environments. Moreover, PWS Service tests, such as ETWS and CMAS, which are difficult to execute on a live network, are implemented easily, and message contents can also be edited.

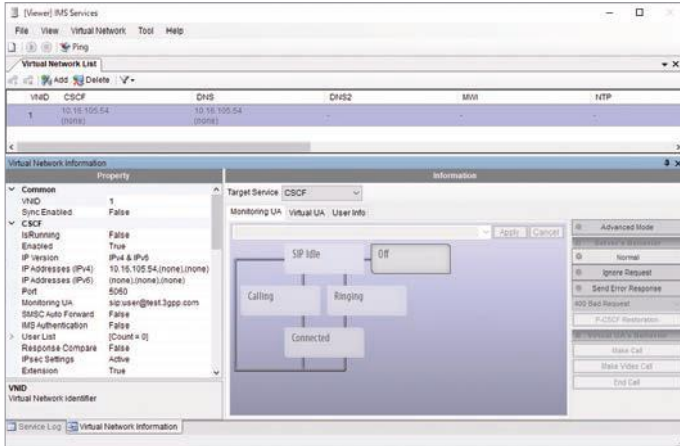

IMS Service Settings Screen

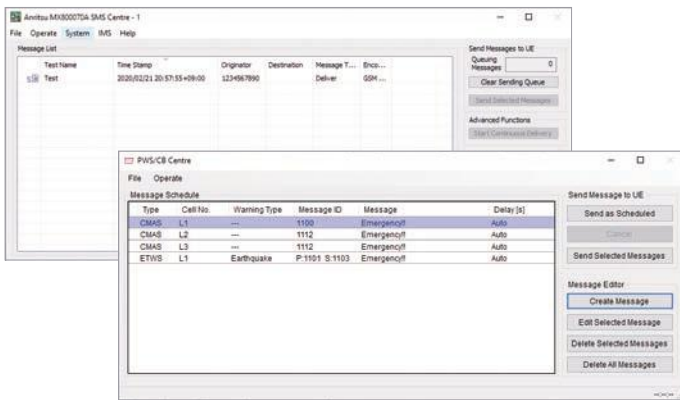

SMS/PWS Service Screen

Test Automation

Studio NR and the UE can be controlled externally using SmartStudio Manager to configure an automated general test system. In addition to bundled test cases, users can create their own test cases with easy Pass/Fail confirmation after execution.

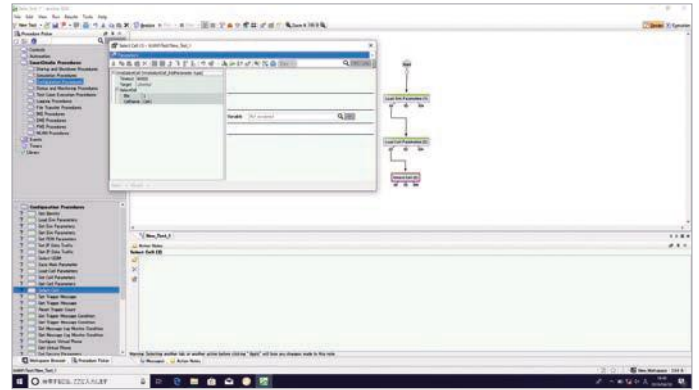

SmartStudio Manager Test Case Creation Screen

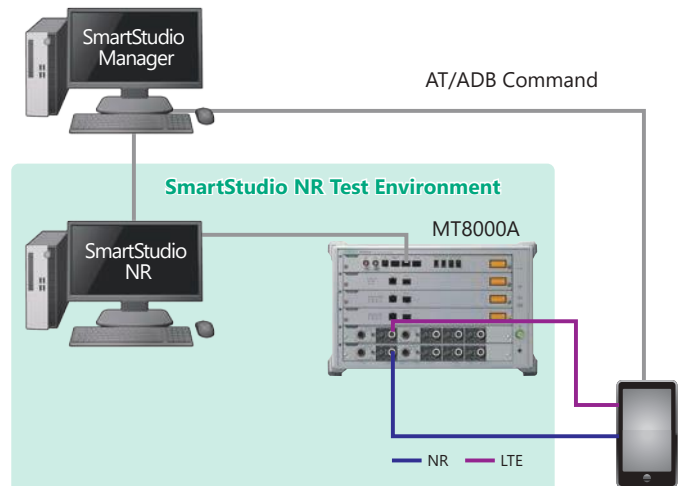

Can be constructed by combining MT8000A and MD8475B.

SmartStudio Manager Test Environment Example

Radio Communication Test Station MT8000A Features

Application and Regression Tests for 5G devices: SmartStudio NR MX800070A

- Evaluating Automobile Module Wireless Communications Ability:
SSM Test PKG Telematics Connectivity MX847503A-TL660
SSM Test PKG Telematics Throughput MX847503A-TL661
SSM Test PKG Telematics Mobility Basic MX847503A-TL662

The MX847503A-TL660/TL661/TL662 generates test patterns to analyze the wireless communications ability notified by the vehicle module and executes the test sequence.

The operation GUI displays the test sequence, sets the notification conditions, starts/stops the simulation, and automatically controls the test, including acquisition of measurement logs.

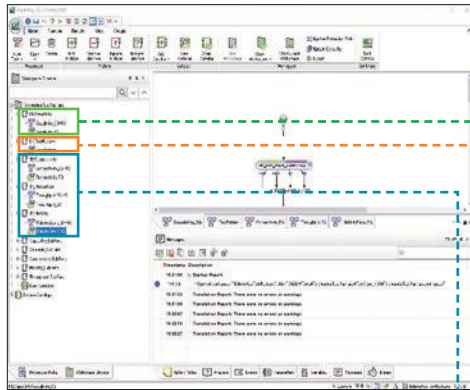

Provides evaluation procedure as test sequence

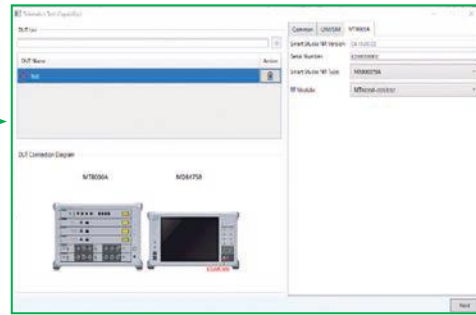

Step 1 Acquires vehicle module wireless communications ability

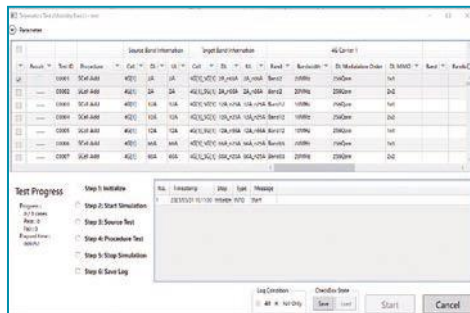

Step 3 Executes test (Connectivity/Throughput/Mobility)

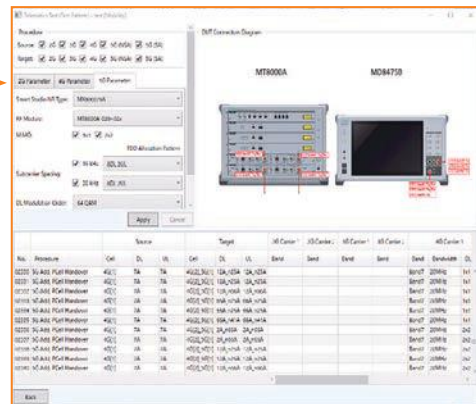

Step 2 Generates test pattern

Radio Communication Test Station MT8000A Features

Higher IP Data Throughput Test for 5G devices: SmartStudio NR IP Performance MX800071A

More Efficient 5G Device IP Data Throughput Tests

The SmartStudio NR IP Performance MX800071A software solution supports easy and intuitive IP data throughput tests of 5G devices under a wide variety and increasing range of 5G band, CA, and MIMO combinations. Additionally, the MT8000A platform covering tests for each 4G/5G, NSA/SA wireless communication system simplifies conventional complex test environments using multiple platforms.

Cell Parameter (CA, MIMO, TDD configuration, etc.)

TDD Configuration Setup - Manual/Dedicated

DL/UL Periodicity	Pattern	Pattern
Slot	0	1 2 3 4 5 6 7 8 9 10 11 12 13 14 15 16 17 18 19 20
DL/UL Allocation	0 1 0 0 0 0 0 0 0 0 0 0 0 0 0 0 0 0 0 0	0 0 0 0 0 0 0 0 0 0 0 0 0 0 0 0 0 0 0 0
Number of DL Symbols	14	14 14 14 14 14 14 14 14 14 14 14 14 14 14 14 14 14 14 14 14
Number of UL Symbols	0	0 0 0 0 0 0 0 0 0 0 0 0 0 0 0 0 0 0 0 0
PDSCH		
K1	+6	+5 +4 +3 +2 +1 +0 -1 -2 -3 -4 -5 -6 -7 -8 -9 -10 -11 -12 -13 -14 -15 -16 -17 -18 -19 -20
Symbols	13	13 13 13 13 13 13 13 13 13 13 13 13 13 13 13 13 13 13 13 13
PUSCH #1		
K2	-	-
Symbols	-	-
PUSCH #2		
K2	-	-
Symbols	-	-

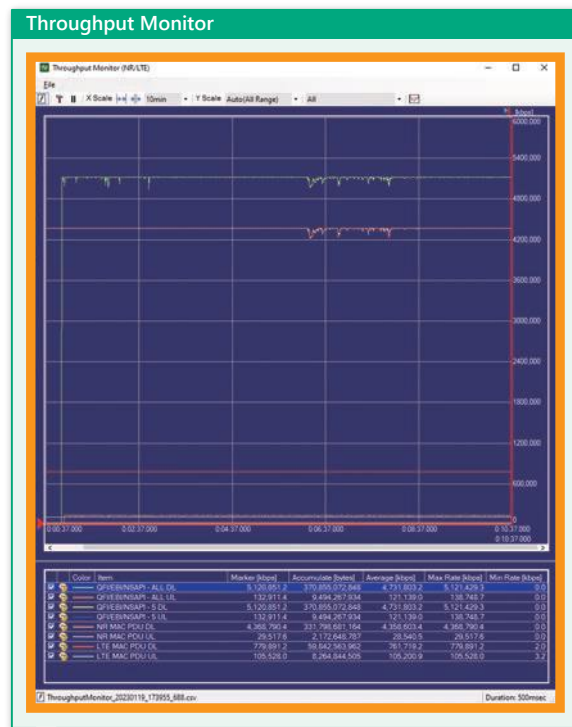

Simulation Parameter (Frequency, Channel, BW, etc.)

Simulation Parameter Setup

Machine Config: MT8000A v-LTE

RF Sub-Module: RF Sub-Module

Simulation Model: NR LTE

SmartStudio NR IP Performance Measurement Screen

UE Status

Sequence Log between UE and MT8000A

No.	Process	TL	BTS	Deviation	Message
28	00:00:18:028	881	NR		EMM IDENTITY RESPONSE
29	00:00:18:196	881	NR		UE CAPABILITY ENQUIRY
30	00:00:18:583	881	NR		UE CAPABILITY INFORMATION
31	00:00:19:510	881	NR		NR CONNECTION RECONFIGURATION
32	00:00:19:545	881	NR		NR CONNECTION RECONFIGURATION COMPLETE
33	00:00:19:545	881	NR		EMM ATTACH COMPLETE; EMM ACTIVATE DEFAULT EPS BEARER CONTEXT ACCEPT
34	00:00:19:601	881	NR		EMM EMM INFORMATION
35	00:00:23:386	881	NR		NR CONNECTION RECONFIGURATION
36	00:00:24:316	881	NR		NR CONNECTION RECONFIGURATION COMPLETE
37	00:00:25:711	881	NR		NR CONNECTION RECONFIGURATION
38	00:00:25:752	881	NR		NR CONNECTION RECONFIGURATION COMPLETE

Radio Communication Test Station MT8000A Optional Accessories

Butler Matrix 8x8: MA8118A / Butler Matrix 4x4: MA8114A

Efficient IP/PHY Throughput Tests by Reducing RF Cable Changes During Testing

The 100+ 5G SA/NSA band combination patterns resulting from higher-order Carrier Aggregation and extended FR1 frequency range require an efficient test method.

The MA8118A/MA8114A supports MIMO tests that are not supported by RF combiner combinations.

Consequently, the MA8118A supports efficient IP/PHY throughput tests when evaluating 5G devices by minimizing RF cable changes during testing.

The MA8118A is a Butler Matrix module with 8 input ports × 8 output ports; the MA8114A is a Butler Matrix module with 4 input ports × 4 output ports.

Direct RF Cable Link:

- Needs re-cabling many times to test all UE band combinations

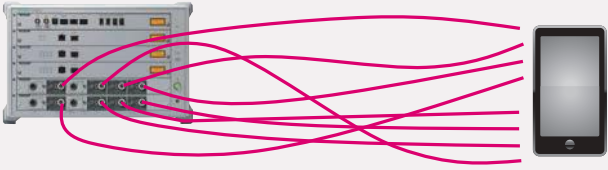

☹️

RF Combiner Combinations:

- No support for MIMO tests because RF combiners mix all signals

Cannot use RF Combiner Combinations

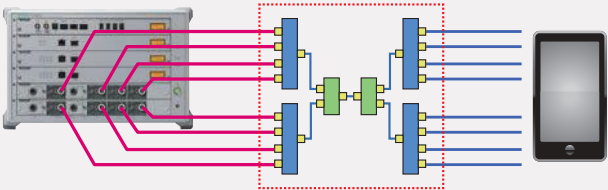

☹️

Butler Matrix (MA8118A/MA8114A):

- Needs only minimum re-cabling to test all UE band combinations
- Supports MIMO testing because MA8118A/MA8114A divides all signals
- Supports Base Station/Wi-Fi AP MIMO tests

Easy MIMO Transmission Path Configuration

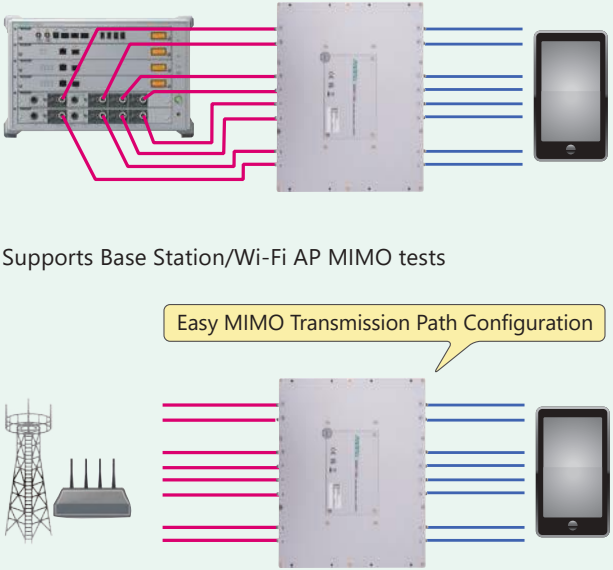

😊

Radio Communication Test Station MT8000A Layout

MT8000A Front Panel



- 1 Ground Terminal**
Functional ground terminal used as a measure against electrostatic discharge while using the MT8000A.
- 2 Power Switch**
Switches power-on and standby. When the MT8000A is in the power on status, the LED lights up (green).
- 3 Standby LED**
When the MT8000A is in the standby status of which the AC power is on, the LED lights (orange).
- 4 Recover LED/Recover Switch**
Switch to recover MT8000A in case of emergency. Recovery LED lights up (orange) when the recovery function is enabled.
- 5 Caution LED**
Lights up (orange) when MT8000A detects abnormality.
- 6 Ready LED**
Lights up (green) when MT8000A startup is completed after power-on.
- 7 Control Module MT8000A-001 (with Multi-box Data Connection MT8000A-009)**
Controls the entire MT8000A, processes upper layers, downloads firmware, and start MT8000A. Optical ports are used for connecting multiple MT8000As.
- 8 Data Test Module MT8000A-012**
Performs data transfer for IP throughput test.
- 9 Baseband Module MT8000A-011**
Performs baseband processing (L1/L2) in protocol test.
- 10 RF Base Module MT8000A-033**
Converts digital signals into analog signals.
Functions as RF interface for the external RF Converter or for RF signals in 2 GHz to 7.125 GHz.

Radio Communication Test Station MT8000A Layout

MT8000A Modules

Control Module MT8000A-001

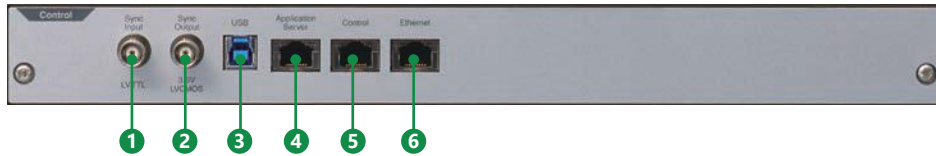

Control Module MT8000A-001 + Multi-box Data Connection MT8000A-009

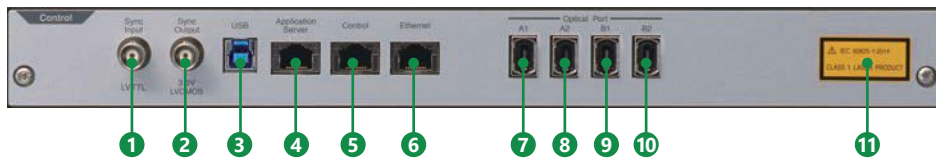

- 1 Sync Input Connector**
BNC connector for inputting synchronizing signal.
- 2 Sync Output Connector**
BNC connector for outputting synchronizing signal.
- 3 USB Connector**
USB (Type B) connector to connect the external PC.
- 4 Application Server Connector**
RJ-45 connector to connect the external PC for Application Server.
- 5 Control Connector**
RJ-45 connector for connecting the MT8000A and Control PC.
- 6 Ethernet Connector**
RJ-45 connector for connecting the external PC, etc.
- 7 Optical Port A1 Connector**
MPO connector A1 for connecting multiple MT8000As when MT8000A-009 Multi-box Data Connection is installed.
- 8 Optical Port A2 Connector**
MPO connector A2 for connecting multiple MT8000As when MT8000A-009 Multi-box Data Connection is installed.
- 9 Optical Port B1 Connector**
MPO connector B1 for connecting multiple MT8000As when MT8000A-009 Multi-box Data Connection is installed.
- 10 Optical Port B2 Connector**
MPO connector B2 for connecting multiple MT8000As when MT8000A-009 Multi-box Data Connection is installed.
- 11 Explanatory Label**
Indicates that the Optical Port A1, A2, B1, and B2 are Class 1 laser products.

Radio Communication Test Station MT8000A Layout

MT8000A Modules

Data Test Module MT8000A-012



- 1 Data Test Status LED**
Indicates the Data Test status.
- 2 Ethernet Connector for Data Test**
RJ-45 connector for Data Test.
- 3 SFP/SFP+ Connector**
Connector to insert SFP or SFP+ (application parts) into.
- 4 Explanatory Label**
Indicates that the device is a Class 1 laser product when SFP or SFP+ are installed.

Baseband Module MT8000A-011



- 1 Baseband Status LED**
Indicates the Baseband status.
- 2 Ethernet Connector for Baseband**
RJ-45 connector for Baseband.
- 3 SFP/SFP+ Connector**
Connector to insert SFP or SFP+ (application parts) into.
- 4 Explanatory Label**
Indicates that the device is a Class 1 laser product when SFP or SFP+ are installed.

Radio Communication Test Station MT8000A Layout

MT8000A Modules

RF Base MT8000A-020

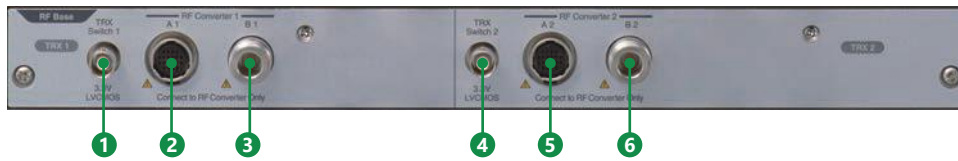

MT8000A-020 + 3 GHz-12 GHz RF Sub Module MT8000A-022

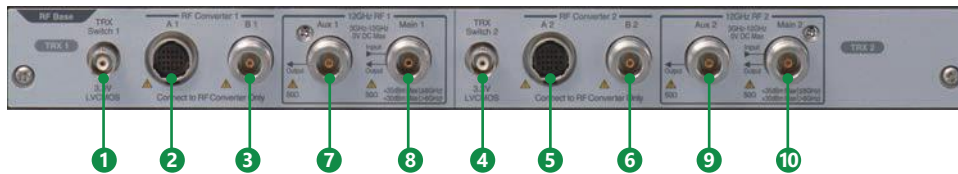

MT8000A-020 + MT8000A-022 + Extend RF 2.4 GHz-3 GHz MT8000A-023

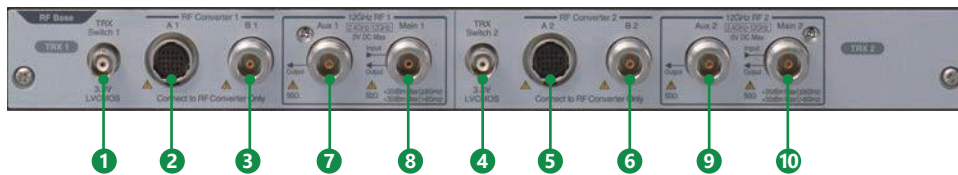

- 1 TRX Switch 1 Connector**
BNC connector that outputs signals to control the external amplifier, etc.
- 2 RF Converter 1 A1 Connector**
Multi-contact connector that controls the external RF Converter.
- 3 RF Converter 1 B1 Connector**
N connector that input/output the external RF Converter and RF signals.
- 4 TRX Switch 2 Connector**
BNC connector that outputs signals to control the external amplifier, etc.
- 5 RF Converter 2 A2 Connector**
Multi-contact connector that controls the external RF Converter.
- 6 RF Converter 2 B2 Connector**
N connector that inputs/outputs the RF signals between the external RF Converter and MT8000A.
- 7 12 GHz RF1 Aux 1 Connector**
RF auxiliary connector (output) when 3 GHz-12 GHz RF Sub Module option is installed.
- 8 12 GHz RF1 Main 1 Connector**
RF main connector (input/output) when 3 GHz-12 GHz RF Sub Module option is installed.
- 9 12 GHz RF2 Aux 2 Connector**
RF auxiliary connector (output) when 3 GHz-12 GHz RF Sub Module option is installed.
- 10 12 GHz RF2 Main 2 Connector**
RF main connector (input/output) when 3 GHz-12 GHz RF Sub Module option is installed.

Note: The frequency range indicated on the panel is "2.4 GHz-12 GHz" when MT8000A-023 Extend RF 2.4 GHz-3 GHz is installed. RF Converter 1 and RF Converter 2 cannot be used simultaneously with 12 GHz RF 1 and 12 GHz RF 2 respectively.

Radio Communication Test Station MT8000A Layout

MT8000A Modules

RF Base Module MT8000A-020 + 0.4 GHz-6 GHz RF Sub Module MT8000A-021

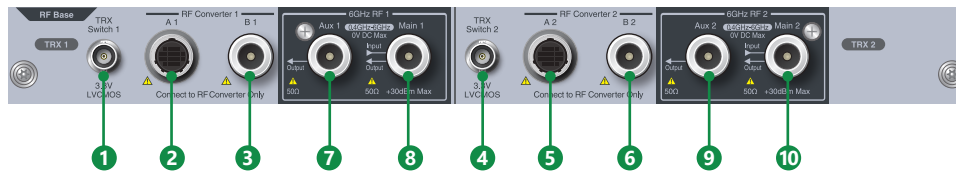

- 1 TRX Switch 1 connector**
BNC connector that outputs signals to control the external amplifier, etc.
- 2 RF Converter 1 A1 connector**
Multi-contact connector that controls the external RF Converter.
- 3 RF Converter 1 B1 connector**
N connector that input/output the external RF Converter and RF signals.
- 4 TRX Switch 2 connector**
BNC connector that outputs signals to control the external amplifier, etc.
- 5 RF Converter 2 A2 connector**
Multi-contact connector that controls the external RF Converter.
- 6 RF Converter 2 B2 connector**
N connector that inputs/outputs the RF signals between the external RF Converter and MT8000A.
- 7 6 GHz RF1 Aux 1 connector**
RF auxiliary connector (output) when 0.4 GHz-6 GHz RF Sub Module option is installed.
- 8 6 GHz RF1 Main 1 connector**
RF main connector (input/output) when 0.4 GHz-6 GHz RF Sub Module option is installed.
- 9 6 GHz RF2 Aux 2 connector**
RF auxiliary connector (output) when 0.4 GHz-6 GHz RF Sub Module option is installed.
- 10 6 GHz RF2 Main 2 connector**
RF main connector (input/output) when 0.4 GHz-6 GHz RF Sub Module option is installed.

Note: The frequency range indicated on the panel is "0.4 GHz-6 GHz" when 0.4 GHz-6 GHz RF Sub Module MT8000A-021 is installed. RF Converter 1 and RF Converter 2 cannot be used simultaneously with 6 GHz RF 1 and 6 GHz RF 2 respectively.

Radio Communication Test Station MT8000A Layout

MT8000A Modules

Multi RF Module MT8000A-031/Multi RF Extension MT8000A-032

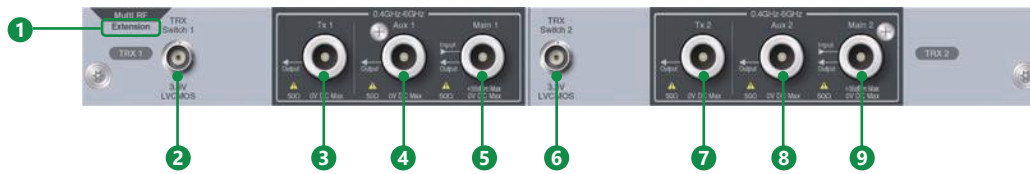

- 1 Extension marking**
Mark for Multi RF Extension MT8000A-032. No mark for Multi RF Module MT8000A-031.
- 2 TRX Switch 1 connector**
BNC connector that outputs signals to control the external amplifier, etc.
- 3 Tx 1 connector**
RF transmission connector (output) for 0.4 GHz-6 GHz signal.
- 4 Aux 1 connector**
RF auxiliary connector (output) for 0.4 GHz-6 GHz signal.
- 5 Main 1 connector**
RF main connector (input/output) for 0.4 GHz-6 GHz signal.
- 6 TRX Switch 2 connector**
BNC connector that outputs signals to control the external amplifier, etc.
- 7 Tx 2 connector**
RF transmission connector (output) for 0.4 GHz-6 GHz signal.
- 8 Aux 2 connector**
RF auxiliary connector (output) for 0.4 GHz-6 GHz signal.
- 9 Main 2 connector**
RF main connector (input/output) for 0.4 GHz-6 GHz signal.

Radio Communication Test Station MT8000A Layout

MT8000A Modules

0.4 GHz-7.125 GHz Enhanced RF Module MT8000A-033

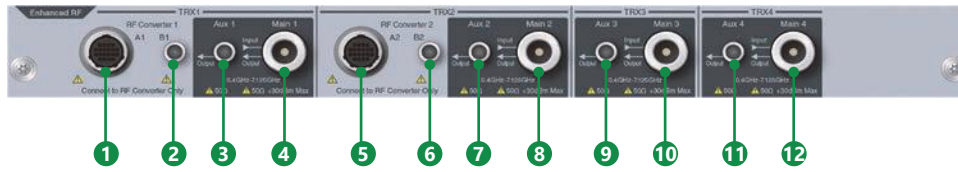

- 1 RF Converter 1 A1 connector**
Multi-contact connector that controls the external RF Converter.
- 2 RF Converter 1 B1 connector**
SMA connector that input/output the external RF Converter and RF signals.
- 3 Aux 1 connector**
RF auxiliary connector (output) for 0.4 GHz-7.125 GHz signal.
- 4 Main 1 connector**
RF main connector (input/output) for 0.4 GHz-7.125 GHz signal.
- 5 RF Converter 2 A2 connector**
Multi-contact connector that controls the external RF Converter.
- 6 RF Converter 2 B2 connector**
SMA connector that input/output the external RF Converter and RF signals.
- 7 Aux 2 connector**
RF auxiliary connector (output) for 0.4 GHz-7.125 GHz signal.
- 8 Main 2 connector**
RF main connector (input/output) for 0.4 GHz-7.125 GHz signal.
- 9 Aux 3 connector**
RF auxiliary connector (output) for 0.4 GHz-7.125 GHz signal.
- 10 Main 3 connector**
RF main connector (input/output) for 0.4 GHz-7.125 GHz signal.
- 11 Aux 4 connector**
RF auxiliary connector (output) for 0.4 GHz-7.125 GHz signal.
- 12 Main 4 connector**
RF main connector (input/output) for 0.4 GHz-7.125 GHz signal.

Radio Communication Test Station MT8000A Layout

MT8000A Rear Panel

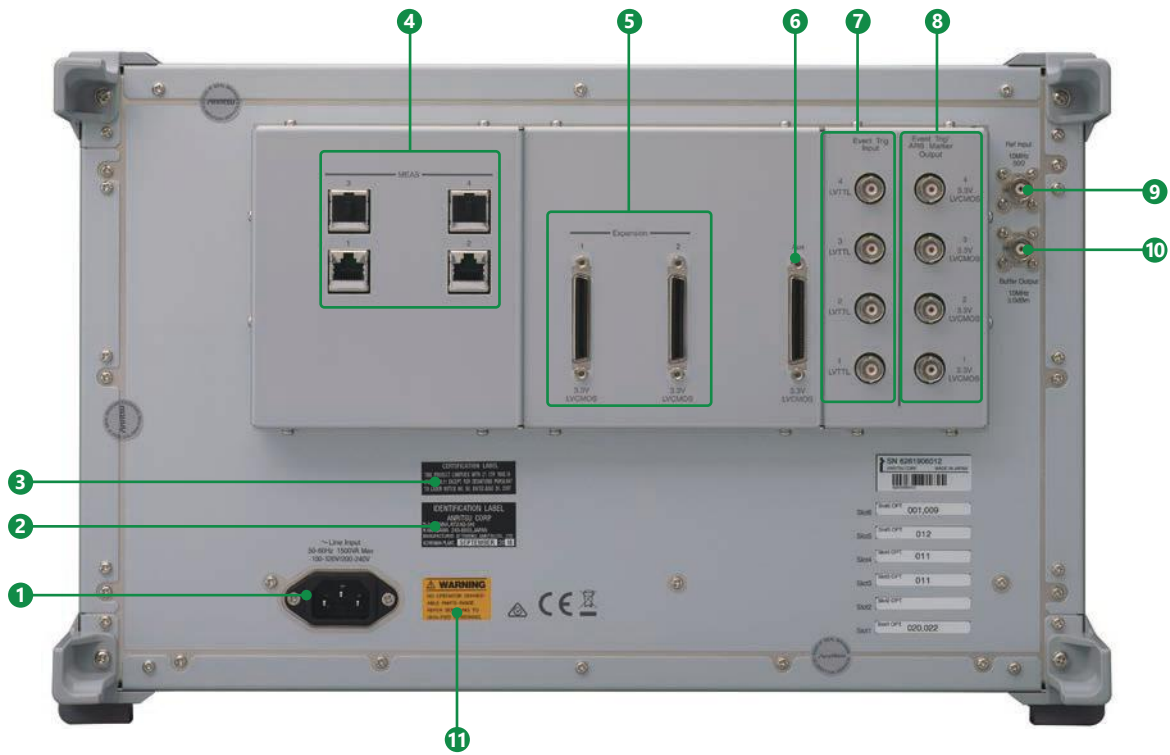

- 1 Power Inlet**
Power cable connector for 100 VAC to 120 VAC or 200 VAC to 240 VAC (50 Hz/60 Hz) (auto-switching).
Power consumption: 1500 VA or less.
- 2 Identification Label**
Identifies the manufacturer of laser products.
- 3 Certification Label**
Certifies that the MT8000A conforms to 21 CFR 1040.10 AND 1040.11 except in accordance with Laser Notice No.56.
- 4 Ethernet Connector for Measure**
RJ-45 connector for measurement.
- 5 Expansion Connector**
Used for input/output of trigger signals.
- 6 Aux Connector**
Auxiliary connector to output frame timing signals.
- 7 Event Trigger Input Connector**
BNC connector to input event triggers from external devices. Can input event trigger signals of 4 systems.
- 8 Event Trigger Output Connector**
BNC connector to output event triggers to external devices. Can output event trigger signals of 4 systems. Can be used also as output of ARB marker.
- 9 Reference signal input connector**
BNC connector to input 10 MHz reference signal from external devices.
- 10 Reference Signal Output Connector**
BNC connector to output 10 MHz reference signal built in the MT8000A.
- 11 Safety Label**
WARNING label for safe operation of MT8000A. Observe the description on the label.

Radio Communication Test Station MT8000A Layout

System Configuration



- 1 Radio Communication Test Station MT8000A**
All-in-one test platform supporting 5G RF measurements and protocol tests.
- 2 28 GHz RF Converter MA80001A/39 GHz RF Converter MA80002A/Multiband RF Converter MA80003A**
Convert frequency of RF signal output from MT8000A to 28 GHz and 39 GHz band.
- 3 RF Chamber MA8171A**
For 5G protocol tests in OTA environment.
For 5G RF measurement, please use MA8172A (Refer to the OTA Product Catalog for details).
- 4 Position Controller MA8174A**
Controls the Positioner MA8175A rotational angle inside the RF Chamber MA8171A.
When using MA8172A, please use MA8178x. (Refer to the OTA Product Catalog for details).

Radio Communication Test Station MT8000A Specifications

Radio Communication Test Station MT8000A

Reference Oscillator	Reference frequency: 10 MHz Start-up characteristics: $\pm 5 \times 10^{-8}$ (3 min. after power-on. Referenced to frequency 1 hour after power-on) Aging rate: $\pm 1 \times 10^{-9}$ /day (referenced to frequency 48-hour after power-on) $\pm 1 \times 10^{-7}$ /year (referenced to frequency 10-day after power-on) Temperature characteristics: $\pm 2 \times 10^{-8}$ Frequency adjusted at shipment: $\pm 2.2 \times 10^{-8}$ (+18°C to +28°C, referenced to frequency 1 hour after power-on) 10 MHz Buffer Output Frequency: 10 MHz Connector: BNC (f) Impedance: 50Ω (nom.) Output Level: ≥ 0 dBm (AC coupling) 10 MHz Ref Input Frequency: 10 MHz Operating range: ± 1 ppm Connector: BNC (f) Impedance: 50Ω (nom.) Input level: -15 dBm \leq level \leq +20 dBm (AC coupling)	
External Interface	MEAS 1 to 4: RJ45, 1000Base-T, for slot 1 to 4 Event TRIG Input 1 to 4: BNC (f), LVTTTL Event TRIG/ARB Maker Output 1 to 4: BNC (f), 3.3 V LVCMOS Expansion 1, 2: DX20A (3.3 V LVCMOS) Aux: DX20A (3.3 V LVCMOS)	
Power Supply	Rated voltage: 100 VAC to 120 VAC/200 VAC to 240 VAC (Operating voltage is $-15\%/+10\%$ of rated voltage, however, lower limit is 90 V, upper limit is 250 V) Rated frequency: 50 Hz/60 Hz Power consumption: ≤ 1500 VA (include all options and modules)	
Dimensions and Mass	Dimensions: 426 (W) \times 265 (H) \times 578 (D) mm (excluding projections) Mass: ≤ 50 kg (including all options)	
Environmental Conditions	Operating temperature range: $+5^{\circ}\text{C}$ to $+40^{\circ}\text{C}$ (without condensation) Storage temperature: -20°C to $+71^{\circ}\text{C}$ (without condensation)	
CE	EMC	2014/30/EU, EN61326-1, EN61000-3-2
	LVD	2014/35/EU, EN61010-1
	RoHS	2011/65/EU, (EU) 2015/863, EN IEC 63000: 2018
UKCA	EMC	S.I. 2016 No.1091, EN 61326-1, EN61000-3-2
	LVD	S.I. 2016 No.1101, EN 61010-1
	RoHS	S.I. 2012 No.3032, EN IEC 63000:2018
Laser Safety*	IEC 60825-1 Class 1 FDA 21CFR1040.10 and 1040.11 Excludes deviations caused by conformance to LASER Notice No.56 dated May 8, 2019	

*: Safety measures for laser products

This option complies with optical safety standards in IEC 60825-1, 21CFR1040.10 and 1040.11; the following descriptive labels are affixed to the product.

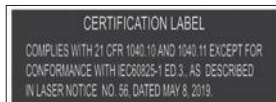

Control Module MT8000A-001

External Interface	USB: USB (Type-B) Application Server: RJ-45 (1000Base-T) Control: RJ-45 (1000Base-T) Ethernet: RJ-45 (1000Base-T) Sync Input: BNC (f) (LVTTTL) Sync Output: BNC (f) (3.3 V LVCMOS)
--------------------	---------------------------------------------------------------------------------------------------------------------------------------------------------------------------------------------------

Multi-box Data Connection MT8000A-009

External Interface	Optical Port A1, A2, B1, B2: MPO optical adapter (m), 24 cores
--------------------	----------------------------------------------------------------

Typical (typ.): Performance not warranted.

Must products meet typical performance.

Nominal (nom.): Values not warranted.

Included to facilitate application of product.

Radio Communication Test Station MT8000A Specifications

Baseband Module MT8000A-011

External Interface	Ethernet: RJ-45 (1000Base-T) SFP/SFP+: SFF-8431, SFF-8472 compliant IEEE 802.3ae-2002, IEEE 802.3-2008 compliant
--------------------	------------------------------------------------------------------------------------------------------------------------

Data Test Module MT8000A-012

External Interface	Ethernet: RJ-45, 1000Base-T SFP/SFP+: SFF-8431, SFF-8472 compliant IEEE 802.3ae-2002, IEEE 802.3-2008 compliant
--------------------	-----------------------------------------------------------------------------------------------------------------------

RF Base Module MT8000A-020

IF Input/Output Connector	RF Converter B1, B2 Connector: N (f) Impedance: 50Ω (nom.)
External Interface	RF Converter A1, A2: Round multiway type connector TRX Switch 1, 2: BNC (f) (3.3 V LVCMOS)

0.4 GHz-6 GHz RF Sub Module MT8000A-021

General	<p>RF input/output connector Main 1, Main 2 Connector: N (f) Impedance: 50Ω (nom.) VSWR At 0.4 GHz ≤ setting frequency < 3 GHz ≤1.5 (0.4 GHz ≤ frequency < 3.1 GHz) At 3 GHz ≤ setting frequency ≤ 6 GHz ≤1.5 (2.9 GHz ≤ frequency ≤ 6.1 GHz)</p> <p>RF output connector Aux 1, Aux 2 Connector: N (f) Impedance: 50Ω (nom.) VSWR At 0.4 GHz ≤ setting frequency < 3 GHz ≤1.6 (0.4 GHz ≤ frequency < 3.1 GHz) At 3 GHz ≤ setting frequency ≤ 4.2 GHz ≤1.9 (2.9 GHz ≤ frequency ≤ 4.3 GHz) At 4.2 GHz < setting frequency ≤ 6 GHz ≤2.0 (4.1 GHz < frequency ≤ 6.1 GHz)</p>
---------	---------------------------------------------------------------------------------------------------------------------------------------------------------------------------------------------------------------------------------------------------------------------------------------------------------------------------------------------------------------------------------------------------------------------------------------------------------------------------------------------------------------------------------------------------------------------------------------------------------------------------------------------------------------------

Radio Communication Test Station MT8000A Specifications

Transmission Characteristics	<p>Frequency Setting range: 0.4 GHz to 6 GHz Setting resolution: 1 Hz Accuracy: Depend on accuracy of reference oscillator</p> <p>Level Setting range Main 1, Main 2 -110 to -10 dBm (0.4 GHz ≤ setting frequency ≤ 6 GHz) Aux 1, Aux 2 -110 to 0 dBm (0.4 GHz ≤ setting frequency ≤ 6 GHz) Setting resolution: 0.1 dB</p> <p>Accuracy Main 1, Main 2 After Cal, with CW, 0.4 GHz ≤ setting frequency < 3 GHz, output level ≥ -100 dBm ±0.7 dB (typ.) ±1.0 dB (+18°C to +28°C) ±1.3 dB (+5°C to +40°C) After Cal, with CW, 3 GHz ≤ setting frequency ≤ 6 GHz, output level ≥ -100 dBm ±1.0 dB (+18°C to +28°C) ±1.3 dB (+5°C to +40°C)</p> <p>Aux 1, Aux 2 After Cal, with CW, 0.4 GHz ≤ setting frequency < 3 GHz, output level ≥ -100 dBm ±0.7 dB (typ.) ±1.0 dB (+18°C to +28°C) ±1.3 dB (+5°C to +40°C) After Cal, with CW, 3 GHz ≤ setting frequency ≤ 4.2 GHz, output level ≥ -100 dBm ±1.0 dB (+18°C to +28°C) ±1.3 dB (+5°C to +40°C) After Cal, with CW, 4.2 GHz < setting frequency ≤ 6 GHz, output level ≥ -100 dBm ±1.5 dB (+18°C to +28°C) ±2.0 dB (+5°C to +40°C)</p> <p>Signal purity Non-harmonic spurious With CW, 0.4 GHz ≤ setting frequency < 0.6 GHz, maximum output level, setting frequency ±10 MHz (exclude <0.4 GHz), exclude setting frequency ±2.5 MHz ≤-40 dBc With CW, 0.6 GHz ≤ setting frequency < 3.3 GHz, maximum output level, non-harmonic on setting frequency ±100 MHz, exclude setting frequency ±2.5 MHz ≤-40 dBc With CW, 3.3 GHz ≤ setting frequency ≤ 6 GHz, maximum output level, non-harmonic on setting frequency ±200 MHz, exclude setting frequency ±2.5 MHz ≤-40 dBc With CW, 0.4 GHz ≤ setting frequency < 0.6 GHz, maximum output level, 0.4 GHz ≤ non-harmonic frequency ≤ 6 GHz, exclude setting frequency ±10 MHz ≤-30 dBc With CW, 0.6 GHz ≤ setting frequency < 3.3 GHz, maximum output level, 0.4 GHz ≤ non-harmonic frequency ≤ 6 GHz, exclude setting frequency ±100 MHz ≤-30 dBc With CW, 3.3 GHz ≤ setting frequency ≤ 6 GHz, maximum output level, 0.4 GHz ≤ non-harmonic frequency ≤ 6.2 GHz, exclude setting frequency ±200 MHz ≤-30 dBc</p> <p>Harmonic spurious With CW, 0.4 GHz ≤ setting frequency ≤ 3 GHz, maximum output level ≤-25 dBc</p> <p>Maximum modulation bandwidth 20 MHz (0.4 GHz ≤ setting frequency < 0.6 GHz) 200 MHz (0.6 GHz ≤ setting frequency < 3.3 GHz) 400 MHz (3.3 GHz ≤ setting frequency ≤ 6 GHz)</p>
------------------------------	------------------------------------------------------------------------------------------------------------------------------------------------------------------------------------------------------------------------------------------------------------------------------------------------------------------------------------------------------------------------------------------------------------------------------------------------------------------------------------------------------------------------------------------------------------------------------------------------------------------------------------------------------------------------------------------------------------------------------------------------------------------------------------------------------------------------------------------------------------------------------------------------------------------------------------------------------------------------------------------------------------------------------------------------------------------------------------------------------------------------------------------------------------------------------------------------------------------------------------------------------------------------------------------------------------------------------------------------------------------------------------------------------------------------------------------------------------------------------------------------------------------------------------------------------------------------------------------------------------------------------------------------------------------------------------------------------------------------------------------------------------------------------------------------------------------------------------------------------------------------------------------------------------------------------------------------------------------------------------------------------------------------------------------------------------------------------------------------------------------------------------------------------------------------------------------------------------------------------------------------------------------------------------------------------------------------------------------------------------------------------------------------------------------------------------------------------------------------------------------------------------------------------------------------------------------------------------------------------------------------------------------------------------------------------------------------------------------------------------------------------------------------------------------------------------------------------------------------------------------------------------------------------------------------------------------------------------------------------------------------------------------------------------------------------------------------------------------------------------------------

Radio Communication Test Station MT8000A Specifications

Receiving Characteristics	<p>Frequency Setting range: 0.4 GHz to 6 GHz Setting resolution: 1 Hz</p> <p>Level Maximum input level: +30 dBm, 0 VDC (0.4 GHz ≤ setting frequency ≤ 6 GHz, with CW) Setting range: -50 to +26 dBm Setting resolution: 0.1 dB</p> <p>Amplitude Measurement resolution: 0.01 dB Measurement accuracy After Cal, with CW, 0.4 GHz ≤ setting frequency < 3 GHz, measurement bandwidth is 100 MHz, at the signal equal to the setting frequency and the setting level ±0.5 dB (Setting level ≥ -20 dBm, typical) ±0.7 dB (Setting level ≥ -40 dBm, typical) ±1.0 dB (Setting level ≥ -40 dBm, +18°C to +28°C) ±1.3 dB (Setting level ≥ -50 dBm, +18°C to +28°C) After Cal, with CW, 3 GHz ≤ setting frequency ≤ 6 GHz, measurement bandwidth is 100 MHz, at the signal equal to the setting frequency and the setting level ±1.0 dB (Setting level ≥ -40 dBm, +18°C to +28°C) ±1.3 dB (Setting level ≥ -50 dBm, +18°C to +28°C)</p>
---------------------------	----------------------------------------------------------------------------------------------------------------------------------------------------------------------------------------------------------------------------------------------------------------------------------------------------------------------------------------------------------------------------------------------------------------------------------------------------------------------------------------------------------------------------------------------------------------------------------------------------------------------------------------------------------------------------------------------------------------------------------------------------------------------------------------------------------------------------------------------------------------------------------------------------------------------------------------------------------------------------------------------------------------------------------------------------------------------------------------------------------------------------------------------------------------------------------

3 GHz-12 GHz RF Sub Module MT8000A-022

Extend RF 2.4 GHz-3 GHz MT8000A-023

Extend RF 6 GHz-7.125 GHz MT8000A-024

General	<p>RF input/output connector Main 1, Main 2 Connector: N (f) Impedance: 50Ω (nom.) VSWR At 2.4 GHz ≤ setting frequency < 3 GHz, with MT8000A-023 ≤1.7 (2.3 GHz ≤ frequency < 3.1 GHz) At 3 GHz ≤ setting frequency ≤ 6 GHz ≤1.5 (2.9 GHz ≤ frequency ≤ 6.1 GHz) At 6 GHz < setting frequency ≤ 7.125 GHz, with MT8000A-024 ≤1.7 (5.9 GHz < frequency ≤ 7.225 GHz)</p> <p>RF output connector Aux 1, Aux 2 Connector: N (f) Impedance: 50Ω (nom.) VSWR At 2.4 GHz ≤ setting frequency ≤ 4.2 GHz, with MT8000A-023 ≤1.8 (2.3 GHz ≤ frequency ≤ 4.3 GHz) At 3 GHz ≤ setting frequency ≤ 4.2 GHz, without MT8000A-023 ≤1.8 (2.9 GHz ≤ frequency ≤ 4.3 GHz) At 4.2 GHz < setting frequency ≤ 6 GHz ≤2.0 (4.1 GHz < frequency ≤ 6.1 GHz) At 6 GHz < setting frequency ≤ 7.125 GHz, with MT8000A-024 ≤2.2 (5.9 GHz < frequency ≤ 7.225 GHz)</p>
---------	------------------------------------------------------------------------------------------------------------------------------------------------------------------------------------------------------------------------------------------------------------------------------------------------------------------------------------------------------------------------------------------------------------------------------------------------------------------------------------------------------------------------------------------------------------------------------------------------------------------------------------------------------------------------------------------------------------------------------------------------------------------------------------------------------------------------------------------------------------------------------------------------------------------------------------------------------------------------------------------------------------------------------------------------------------------------------------------------------------------------------------------------------------------------------------------------------------------------------------------------------

Radio Communication Test Station MT8000A Specifications

<p>Transmission Characteristics</p>	<p>Frequency Setting range: 2 GHz to 12 GHz Setting resolution: 1 Hz Accuracy: Depend on accuracy of reference oscillator</p> <p>Level Setting range Main 1, Main 2 -110 to -10 dBm (2 GHz ≤ setting frequency ≤ 6 GHz) -110 to -18 dBm (6 GHz < setting frequency ≤ 12 GHz) Aux 1, Aux 2 -110 to 0 dBm (2 GHz ≤ setting frequency ≤ 6 GHz) -110 to -8 dBm (6 GHz < setting frequency ≤ 12 GHz) Setting resolution: 0.1 dB</p> <p>Accuracy Main 1, Main 2 After Cal, with CW, 2.4 GHz ≤ setting frequency < 3 GHz, output level ≥ -100 dBm, with MT8000A-023 ±0.7 dB (typ.) ±1.0 dB (+18°C to +28°C) ±1.3 dB (+5°C to +40°C) After Cal, with CW, 3 GHz ≤ setting frequency ≤ 6 GHz, output level ≥ -100 dBm ±1.0 dB (+18°C to +28°C) ±1.3 dB (+5°C to +40°C) After Cal, with CW, 6 GHz < setting frequency ≤ 7.125 GHz, output level ≥ -100 dBm, with MT8000A-024 ±1.3 dB (+18°C to +28°C) ±1.6 dB (+5°C to +40°C) Aux 1, Aux 2 After Cal, with CW, 2.4 GHz ≤ setting frequency < 3 GHz, output level ≥ -100 dBm, with MT8000A-023 ±0.7 dB (typ.) ±1.0 dB (+18°C to +28°C) ±1.3 dB (+5°C to +40°C) After Cal, with CW, 3 GHz ≤ setting frequency ≤ 4.2 GHz, output level ≥ -100 dBm ±1.0 dB (+18°C to +28°C) ±1.3 dB (+5°C to +40°C) After Cal, with CW, 4.2 GHz < setting frequency ≤ 6 GHz, output level ≥ -100 dBm ±1.5 dB (+18°C to +28°C) ±2.0 dB (+5°C to +40°C) After Cal, with CW, 6 GHz < setting frequency ≤ 7.125 GHz, output level ≥ -100 dBm, with MT8000A-024 ±1.5 dB (typ.) ±1.8 dB (+18°C to +28°C) ±2.3 dB (+5°C to +40°C)</p> <p>Signal purity Non-harmonic spurious With CW, maximum output level, setting frequency ±100 MHz, exclude setting frequency ±2.5 MHz ≤ -40 dBc (2.4 GHz ≤ setting frequency ≤ 6 GHz, with MT8000A-023) ≤ -40 dBc (3 GHz ≤ setting frequency ≤ 6 GHz, without MT8000A-023) ≤ -40 dBc (2.4 GHz ≤ setting frequency ≤ 7.125 GHz, with MT8000A-023 and MT8000A-024) ≤ -40 dBc (3 GHz ≤ setting frequency ≤ 7.125 GHz, without MT8000A-023, with MT8000A-024) With CW, maximum output level, exclude setting frequency ±100 MHz ≤ -30 dBc (2.4 GHz ≤ setting frequency ≤ 6 GHz, 2.3 GHz ≤ non-harmonic frequency ≤ 6.1 GHz, with MT8000A-023) ≤ -30 dBc (3 GHz ≤ setting frequency ≤ 6 GHz, 2.9 GHz ≤ non-harmonic frequency ≤ 6.1 GHz, without MT8000A-023) ≤ -30 dBc (2.4 GHz ≤ setting frequency ≤ 7.125 GHz, 2.3 GHz ≤ non-harmonic frequency ≤ 7.225 GHz, with MT8000A-023 and MT8000A-024) ≤ -30 dBc (3 GHz ≤ setting frequency ≤ 7.125 GHz, 2.9 GHz ≤ non-harmonic frequency ≤ 7.225 GHz, without MT8000A-023, with MT8000A-024) Maximum modulation bandwidth: 200 MHz (2 GHz ≤ setting frequency ≤ 6 GHz) 1 GHz (6 GHz < setting frequency ≤ 12 GHz)</p>
<p>Receiving Characteristics</p>	<p>Frequency Setting range: 2 GHz to 12 GHz (Center frequency setting range of measurement software) Setting resolution: 1 Hz</p> <p>Level Maximum input level: +35 dBm, 0 VDC (2.4 GHz ≤ setting frequency ≤ 6 GHz, with CW, with MT8000A-023) +35 dBm, 0 VDC (3 GHz ≤ setting frequency ≤ 6 GHz, with CW, without MT8000A-023) +30 dBm, 0 VDC (6 GHz < setting frequency ≤ 12 GHz, with CW) Setting range: -50 to +26 dBm Setting resolution: 0.1 dB</p> <p>Amplitude Measurement resolution: 0.01 dB Measurement accuracy: At the signal equal to the setting frequency and the setting level After Cal, with CW, 2.4 GHz ≤ setting frequency < 3 GHz, measurement bandwidth is 100 MHz, with MT8000A-023 ±0.5 dB (Setting level ≥ -20 dBm, typ.) ±0.7 dB (Setting level ≥ -40 dBm, typ.) ±1.0 dB (Setting level ≥ -40 dBm, +18°C to +28°C) ±1.3 dB (Setting level ≥ -50 dBm, +18°C to +28°C) After Cal, with CW, 3 GHz ≤ setting frequency ≤ 6 GHz, measurement bandwidth is 100 MHz ±1.0 dB (Setting level ≥ -40 dBm, +18°C to +28°C) ±1.3 dB (Setting level ≥ -50 dBm, +18°C to +28°C) After Cal, with CW, 6 GHz < setting frequency ≤ 7.125 GHz, measurement bandwidth is 100 MHz, with MT8000A-024 ±1.3 dB (Setting level ≥ -40 dBm, +18°C to +28°C) ±1.6 dB (Setting level ≥ -50 dBm, +18°C to +28°C)</p>

Radio Communication Test Station MT8000A Specifications

0.4 GHz-6 GHz Multi RF Module MT8000A-031, 0.4 GHz-6 GHz Multi RF Extension MT8000A-032

General	<p>RF input/output connector Main 1, Main 2 Connector: N (f) Impedance: 50Ω (nom.) VSWR: ≤1.5 (0.4 GHz ≤ frequency ≤ 6 GHz)</p> <p>RF output connector Aux 1, Aux 2, Tx 1, Tx 2 Connector: N (f) Impedance: 50Ω (nom.) VSWR: ≤1.6 (0.4 GHz ≤ frequency ≤ 3.1 GHz) ≤1.9 (3.1 GHz < frequency ≤ 4.3 GHz) ≤2.0 (4.3 GHz < frequency ≤ 6.0 GHz)</p>
Transmission Characteristics	<p>Frequency Setting range: 0.4 GHz to 6.0 GHz (Frequency setting range of measurement software) Setting resolution: 1 Hz Accuracy: Depend on accuracy of reference oscillator</p> <p>Level Setting range Main 1, Main 2 -110 to -10 dBm (0.4 GHz ≤ setting frequency ≤ 6 GHz) Aux 1, Aux 2, Tx 1, Tx 2 -110 to 0 dBm (0.4 GHz ≤ setting frequency ≤ 6 GHz) Setting resolution: 0.1 dB</p> <p>Accuracy Main 1, Main 2 After Cal, with CW, 0.4 GHz ≤ setting frequency < 3 GHz, Setting level ≥-100 dBm ±0.7 dB (Typ.) ±1.0 dB (+18°C to +28°C) ±1.3 dB (+5°C to +40°C) After Cal, with CW, 3 GHz ≤ setting frequency ≤ 6 GHz, Setting level ≥-100 dBm ±1.0 dB (+18°C to +28°C) ±1.3 dB (+5°C to +40°C) Aux 1, Aux 2, Tx 1, Tx 2 After Cal, with CW, 0.4 GHz ≤ setting frequency < 3 GHz, Setting level ≥-100 dBm ±0.7 dB (Typ.) ±1.0 dB (+18°C to +28°C) ±1.3 dB (+5°C to +40°C) After Cal, with CW, 3 GHz ≤ setting frequency ≤ 4.2 GHz, Setting level ≥-100 dBm ±1.0 dB (+18°C to +28°C) ±1.3 dB (+5°C to +40°C) After Cal, with CW, 4.2 GHz < setting frequency ≤ 6 GHz, Setting level ≥-100 dBm ±1.5 dB (+18°C to +28°C) ±2.0 dB (+5°C to +40°C)</p> <p>Signal purity Non-harmonic spurious: With CW, maximum out level ≤-40 dBc (0.4 GHz ≤ setting frequency < 0.6 GHz, non-harmonic spurious within setting frequency ±10 MHz, exclude setting frequency < 0.4 GHz, exclude non-harmonic spurious within setting frequency ±2.5 MHz) ≤-40 dBc (0.6 GHz ≤ setting frequency ≤ 6 GHz, non-harmonic spurious within setting frequency ±100 MHz, exclude non-harmonic spurious within setting frequency ±2.5 MHz) ≤-30 dBc (0.4 GHz ≤ setting frequency < 0.6 GHz, 0.4 GHz ≤ non-harmonic spurious ≤ 6 GHz, exclude non-harmonic spurious within setting frequency ±10 MHz) ≤-30 dBc (0.6 GHz ≤ setting frequency < 3.3 GHz, 0.4 GHz ≤ non-harmonic spurious ≤ 6 GHz, exclude non-harmonic spurious within setting frequency ±100 MHz) ≤-30 dBc (3.3 GHz ≤ setting frequency ≤ 6 GHz, 0.4 GHz ≤ non-harmonic spurious ≤ 6.1 GHz, exclude non-harmonic spurious within setting frequency ±100 MHz) Harmonic spurious: With CW, maximum out level ≤-25 dBc (0.4 GHz ≤ setting frequency ≤ 3 GHz)</p> <p>Maximum modulation bandwidth 20 MHz (0.4 GHz ≤ setting frequency < 0.6 GHz) 200 MHz (0.6 GHz ≤ setting frequency ≤ 6 GHz)</p>
Receiving Characteristics	<p>Frequency Setting range: 0.4 GHz to 6 GHz (Frequency setting range of measurement software) Setting resolution: 1 Hz</p> <p>Level Maximum input level: +35 dBm, 0 VDC (with CW, 0.4 GHz ≤ setting frequency ≤ 6 GHz) Setting range: -50 to +26 dBm Setting resolution: 0.1 dB</p> <p>Amplitude Measurement resolution: 0.01 dB Measurement accuracy: After Cal, with CW, at the signal equal to the setting frequency and the setting level 0.4 GHz ≤ setting frequency ≤ 0.6 GHz, measurement bandwidth 10 MHz ±0.5 dB (setting level ≥-20 dBm, typ.) ±0.7 dB (setting level ≥-40 dBm, typ.) ±1.0 dB (setting level ≥-40 dBm, +18°C to +28°C) ±1.3 dB (setting level ≥-50 dBm, +18°C to +28°C) 0.6 GHz < setting frequency < 3 GHz, measurement bandwidth 100 MHz ±0.5 dB (setting level ≥-20 dBm, typ.) ±0.7 dB (setting level ≥-40 dBm, typ.) ±1.0 dB (setting level ≥-40 dBm, +18°C to +28°C) ±1.3 dB (setting level ≥-50 dBm, +18°C to +28°C) 3 GHz ≤ setting frequency ≤ 6 GHz, measurement bandwidth 100 MHz ±1.0 dB (setting level ≥-40 dBm, +18°C to +28°C) ±1.3 dB (setting level ≥-50 dBm, +18°C to +28°C)</p>

Radio Communication Test Station MT8000A Specifications

0.4 GHz-7.125 GHz Enhanced RF Module MT8000A-033

General	<p>RF input/output connector Main 1, Main 2, Main 3, Main 4 Connector: N (J) type Impedance: 50Ω (nom.) VSWR: ≤1.7 (0.4 GHz ≤ frequency ≤ 0.6 GHz) ≤1.5 (0.6 GHz < frequency ≤ 5.0 GHz) ≤1.9 (5.0 GHz < frequency ≤ 7.6 GHz)</p> <p>RF output connector Aux 1, Aux 2, Aux 3, Aux 4 Connector: N (J) type Impedance: 50Ω (nom.) VSWR: ≤1.8 (0.4 GHz ≤ frequency ≤ 0.6 GHz) ≤1.7 (0.6 GHz < frequency ≤ 3.0 GHz) ≤1.9 (3.0 GHz < frequency ≤ 4.2 GHz) ≤2.0 (4.2 GHz < frequency ≤ 6.0 GHz) ≤2.2 (6.0 GHz < frequency ≤ 7.6 GHz)</p>
IF Input/Output Connector	<p>RF Converter B1, B2 Connector: SMA (f) Impedance: 50Ω (nom.)</p>
External Interface	<p>RF Converter A1, A2: Round multiway type connector</p>
Transmission Characteristics	<p>Frequency Setting range: 0.4 GHz to 5.0 GHz (Internal signal generator Tx-A) 0.4 GHz to 7.125 GHz (Internal signal generator Tx-B) Setting resolution: 1 Hz (Tx-A, Tx-B) Accuracy: Depend on accuracy of reference oscillator</p> <p>Level Setting range Main 1, Main 2, Main 3, Main 4 -110 to -10 dBm (0.4 GHz ≤ frequency ≤ 7.125 GHz) Aux 1, Aux 2, Aux 3, Aux 4 -110 to 0 dBm (0.4 GHz ≤ frequency ≤ 7.125 GHz) Setting resolution: 0.1 dB Accuracy Main 1, Main 2, Main 3, Main 4 After calibration, CW, 0.4 GHz ≤ Set frequency ≤ 0.6 GHz, -100 dBm ≤ Output Level, Use of either Tx-A or Tx-B signal output, Use of both Tx-A and Tx-B signal output, Each output with a signal level difference between Tx-A and Tx-B ≤ 25 dB ±0.7 dB (Typ.) ±1.0 dB (+18°C to +28°C) ±1.4 dB (+5°C to +40°C) After calibration, CW, 0.6 GHz < Set frequency ≤ 3.0 GHz, -100 dBm ≤ Output Level, Use of either Tx-A or Tx-B signal output, Use of both Tx-A and Tx-B signal output, Each output with a signal level difference between Tx-A and Tx-B ≤ 25 dB ±0.7 dB (Typ.) ±1.0 dB (+18°C to +28°C) ±1.3 dB (+5°C to +40°C) After calibration, CW, 3.0 GHz < Set frequency ≤ 5.0 GHz, -100 dBm ≤ Output Level, Use of either Tx-A or Tx-B signal output, Use of both Tx-A and Tx-B signal output, Each output with a signal level difference between Tx-A and Tx-B ≤ 25 dB ±1.0 dB (+18°C to +28°C) ±1.3 dB (+5°C to +40°C) After calibration, CW, 5.0 GHz < Set frequency ≤ 7.125 GHz, -100 dBm ≤ Output Level Use of either Tx-A or Tx-B signal output, Use of both Tx-A and Tx-B signal output, Each output with a signal level difference between Tx-A and Tx-B ≤ 25 dB ±1.0 dB (+18°C to +28°C) ±1.5 dB (+5°C to +40°C) Aux 1, Aux 2, Aux 3, Aux 4 After calibration, CW, 0.4 GHz ≤ Set frequency ≤ 0.6 GHz, -100 dBm ≤ Output Level Use of either Tx-A or Tx-B signal output, Use of both Tx-A and Tx-B signal output, Each output with a signal level difference between Tx-A and Tx-B ≤ 25 dB ±0.7 dB (Typ.) ±1.0 dB (+18°C to +28°C) ±1.5 dB (+5°C to +40°C) After calibration, CW, 3.0 GHz < Set frequency ≤ 4.2 GHz, -100 dBm ≤ Output Level Use of either Tx-A or Tx-B signal output, Use of both Tx-A and Tx-B signal output, Each output with a signal level difference between Tx-A and Tx-B ≤ 25 dB ±1.0 dB (+18°C to +28°C) ±1.3 dB (+5°C to +40°C) After calibration, CW, 4.2 GHz < Set frequency ≤ 6.0 GHz, -100 dBm ≤ Output Level Use of either Tx-A or Tx-B signal output, Use of both Tx-A and Tx-B signal output, Each output with a signal level difference between Tx-A and Tx-B ≤ 25 dB ±1.0 dB (nom.) ±1.5 dB (+18°C to +28°C) ±2.0 dB (+5°C to +40°C) After calibration, CW, 6 GHz < Set frequency ≤ 7.125 GHz, -100 dBm ≤ Output Level Use of either Tx-A or Tx-B signal output, Use of both Tx-A and Tx-B signal output, Each output with a signal level difference between Tx-A and Tx-B ≤ 25 dB ±1.5 dB (Typ.) ±1.8 dB (+18°C to +28°C) ±2.3 dB (+5°C to +40°C)</p>

Radio Communication Test Station MT8000A Specifications

<p>Transmission Characteristics (continued)</p>	<p>Signal purity Non-harmonic spurious CW, use of either Tx-A or Tx-B signal output, Max Output Level, other output levels are OFF 0.4 GHz ≤ Set frequency ≤ 0.6 GHz, 0.4 GHz ≤ Non-harmonic of Set frequency ≤ 7.125 GHz, except Set frequency within ±10 MHz ≤ -40 dBc CW, use of either Tx-A or Tx-B signal output, Max Output Level, other output levels are OFF 0.6 GHz < Set frequency ≤ 7.125 GHz, 0.4 GHz ≤ Non-harmonic of Set frequency ≤ 7.125 GHz, except Set frequency within ±100 MHz ≤ -40 dBc Harmonic spurious CW, use of either Tx-A or Tx-B signal output, Max Output Level, other output levels are OFF 0.4 GHz ≤ Set frequency ≤ 3.5625 GHz ≤ -25 dBc Maximum modulation bandwidth 20 MHz (Set frequency ≤ 0.6 GHz) 400 MHz (0.6 GHz < Set frequency)</p>
<p>Receiving Characteristics</p>	<p>Frequency Setting range: 0.4 GHz to 7.125 GHz Setting resolution: 1 Hz Level Maximum input level: CW, +30 dBm (0.4 GHz ≤ Set frequency ≤ 7.125 GHz), 0 VDC Setting range: -60 to +30 dBm Setting resolution: 0.1 dB Amplitude measurement Measurement resolution: 0.01 dB Measurement accuracy After calibration, CW, 0.4 GHz ≤ Set frequency ≤ 0.6 GHz, Measurement Bandwidth 10 MHz, Measured signal with the same frequency as the set frequency, Measured signal at the same level as the set level With the Main output connector selected, Total power of Tx-A and Tx-B ≤ -20 dBm ±0.5 dB (setting level ≥ -20 dBm, typ.) ±0.7 dB (setting level ≥ -40 dBm, typ.) ±1.0 dB (setting level ≥ -40 dBm, +18°C to +28°C) ±1.3 dB (setting level ≥ -50 dBm, +18°C to +28°C) ±1.6 dB (setting level ≥ -60 dBm, +18°C to +28°C) After calibration, CW, 0.6 GHz < Set frequency ≤ 1.3 GHz, Measurement Bandwidth 20 MHz, Measured signal with the same frequency as the set frequency, Measured signal at the same level as the set level With the Main output connector selected, Total power of Tx-A and Tx-B ≤ -20 dBm ±0.5 dB (setting level ≥ -20 dBm, typ.) ±0.7 dB (setting level ≥ -40 dBm, typ.) ±1.0 dB (setting level ≥ -40 dBm, +18°C to +28°C) ±1.3 dB (setting level ≥ -50 dBm, +18°C to +28°C) ±1.6 dB (setting level ≥ -60 dBm, +18°C to +28°C) After calibration, CW, 1.3 GHz < Set frequency ≤ 3.0 GHz, Measurement Bandwidth 100 MHz, Measured signal with the same frequency as the set frequency, Measured signal at the same level as the set level With the Main output connector selected, Total power of Tx-A and Tx-B ≤ -20 dBm ±0.5 dB (setting level ≥ -20 dBm, typ.) ±0.7 dB (setting level ≥ -40 dBm, typ.) ±1.0 dB (setting level ≥ -40 dBm, +18°C to +28°C) ±1.3 dB (setting level ≥ -50 dBm, +18°C to +28°C) ±1.6 dB (setting level ≥ -60 dBm, +18°C to +28°C) After calibration, CW, 3 GHz < Set frequency ≤ 5 GHz, Measurement Bandwidth 100 MHz, Measured signal with the same frequency as the set frequency, Measured signal at the same level as the set level ±1.0 dB (setting level ≥ -40 dBm, +18°C to +28°C) ±1.3 dB (setting level ≥ -50 dBm, +18°C to +28°C) ±1.6 dB (setting level ≥ -60 dBm, +18°C to +28°C) After calibration, CW, 5 GHz < Set frequency ≤ 6 GHz, Measurement Bandwidth 100 MHz, Measured signal with the same frequency as the set frequency, Measured signal at the same level as the set level ±1.0 dB (setting level ≥ -40 dBm, +18°C to +28°C) ±1.3 dB (setting level ≥ -50 dBm, +18°C to +28°C) ±1.6 dB (setting level ≥ -60 dBm, +18°C to +28°C) After calibration, CW, 6 GHz < Set frequency ≤ 7.125 GHz, Measurement Bandwidth 100 MHz, Measured signal with the same frequency as the set frequency, Measured signal at the same level as the set level ±1.0 dB (setting level ≥ -40 dBm, +18°C to +28°C) ±1.3 dB (setting level ≥ -50 dBm, +18°C to +28°C) Linearity After calibration, CW, 0.4 GHz ≤ Set frequency ≤ 0.6 GHz, Set level ≥ -10 dBm, Measurement Bandwidth 100 MHz, Measured signal with the same frequency as the set frequency, Measured signal up to the level 40 dB lower than the set level ±0.15 dB (Typ.) After calibration, CW, 0.6 GHz < Set frequency ≤ 7.125 GHz, Set level ≥ -10 dBm, Measurement Bandwidth 20 MHz, With the Main output connector selected, Total power of Tx-A and Tx-B ≤ -20 dBm, Measured signal with the same frequency as the set frequency, Measured signal up to the level 40 dB lower than the set level ±0.15 dB (Typ.) After calibration, CW, 0.6 GHz < Set frequency ≤ 7.125 GHz, Set level ≥ -10 dBm, Measurement Bandwidth 100 MHz, Measured signal with the same frequency as the set frequency, Measured signal up to the level 20 dB lower than the set level ±0.15 dB (Typ.) Measured signal up to the level 30 dB lower than the set level ±0.34 dB (Typ.)</p>

Radio Communication Test Station MT8000A Specifications

Peripherals

28 GHz RF Converter MA80001A

RF Input/Output Connector	Port 1, Port 2 Connector: K (m) Impedance: 50Ω (nom.) VSWR (when transmitted): ≤2.5 (23.75 GHz ≤ frequency ≤ 30 GHz) VSWR (when received): ≤2.5 (23.45 GHz ≤ frequency ≤ 30.3 GHz)	
Transmission Characteristics	Frequency Setting range: 24.25 GHz to 29.5 GHz (Center frequency setting range of measurement software) Setting resolution: 1 Hz Accuracy: Depend on accuracy of MT8000A reference oscillator Level Setting range: -90 to +5 dBm Setting resolution: 0.1 dB Accuracy: ±1.5 dB (+18°C to +28°C, after Cal, with CW) Signal purity Non-harmonic spurious With CW, maximum output level ≤-40 dBc (non-harmonic on setting frequency ±500 MHz, non-harmonic, exclude setting frequency ±50 MHz) ≤-30 dBc (23.75 GHz ≤ non-harmonic frequency ≤ 30 GHz, exclude setting frequency within ±500 MHz and -4500 MHz) Maximum modulation bandwidth: 1 GHz	
Receiving Characteristics	Frequency Setting range: 24.25 GHz to 29.5 GHz (Center frequency setting range of measurement software) Setting resolution: 1 Hz Level Maximum input level: +20 dBm, 0 VDC (with CW) Setting range: -70 to +5 dBm Setting resolution: 0.1 dB Amplitude Measurement resolution: 0.01 dB Measurement accuracy: At the signal equal to the setting frequency and the setting level After Cal, with CW, 24.25 GHz ≤ setting frequency ≤ 29.5 GHz, measurement bandwidth 100 MHz, +18°C to +28°C ±1.5 dB (-50 dBm ≤ setting level ≤ +5 dBm) ±2.5 dB (-70 dBm ≤ setting level < -50 dBm)	
IF Input/Output Connector	Connect to MT8000A: B Connector: N (f) Impedance: 50Ω (nom.)	
External Control Connector	Round multiway type connector	
DC Input Connector	Voltage: 12 VDC Current: ≤3 A	
Dimensions and Mass	Dimensions: 92 (W) × 175 (H) × 260 (D) mm (excluding projections) Mass: ≤6 kg	
Environmental Conditions	Operating temperature range: +5°C to +40°C (without condensation) Storage temperature range: -20°C to +71°C (without condensation)	
CE	EMC	2014/30/EU, EN61326-1, EN61000-3-2
	LVD	2014/35/EU, EN61010-1
	RoHS	2011/65/EU, (EU) 2015/863, EN IEC 63000: 2018
UKCA	EMC	S.I. 2016 No.1091, EN 61326-1, EN61000-3-2
	LVD	S.I. 2016 No.1101, EN 61010-1
	RoHS	S.I. 2012 No.3032, EN IEC 63000:2018

Radio Communication Test Station MT8000A Specifications

Peripherals

39 GHz RF Converter MA80002A

RF Input/Output Connector	Port 1, Port 2 Connector: K (m) Impedance: 50Ω (nom.) VSWR: ≤2.9 (36.2 GHz ≤ frequency ≤ 40.0 GHz)	
Transmission Characteristics	Frequency Setting range: 37.0 GHz to 42.5 GHz (Center frequency setting range of measurement software) Setting resolution: 1 Hz Accuracy: Depend on accuracy of MT8000A reference oscillator Level Setting range: -90 to +5 dBm Setting resolution: 0.1 dB Accuracy: ±1.5 dB (typ., after Cal, with CW, 37.0 GHz ≤ setting frequency ≤ 40.0 GHz) ±2.0 dB (+18°C to +28°C, after Cal, with CW, 37.0 GHz ≤ setting frequency ≤ 40.0 GHz) Signal purity Non-harmonic spurious With CW, maximum output level, 37.0 GHz ≤ setting frequency ≤ 40.0 GHz ≤-40 dBc (non-harmonic on setting frequency ±500 MHz, exclude non-harmonic frequency >40.0 GHz and setting frequency ±50 MHz) ≤-30 dBc (36.5 GHz ≤ non-harmonic frequency ≤ 40.0 GHz, exclude setting frequency ±500 MHz) Maximum modulation bandwidth: 1 GHz	
Receiving Characteristics	Frequency Setting range: 37.0 GHz to 42.5 GHz (Center frequency setting range of measurement software) Setting resolution: 1 Hz Level Maximum input level: +17 dBm, 0 VDC (with CW) Setting range: -70 to +5 dBm Setting resolution: 0.1 dB Amplitude Measurement resolution: 0.01 dB Measurement accuracy: At the signal equal to the setting frequency and the setting level After Cal, with CW, 37.0 GHz ≤ setting frequency ≤ 40.0 GHz, measurement bandwidth 100 MHz ±1.5 dB (-50 dBm ≤ setting level ≤ +5 dBm, typ.) ±2.0 dB (-70 dBm ≤ setting level < -50 dBm, typ.) ±2.0 dB (-50 dBm ≤ setting level ≤ +5 dBm, +18°C to +28°C) ±2.5 dB (-70 dBm ≤ setting level < -50 dBm, +18°C to +28°C)	
IF Input/Output Connector	Connect to MT8000A: B Connector: N (f) Impedance: 50Ω (nom.)	
External Control Connector	Round multiway type connector	
DC Input Connector	Voltage: 12 VDC Current: ≤4 A	
Dimensions and Mass	Dimensions: 92 (W) × 175 (H) × 304 (D) mm (excluding projections) Mass: ≤6 kg	
Environmental Conditions	Operating temperature range: +5°C to +40°C (without condensation) Storage temperature: -20°C to +71°C (without condensation)	
CE	EMC	2014/30/EU, EN61326-1, EN61000-3-2
	LVD	2014/35/EU, EN61010-1
	RoHS	2011/65/EU, (EU) 2015/863, EN IEC 63000: 2018
UKCA	EMC	S.I. 2016 No.1091, EN 61326-1, EN61000-3-2
	LVD	S.I. 2016 No.1101, EN 61010-1
	RoHS	S.I. 2012 No.3032, EN IEC 63000:2018

Radio Communication Test Station MT8000A Specifications

Peripherals

Multiband RF Converter MA80003A

RF Input/Output Connector	Port 1, Port 2 Connector: V (m) Impedance: 50Ω (nom.) VSWR: ≤2.5 (22.65 GHz ≤ frequency ≤ 31.1 GHz) ≤2.9 (35.4 GHz ≤ frequency ≤ 43.5 GHz) ≤2.9 (43.5 GHz < frequency ≤ 45.1 GHz, typ.)	
Transmission Characteristics	Frequency Setting range: 24.25 GHz to 29.5 GHz, 37.0 GHz to 43.5 GHz Setting resolution: 1 Hz Accuracy: Depend on accuracy of MT8000A reference oscillator Level Setting range: -70 to +15 dBm Setting resolution: 0.1 dB Accuracy: After Cal, with CW, Setting level ≤ ±10 dBm ±1.5 dB (24.25 GHz ≤ setting frequency ≤ 29.5 GHz, +18°C to +28°C) ±1.5 dB (37.0 GHz ≤ setting frequency ≤ 40.0 GHz, typ.) ±2.0 dB (37.0 GHz ≤ setting frequency ≤ 40.0 GHz, +18°C to +28°C) ±1.5 dB (40.0 GHz < setting frequency ≤ 43.5 GHz, typ.) ±2.0 dB (40.0 GHz < setting frequency ≤ 43.5 GHz, +18°C to +28°C) Signal purity Non-harmonic spurious: With CW, Setting level = +10 dBm In-band Specification: ≤-40 dBc (non-harmonic on setting frequency ±500 MHz, exclude setting frequency ±500 MHz and non-harmonic frequency < 24.25 GHz, 29.5 GHz < non-harmonic frequency < 37.0 GHz and non-harmonic frequency > 43.5 GHz) Specification for interference signal source: ≤-37 dBc (non-harmonic on setting frequency ±1.5 GHz, exclude setting frequency ±500 MHz and non-harmonic frequency < 24.25 GHz, 29.5 GHz < non-harmonic frequency < 37.0 GHz and non-harmonic frequency > 43.5 GHz) Out-of-band Specification: ≤-30 dBc (24.25 GHz ≤ setting frequency ≤ 29.5 GHz, 24.25 GHz ≤ non-harmonic frequency ≤ 29.5 GHz and 37.0 GHz ≤ non-harmonic frequency ≤ 43.5 GHz, exclude setting frequency ±1.5 GHz, setting frequency - 4.5 GHz ±10 MHz and setting frequency + 4.5 GHz ±10 MHz) ≤-30 dBc (37.0 GHz ≤ setting frequency ≤ 43.5 GHz, 24.25 GHz ≤ non-harmonic frequency ≤ 29.5 GHz and 37.0 GHz ≤ non-harmonic frequency ≤ 43.5 GHz, exclude setting frequency ±1.5 GHz) Maximum modulation bandwidth: 1 GHz	
Receiving Characteristics	Frequency Setting range: 24.25 GHz to 29.5 GHz, 37.0 GHz to 43.5 GHz Setting resolution: 1 Hz Level Maximum input level: +20 dBm, 0 VDC (with CW) Setting range: -70 to +10 dBm Setting resolution: 0.1 dB Amplitude Measurement resolution: 0.01 dB Measurement accuracy: After Cal, with CW, measurement bandwidth 100 MHz, at the signal equal to the setting frequency and the setting level 24.25 GHz ≤ setting frequency ≤ 29.5 GHz ±1.0 dB (-50 dBm ≤ setting level ≤ +10 dBm, typ.) ±2.0 dB (-70 dBm ≤ setting level < -50 dBm, typ.) ±1.5 dB (-50 dBm ≤ setting level ≤ +10 dBm, +18°C to +28°C) ±2.5 dB (-70 dBm ≤ setting level < -50 dBm, +18°C to +28°C) 37.0 GHz ≤ setting frequency ≤ 40.0 GHz ±1.5 dB (-50 dBm ≤ setting level ≤ +10 dBm, typ.) ±2.0 dB (-70 dBm ≤ setting level < -50 dBm, typ.) ±2.0 dB (-50 dBm ≤ setting level ≤ +10 dBm, +18°C to +28°C) ±2.5 dB (-70 dBm ≤ setting level < -50 dBm, +18°C to +28°C) 40.0 GHz ≤ setting frequency ≤ 43.5 GHz ±1.5 dB (-50 dBm ≤ setting level ≤ +10 dBm, typ.) ±2.0 dB (-65 dBm ≤ setting level < -50 dBm, typ.) ±2.0 dB (-50 dBm ≤ setting level ≤ +10 dBm, +18°C to +28°C) ±2.5 dB (-65 dBm ≤ setting level < -50 dBm, +18°C to +28°C)	
IF Input/Output Connector	Connector: N (f) Impedance: 50Ω (nom.)	
External Control Connector	Round multiway type connector	
DC Input Connector	Voltage: 18 VDC Current: ≤5.5 A	
Dimensions and Mass	Dimensions: 83 (W) × 175 (H) × 304 (D) mm (excluding projections) Mass: ≤6 kg	
Environmental Conditions	Operating temperature range: +5°C to +45°C (without condensation) Storage temperature range: -20°C to +71°C (without condensation)	
CE	EMC	2014/30/EU, EN61326-1, EN61000-3-2
	LVD	2014/35/EU, EN61010-1
	RoHS	2011/65/EU, (EU) 2015/863, EN IEC 63000:2018
UKCA	EMC	S.I. 2016 No.1091, EN 61326-1, EN61000-3-2
	LVD	S.I. 2016 No.1101, EN 61010-1
	RoHS	S.I. 2012 No.3032, EN IEC 63000:2018

See **OTA Product Catalog** for detailed information of Shield Box MA8161A, RF Chamber MA8171A and CATR Anechoic chamber MA8172A.

Radio Communication Test Station MT8000A Ordering Information

Please specify the model/order number, name and quantity when ordering.

The names listed in the chart below are Order Names. The actual name of the item may differ from the Order Name.

Model/Order No.	Name	Model/Order No.	Name
MT8000A	Main Frame Radio Communication Test Station		
	Standard Accessories		
J1211	Power Cord (3.0 m, 100 V, 3 core) :	1 pc	
J1440A	LAN Cable :	1 pc	
W3955AE	MT8000A Operation Manual (DVD) :	1 pc	
MX800000A	Platform Software		
	Options		
MT8000A-001	Control Module		
MT8000A-009	Multi-box Data Connection		
MT8000A-011	Baseband Module		
MT8000A-012	Data Test Module		
MT8000A-020	RF Base Module		
MT8000A-021	0.4 GHz-6 GHz RF Sub Module		
MT8000A-022	3 GHz-12 GHz RF Sub Module		
MT8000A-023	Extend RF 2.4 GHz-3 GHz		
MT8000A-024	Extend RF 6 GHz-7.125 GHz		
MT8000A-031	0.4 GHz-6 GHz Multi RF Module		
MT8000A-032	0.4 GHz-6 GHz Multi RF Extension		
MT8000A-033	0.4 GHz-7.125 GHz Enhanced RF Module		
	Converter		
MA80001A	28 GHz RF Converter		
MA80002A	39 GHz RF Converter		
MA80003A	Multiband RF Converter		
J1771A	Coaxial Cord (N-N, 1.0 m)		
J1771B	Coaxial Cord (N-N, 3.0 m)		
J1879B	Coaxial Cord (N-SMA, 3.0 m)		
J1772A	Control Cable, 1.0 m		
J1772B	Control Cable, 3.0 m		
	Correction Equipments for OTA Measurement		
ML2437A	Power Meter		
MA2444D	Power Sensor		
MA2445D	Power Sensor		
41KC-10	10 dB Attenuator		
J0004	COAXIAL ADAPTOR		
J0008	GPIB CABLE, 2.0M		
K222B	Adaptor		
Z1974A	Reference Antenna		
	Measurement Hardware for NSA		
MT8821C	Radio Communication Analyzer		
MT8821C-008	LTE Measurement Hardware		
MX882112C	LTE FDD Measurement Software		
MX882112C-010	LTE FDD NSA for 5G Anchor		
MX882113C	LTE TDD Measurement Software		
MX882113C-010	LTE TDD NSA for 5G Anchor		
J1802A	Sync Cable		
MD8430A	Signalling Tester		
MD8430A-005	Extended Frequency Range to 3.8 GHz Hardware2		
MD8430A-035	LTE Enhanced Test Model (ETM)		
MD8430A-060	LTE FDD Option		
MD8430A-061	LTE TDD Option		
MD8430A-064	LTE Anchor For 5G NSA Option		
MD8430A-086	Ciphering Option		
MD8430A-SS135	1 Year Support Service for LTE FDD (ETM)		
MD8430A-SS136	1 Year Support Service for LTE TDD (ETM)		
	Application Parts		
Z2017F	Standard PC		
Z2035B	Standard PC for SSNR (with monitor)		
Z1320F	Standard PC for RTD (with monitor)		
Z1320G	Standard PC for RTD (with monitor)		
MT8000A-AK001	Fading Control PC		
MT8000A-AK002	IP Test Server PC		
MT8000A-AK003	IP Test Server PC		
Z1591A	USB Dongle (Protocol)		
Z2023A	USB Dongle (SmartStudio NR)		
G0408A	10 Gig Ethernet SR 850 nm SFP+		
J1875A	Optical cable MM LC/PC to LC/PC 3 m Duplex		
Z1993A	Optical Connector Cleaner (MPO)		
J0127A	COAXIAL CORD, 1.0M		
J1398A	N-SMA ADAPTOR		
J1440A	LAN Cable		
J1773A	AUX Conversion Adapter		
J1798A	GPIB-USB-HS+		
Z2032A	Reference Antenna		
	Software Options		
MX800010A	NR TDD Measurement Software		
MX800010A-001	NR TDD SA Call Processing Software		
MX800010A-002	NR TDD OTA Measurement Software		
MX800010A-003	NR IP Data Transfer		
MX800010A-004	NR IMS Registration		
MX800010A-007	NR TDD Sub-6 GHz Measurement		
MX800010A-008	NR TDD mmWave Measurement		
MX800010A-009	NR FDD Measurement		
MX800010A-010	NR Joint CA Measurement for sub-6 GHz		
MX800010A-011	NR FR1 + FR2 Interworking Measurement		
MX800010A-012	NR Supplementary Uplink Measurement		
MX800010A-014	NR Licensed 6 GHz Band Measurement		
MX800010A-015	NR FR1 RedCap Measurement		
MX800010A-016	NR Measurement for Enhanced UL Capability		
MX800010A-017	NR Joint CA Flexible Scheduling for TDD+FDD		
MX800010A-018	NR Early Decision for CA REFSENS		
MX800010A-024	NR BW 200 MHz Per Cell		
MX800010A-026	EIS-CDF Optimization using Machine Learning		
MX800010A-031	NR TDD DL 2x2 MIMO Up To Total BW 100 MHz		
MX800010A-032	NR TDD DL 2x2 MIMO Up To Total BW 200 MHz		
MX800010A-033	NR TDD DL 2x2 MIMO Up To Total BW 400 MHz		
MX800010A-034	NR TDD DL 2x2 MIMO Up To Total BW 600 MHz		
MX800010A-035	NR TDD DL 2x2 MIMO Up To Total BW 800 MHz		
MX800010A-036	NR TDD DL 4x4 MIMO Up To Total BW 100 MHz		
MX800010A-037	NR TDD DL 4x4 MIMO Up To Total BW 200 MHz		
MX800010A-038	NR TDD DL 4x4 MIMO Up To Total BW 400 MHz		
MX800010A-041	NR TDD DL 2CA For Rx Measurement		
MX800010A-042	NR TDD DL 3CA For Rx Measurement		
MX800010A-043	NR TDD DL 4CA For Rx Measurement		
MX800010A-044	NR TDD DL 5CA For Rx Measurement		
MX800010A-045	NR TDD DL 6CA For Rx Measurement		
MX800010A-046	NR TDD DL 7CA For Rx Measurement		
MX800010A-047	NR TDD DL 8CA For Rx Measurement		
MX800010A-048	NR TDD DL 9CA For Rx Measurement		
MX800010A-051	NR TDD UL 2x2 MIMO Up To Total BW 100 MHz		
MX800010A-052	NR TDD UL 2x2 MIMO Up To Total BW 200 MHz		
MX800010A-053	NR TDD UL 2x2 MIMO Up To Total BW 400 MHz		
MX800010A-054	NR TDD UL 2x2 MIMO Up To Total BW 600 MHz		
MX800010A-061	NR TDD UL 2CA For Tx Measurement		
MX800010A-062	NR TDD UL 3CA For Tx Measurement		
MX800010A-063	NR TDD UL 4CA For Tx Measurement		
MX800010A-064	NR TDD UL 5CA For Tx Measurement		
MX800010A-070	LTE anchor Call Processing Software		
MX800010A-071	LTE TRx Measurement		
MX800010A-072	LTE DL 2 to 4CA		
MX800010A-073	LTE UL 2CA		
MX800010A-074	LTE DL 2x2/4x4 MIMO		
MX800010A-081	NR TDD DL 2x2 MIMO Up To Total BW 1000 MHz		
MX800030A	NR Protocol Platform Software		
MX800030A-001	NR TDD Platform		
MX800030A-002	NR FDD Platform		
MX800030A-003	Ciphering		
MX800030A-004	Internal Server		
MX800030A-005	5G SA Protocol		
MX800030A-006	NR SDAP		
MX800030A-007	NR FDD/TDD Joint CA		
MX800030A-008	NR FR1+FR2 DC Protocol		
MX800030A-009	NR FR1+FR2 CA Protocol		
MX800030A-010	RF/Fading Driver For Multiple box		
MX800030A-011	Over 10 Gbps IP Throughput		
MX800030A-014	NR UL Configured Grant Type1/2		
MX800030A-015	NR DL Semi-Persistent Scheduling		
MX800030A-016	NR Uplink Data Compression		
MX800030A-017	PUSCH/PUCCH DMRS Bundling		
MX800030A-020	NR DCI Format 0_2/1_2		
MX800030A-021	NR Supplementary Uplink		

Radio Communication Test Station MT8000A Ordering Information

Model/Order No.	Name
MX800030A-022	SCell Dormancy
MX800030A-024	Paging Early Indication
MX800030A-025	2Step RACH
MX800030A-026	Cross Carrier Scheduling For DC/CA Enh.
MX800030A-027	Wake Up Indication For Power Saving
MX800030A-028	Dual Active Protocol Stack Handover For Mobility Enh.
MX800030A-029	NR eDRX
MX800030A-031	NR DL 2×2 MIMO BW 50 MHz Per Cell
MX800030A-032	NR DL 2×2 MIMO BW 100 MHz Per Cell
MX800030A-033	NR DL 2×2 MIMO BW 200 MHz Per Cell
MX800030A-035	NR DL 4×4 MIMO BW 50 MHz Per Cell
MX800030A-036	NR DL 4×4 MIMO BW 100 MHz Per Cell
MX800030A-041	NR UL 2×2 MIMO BW 50 MHz Per Cell
MX800030A-042	NR UL 2×2 MIMO BW 100 MHz Per Cell
MX800030A-043	NR UL 2×2 MIMO BW 200 MHz Per Cell
MX800030A-051	NR DL 2CA For Protocol
MX800030A-052	NR DL 3CA For Protocol
MX800030A-053	NR DL 4CA For Protocol
MX800030A-054	NR DL 5CA For Protocol
MX800030A-055	NR DL 6CA For Protocol
MX800030A-056	NR DL 7CA For Protocol
MX800030A-057	NR DL 8CA For Protocol
MX800030A-058	NR DL 9CA For Protocol
MX800030A-059	NR DL 10CA For Protocol
MX800030A-061	NR UL 2CA For Protocol
MX800030A-062	NR UL 3CA For Protocol
MX800030A-063	NR UL 4CA For Protocol
MX800030A-071	Digital IQ Basic For Protocol
MX800031A	NR Fading Basic
MX800031A-001	NR Fading 2×2 MIMO
MX800031A-002	NR Fading 4×2/4×4 MIMO
MX800031A-003	NR Fading 2CA-4CA
MX800031A-004	NR Fading 5CA-8CA
MX800031A-005	NR Fading 8×2/8×4 MIMO
MX800032A	LTE Protocol Platform Software
MX800032A-001	LTE Anchor For Protocol
MX800032A-002	LTE Advance Features
MX800032A-010	LTE RF/Fading Driver For Multiple box
MX800033A	LTE Fading Basic
MX800037A	LTE/NR Protocol Platform Software
MX800050A	Rapid Test Designer Platform (RTD)
MX800050A-001	5G NSA Framework For RTD
MX800050A-002	RTD LL/L3 Procedure Libraries (5G)
MX800050A-003	Core LTE Framework For RTD
MX800050A-004	UTRAN/GERAN Framework For RTD
MX800050A-005	IMS Framework For RTD
MX800050A-006	IoT Framework For RTD
MX800050A-007	LTE-A Framework For RTD
MX800050A-008	LTE-A Pro Framework For RTD
MX800050A-009	LTE MIMO Framework For RTD
MX800050A-010	LTE Unlicensed Framework For RTD
MX800050A-011	LTE/UTRAN/GERAN Fading Library For RTD
MX800050A-012	5G Fading Library
MX800050A-013	5G SA Framework For RTD
MX800050A-020	5G NR Advanced Framework For RTD
MX800050A-021	5G NE-DC Framework For RTD
MX800050A-025	5G R17 RedCap Framework For RTD
MX800050A-026	5G R17 Small Data Transmission For RTD
MX800050A-032	4G ePDG WiFi
MX800050A-040	RTD Test Creation and Editing Tools
MX800050A-041	RTD Test Execution Tools
MX800050A-042	RTD Protocol Analyzer
MX800050A-051	RTD Floating (Server Based) License
MX800050A-052	Modem Log Converter For Qualcomm
MX800050A-055	SMIT Advanced Features
MX800050A-070	NTN over IoT Framework For RTD

Model/Order No.	Name
MX800060A	Control Software
MX800060A-001	NSA Framework For L1/L2 Testing
MX800060A-013	SA Framework For L1/L2 Testing
MX800070A	SmartStudio NR
MX800070A-001	5G NSA Option
MX800070A-002	5G SA Option
MX800070A-003	LTE Core Option
MX800070A-004	5G Core Option
MX800070A-007	LTE Control for MT8000A
MX800070A-011	NR TDD Option
MX800070A-012	NR FDD Option
MX800070A-013	SDAP Option
MX800070A-014	NR FR1+FR2 Inter-working Option
MX800070A-030	NR DL 2×2 MIMO BW 100 MHz Per Cell
MX800070A-035	NR DL 4×4 MIMO BW 100 MHz Per Cell
MX800070A-040	NR UL 2×2 MIMO BW 100 MHz Per Cell
MX800070A-050	NR DL 2CA Option
MX800070A-051	NR DL 3CA Option
MX800070A-052	NR DL 4CA Option
MX800070A-053	NR DL 6CA Extension Option
MX800070A-054	NR DL 8CA Extension Option
MX800070A-060	NR UL 2CA Option
MX800070A-061	NR UL 3CA Option
MX800070A-062	NR UL 4CA Option
MX800070A-063	NR UL 5CA Option
MX800070A-070	LTE DL 2×2 MIMO Option
MX800070A-071	LTE DL 4×4 MIMO Option
MX800070A-072	LTE LAA Option
MX800070A-073	LTE 2CA Option
MX800070A-074	LTE 3CA Option
MX800070A-080	IMS Server Option
MX800070A-081	IMS Script Option
MX800070A-082	RTP Control Option
MX800070A-083	IMS Log Import Option
MX800070A-090	NR Neighbour Cell List
MX800071A	SmartStudio NR IP Performance
MX800071A-001	5G NSA Option
MX800071A-002	5G SA Option
MX800071A-003	LTE Core Option
MX800071A-004	5G Core Option
MX800071A-007	LTE Control for MT8000A
MX800071A-011	NR TDD Option
MX800071A-012	NR FDD Option
MX800071A-030	NR DL 2×2 MIMO BW 100 MHz Per Cell
MX800071A-035	NR DL 4×4 MIMO BW 100 MHz Per Cell
MX800071A-040	NR UL 2×2 MIMO BW 100 MHz Per Cell
MX800071A-050	NR DL 2CA Option
MX800071A-051	NR DL 3CA Option
MX800071A-052	NR DL 4CA Option
MX800071A-060	NR UL 2CA Option
MX800071A-070	LTE DL 2×2 MIMO Option
MX800071A-071	LTE DL 4×4 MIMO Option
MX800071A-072	LTE LAA Option
MX800071A-073	LTE 2CA Option
MX800071A-074	LTE 3CA Option
MX800071A-075	LTE 4CA Option
MX800071A-076	LTE 5CA Option
MX800071A-077	LTE 6CA Option
MX800071A-078	LTE 7CA Option
MX800077A	LTE Platform Software for SmartStudio
MX800078A	LTE/NR Platform Software for SmartStudio
MX800079A	NR Platform Software for SmartStudio

Radio Communication Test Station MT8000A Ordering Information

Model/Order No.	Name
	Support Services
MX800010A-SS101	5G NR RF Measurement Support Service (Per Year)
MX800010A-SS102	5G NR RF OTA Measurement Support Service (Per Year)
MX800050A-SS100	RTD Support Service (Per Year)
MX800050A-SS101	5G NSA Support Service (Per Year)
MX800050A-SS103	LTE Support Service (Per Year)
MX800050A-SS104	UTRAN/GERAN Support Service (Per Year)
MX800050A-SS105	IMS Support Service (Per Year)
MX800050A-SS106	IoT Support Service (Per Year)
MX800050A-SS107	LTE-A Support Service (Per Year)
MX800050A-SS108	LTE-A Pro Support Service (Per Year)
MX800050A-SS109	MIMO Support Service (Per Year)
MX800050A-SS110	LTE Unlicensed Support Service (Per Year)
MX800050A-SS111	LTE/UTRAN/GERAN Fading Support Service (Per Year)
MX800050A-SS112	5G Fading Support Service
MX800050A-SS113	5G SA Support Service (Per Year)
MX800050A-SS120	5G NR Advanced Support Service (Per Year)
MX800050A-SS121	5G NE-DC Support Service (Per Year)
MX800050A-SS125	5G R17 RedCap Support Service (Per Year)
MX800050A-SS126	5G R17 Small Data Transmission Support Service (Per Year)
MX800050A-SS132	4G ePDG WiFi Support Service (Per Year)
MX800050A-SS152	Modem Log Converter For Qualcomm Support Service (Per Year)
MX800050A-SS155	SMIT Advanced Features Support Service (Per Year)
MX800050A-SS170	NTN over IoT Support Service (Per Year)
MX800060A-SS100	Control Software Support Service (Per Year)
MX800060A-SS101	NSA Framework Support Service (Per Year)
MX800060A-SS113	SA Framework Support Service (Per Year)
MX800070A-SS110	SmartStudio NR Support Service (Per Year)
MX800070A-TS181	MX800070A-081 1 Year Technical Support Service
MX800071A-SS110	SmartStudio NR IP Performance Support Service (Per Year)
	Term License
MX800030A-TL000	NR Protocol Platform Software
MX800030A-TL001	NR TDD Platform
MX800030A-TL002	NR FDD Platform
MX800030A-TL003	Ciphering
MX800030A-TL004	Internal Server
MX800030A-TL005	5G SA Protocol
MX800030A-TL006	NR SDAP
MX800030A-TL007	NR FDD/TDD Joint CA
MX800030A-TL008	NR FR1+FR2 DC Protocol
MX800030A-TL009	NR FR1+FR2 CA Protocol
MX800030A-TL010	RF/Fading Driver For Multiple box
MX800030A-TL011	Over 10 Gbps IP Throughput
MX800030A-TL014	NR UL Configured Grant Type1/2
MX800030A-TL015	NR DL Semi-Persistent Scheduling
MX800030A-TL016	NR Uplink Data Compression
MX800030A-TL017	PUSCH/PUCCH DMRS Bundling
MX800030A-TL020	NR DCI Format 0_2/1_2
MX800030A-TL021	NR Supplementary Uplink
MX800030A-TL022	SCell Dormancy
MX800030A-TL024	Paging Early Indication
MX800030A-TL025	2Step RACH
MX800030A-TL026	Cross Carrier Scheduling For DC/CA Enh.
MX800030A-TL027	Wake Up Indication For Power Saving
MX800030A-TL028	Dual Active Protocol Stack Handover For Mobility Enh.
MX800030A-TL029	NR eDRX
MX800030A-TL031	NR DL 2x2 MIMO BW 50 MHz Per Cell
MX800030A-TL032	NR DL 2x2 MIMO BW 100 MHz Per Cell
MX800030A-TL033	NR DL 2x2 MIMO BW 200 MHz Per Cell
MX800030A-TL035	NR DL 4x4 MIMO BW 50 MHz Per Cell
MX800030A-TL036	NR DL 4x4 MIMO BW 100 MHz Per Cell
MX800030A-TL041	NR UL 2x2 MIMO BW 50 MHz Per Cell
MX800030A-TL042	NR UL 2x2 MIMO BW 100 MHz Per Cell
MX800030A-TL043	NR UL 2x2 MIMO BW 200 MHz Per Cell
MX800030A-TL051	NR DL 2CA For Protocol

Model/Order No.	Name
MX800030A-TL052	NR DL 3CA For Protocol
MX800030A-TL053	NR DL 4CA For Protocol
MX800030A-TL054	NR DL 5CA For Protocol
MX800030A-TL055	NR DL 6CA For Protocol
MX800030A-TL056	NR DL 7CA For Protocol
MX800030A-TL057	NR DL 8CA For Protocol
MX800030A-TL058	NR DL 9CA For Protocol
MX800030A-TL059	NR DL 10CA For Protocol
MX800030A-TL061	NR UL 2CA For Protocol
MX800030A-TL062	NR UL 3CA For Protocol
MX800030A-TL063	NR UL 4CA For Protocol
MX800032A-TL000	LTE Protocol Platform Software
MX800032A-TL001	LTE Anchor For Protocol
MX800032A-TL002	LTE Advance Features
MX800032A-TL010	LTE RF/Fading Driver For Multiple Box
MX800037A-TL000	LTE/NR Protocol Platform Software
MX800050A-TL001	5G NSA Framework For RTD (3 months)
MX800050A-TL002	RTD LL/L3 Procedure Libraries (5G) (3 months)
MX800050A-TL003	Core LTE Framework For RTD (3 months)
MX800050A-TL004	UTRAN/GERAN Framework For RTD (3 months)
MX800050A-TL005	IMS Framework For RTD (3 months)
MX800050A-TL006	IoT Framework For RTD (3 months)
MX800050A-TL007	LTE-A Framework For RTD (3 months)
MX800050A-TL008	LTE-A Pro Framework For RTD (3 months)
MX800050A-TL009	LTE MIMO Framework For RTD (3 months)
MX800050A-TL010	LTE Unlicensed Framework For RTD (3 months)
MX800050A-TL011	LTE/UTRAN/GERAN Fading Library For RTD (3 months)
MX800050A-TL012	5G Fading Library (3 months)
MX800050A-TL013	5G SA Framework For RTD (3 months)
MX800050A-TL020	5G NR Advanced Framework For RTD (3 months)
MX800050A-TL021	5G NE-DC Framework For RTD (3 months)
MX800050A-TL025	5G R17 RedCap Framework For RTD (3 months)
MX800050A-TL026	5G R17 Small Data Transmission For RTD (3 months)
MX800050A-TL032	4G ePDG WiFi (3 months)
MX800050A-TL040	RTD Test Creation and Editing Tools (3 months)
MX800050A-TL041	RTD Test Execution Tools (3 months)
MX800050A-TL042	RTD Protocol Analyser (3 months)
MX800050A-TL052	Modem Log Converter For Qualcomm (3 months)
MX800050A-TL055	SMIT Advanced Features (3 months)
MX800050A-SS000	RTD Support Service (3 months)
MX800050A-SS001	5G NSA Support Service (3 months)
MX800050A-SS003	LTE Support Service (3 months)
MX800050A-SS004	UTRAN/GERAN Support Service (3 months)
MX800050A-SS005	IMS Support Service (3 months)
MX800050A-SS006	IoT Support Service (3 months)
MX800050A-SS007	LTE-A Support Service (3 months)
MX800050A-SS008	LTE-A Pro Support Service (3 months)
MX800050A-SS009	MIMO Support Service (3 months)
MX800050A-SS010	LTE Unlicensed Support Service (3 months)
MX800050A-SS011	LTE/UTRAN/GERAN Fading Support Service (3 months)
MX800050A-SS012	5G Fading Library Support Service (3 months)
MX800050A-SS013	5G SA Support Service (3 months)
MX800050A-SS020	5G NR Advanced Support Service (3 months)
MX800050A-SS021	5G NE-DC Support Service (3 months)
MX800050A-SS025	5G R17 RedCap Support Service (3 months)
MX800050A-SS026	5G R17 Small Data Transmission Support Service (3 months)
MX800050A-SS032	4G ePDG WiFi Support Service (3 months)
MX800050A-SS052	Modem Log Converter For Qualcomm Support Service (3 months)
MX800050A-SS055	SMIT Advanced Features Support Service (3 months)

Radio Communication Test Station MT8000A Ordering Information

Model/Order No.	Name
Warranty Services	
MT8000A-ES210	2 Years Extended Warranty Service
MT8000A-ES310	3 Years Extended Warranty Service
MT8000A-ES510	5 Years Extended Warranty Service
MA80001A-ES210	2 Years Extended Warranty Service
MA80001A-ES310	3 Years Extended Warranty Service
MA80001A-ES510	5 Years Extended Warranty Service
MA80002A-ES210	2 Years Extended Warranty Service
MA80002A-ES310	3 Years Extended Warranty Service
MA80002A-ES510	5 Years Extended Warranty Service
MA80003A-ES210	2 Years Extended Warranty Service
MA80003A-ES310	3 Years Extended Warranty Service
MA80003A-ES510	5 Years Extended Warranty Service

Related Products



Radio Communication Analyzer
MT8821C



Signalling Tester
MD8430A



Signalling Tester
MD8475B



Shield Box
MA8161A



RF Chamber
MA8171A



CATR Anechoic Chamber
MA8172A



Butler Matrix 8x8
(0.6 GHz-7.125 GHz)
MA8118A



Butler Matrix 4x4
(0.6 GHz-7.125 GHz)
MA8114A

Note:



+1 (888) 880-6804
sales@testforce.com

Anritsu Advancing beyond

Specifications are subject to change without notice.

• United States

Anritsu Americas Sales Company
490 Jarvis Drive, Morgan Hill, CA 95037-2809, U.S.A.
Phone: +1-800-Anritsu (1-800-267-4878)

• Canada

**Anritsu Electronics Ltd.
Americas Sales and Support**
490 Jarvis Drive, Morgan Hill, CA 95037-2809, U.S.A.
Phone: +1-800-Anritsu (1-800-267-4878)

• Brazil

Anritsu Eletronica Ltda.
Praça Amadeu Amaral, 27 - 1 Andar
01327-010 - Bela Vista - Sao Paulo - SP, Brazil
Phone: +55-11-3283-2511
Fax: +55-11-3288-6940

• Mexico

Anritsu Company, S.A. de C.V.
Blvd Miguel de Cervantes Saavedra #169 Piso 1, Col. Granada
Mexico, Ciudad de Mexico, 11520, MEXICO
Phone: +52-55-4169-7104

• United Kingdom

Anritsu EMEA Ltd.
200 Capability Green, Luton, Bedfordshire, LU1 3LU, U.K.
Phone: +44-1582-433200
Fax: +44-1582-731303

• France

Anritsu S.A.
12 avenue du Québec, Immeuble Goyave,
91140 VILLEBON SUR YVETTE, France
Phone: +33-1-60-92-15-50

• Germany

Anritsu GmbH
Nemetschek Haus, Konrad-Zuse-Platz 1,
81829 München, Germany
Phone: +49-89-442308-0
Fax: +49-89-442308-55

• Italy

Anritsu S.r.l.
Spaces Eur Arte, Viale dell'Arte 25, 00144 Roma, Italy
Phone: +39-6-509-9711

• Sweden

Anritsu AB
Kistagången 20 B, 2 tr, 164 40 Kista, Sweden
Phone: +46-8-534-707-00

• Finland

Anritsu A/S
Technopolis Aviapolis, Teknobulevardi 3-5 (D208.5),
FI-01530 Vantaa, Finland
Phone: +358-20-741-8100

• Denmark

Anritsu A/S
c/o Regus Winghouse, Ørestads Boulevard 73, 4th floor,
2300 Copenhagen S, Denmark
Phone: +45-7211-2200

• Spain

**Anritsu EMEA GmbH
Representation Office in Spain**
Calle Manzanares 4, Primera planta, 28005 Madrid, Spain
Phone: +34-91-572-6761

• Austria

Anritsu EMEA GmbH
Am Belvedere 10, A-1100 Vienna, Austria
Phone: +43-(0)1-717-28-710

• United Arab Emirates

Anritsu A/S
Office No. 164, Building 17, Dubai Internet City
P. O. Box – 501901, Dubai, United Arab Emirates
Phone: +971-4-3758479

• India

Anritsu India Private Limited
6th Floor, Indiqube ETA, No.38/4, Adjacent to EMC2,
Doddanekundi, Outer Ring Road, Bengaluru – 560048, India
Phone: +91-80-6728-1300
Fax: +91-80-6728-1301

• Singapore

Anritsu Pte. Ltd.
1 Jalan Kilang Timor, #07-04/06 Pacific Tech Centre
Singapore 159303
Phone: +65-6282-2400
Fax: +65-6282-2533

• Vietnam

Anritsu Company Limited
16th Floor, Peakview Tower, 36 Hoang Cau Street, O Cho Dua Ward,
Dong Da District, Hanoi, Vietnam
Phone: +84-24-3201-2730

• P.R. China (Shanghai)

Anritsu (China) Co., Ltd.
Room 2701-2705, Tower A, New Caohejing International
Business Center No. 391 Gui Ping Road Shanghai, 200233, P.R. China
Phone: +86-21-6237-0898
Fax: +86-21-6237-0899

• P.R. China (Hong Kong)

Anritsu Company Ltd.
Unit 1006-7, 10/F., Greenfield Tower, Concordia Plaza,
No. 1 Science Museum Road, Tsim Sha Tsui East,
Kowloon, Hong Kong, P.R. China
Phone: +852-2301-4980
Fax: +852-2301-3545

• Japan

Anritsu Corporation
8-5, Tamura-cho, Atsugi-shi, Kanagawa, 243-0016 Japan
Phone: +81-46-296-6509
Fax: +81-46-225-8352

• Korea

Anritsu Corporation, Ltd.
8F, A TOWER, 20, Gwacheondaero 7-gil, Gwacheon-si,
Gyeonggi-do, 13840, Republic of Korea
Phone: +82-2-6259-7300
Fax: +82-2-6259-7301

• Australia

Anritsu Pty. Ltd.
Unit 20, 21-35 Ricketts Road, Mount Waverley, Victoria 3149, Australia
Phone: +61-3-9558-8177
Fax: +61-3-9558-8255

• Taiwan

Anritsu Company Inc.
7F, No. 316, Sec. 1, NeiHu Rd., Taipei 114, Taiwan
Phone: +886-2-8751-1816
Fax: +886-2-8751-1817