

Anritsu Advancing beyond

LMR Master™

Land Mobile Radio Modulation and Signal Analyzer,
Vector Network Analyzer, and Spectrum Analyzer

S412E

9 kHz to 1.6 GHz Spectrum Analyzer

500 kHz to 1.6 GHz Vector Network Analyzer



Introduction

The S412E is Anritsu's second generation solution for installing and maintaining public safety systems. Built on Anritsu's ninth generation handheld platform, the S412E combines a high performance receiver/spectrum analyzer with the world's most advanced handheld vector network analyzer plus a powerful vector signal generator with internally adjustable power from 0 dBm to -130 dBm.

Land Mobile Radio Signal Analyzer Highlights

- Analyzes Narrowband FM analog systems
- Analyzes P25 (TIA-102.CAAA-C), P25 Phase 2 (TIA-102.CCAA), DMR (MOTOTRBO™)^a, NXDN™, dPMR, PTC-ITCR, PTC-ACSES, and TETRA digital systems
- 100 kHz to 1.6 GHz frequency coverage (Optional extension to 6 GHz)
- Internal signal generator: 0.1 dB resolution, 0 dBm to -130 dBm (spec to -120 dBm)
- 2.0 dB signal generator accuracy (typical)
- P25/P25p2, NXDN, and ETSI DMR BER test patterns including 1011, 1031, and V.52/O.153
- Duplex test: Simultaneous analysis and generation of analog or digital LMR signals
- Independent control of both receive/transmit frequencies and test patterns
- TETRA Base Station Receiver Sensitivity Measurements

a.Supports those features compliant with the ETSI DMR standard.

Spectrum Analyzer Highlights

- Measurements: Occupied Bandwidth, Channel Power, ACPR, C/I, Coverage Mapping
- Interference Analyzer: Spectrogram, Signal Strength, RSSI, Mapping
- 9 kHz to 1.6 GHz frequency coverage (Optional extension to 6 GHz)
- Dynamic Range: > 95 dB in 10 Hz RBW
- DANL: -152 dBm in 10 Hz RBW
- Phase Noise: -100 dBc/Hz max @ 10 kHz offset at 1 GHz
- Frequency Accuracy: $\pm 1.2 \times 10^{-7}$ +aging; $< \pm 5.0 \times 10^{-8}$ with GPS on, 3 minutes after satellite is locked in selected mode
- PIM Hunting

VNA Analyzer Highlights

- 1-path, 2-port Vector Network Analyzer (VNA) w/ quad trace display
- 500 kHz to 1.6 GHz frequency coverage (Optional extension to 6 GHz)
- Intuitive Graphical User Interface (GUI) with convenient touchscreen
- VNA-quality error correction for directivity and source match
- Outstanding calibration stability, up to 16 hours
- Arbitrary data points up to 4001
- IF Bandwidth selections of 10 Hz to 100 kHz
- 100 dB transmission dynamic range
- 850 μ s/data point sweep speed

Signal Generator Highlights

- 500 kHz to 1.6 GHz CW/FM/AM Modulation
- FM, 100 Hz to 10 kHz rate, adjustable deviation
- AM, 100 Hz to 10 kHz rate, adjustable depth
- 0.1 dB resolution, 0 dBm to -130 dBm
- CW, FM with CTCSS/DCS/DTMF, FM with CTCSS/DCS/DTMF + Tone Modulation, FM + Tone Modulation

Capabilities and Functional Highlights

- Analog FM and digital LMR analyzer
- High accuracy internal power meter
- On-screen LMR Coverage Mapping (Outdoor and Indoor)
- GPS tagging of saved traces
- USB data transfer
- Complies with MIL-PRF-28800F Class 2 and MIL-STD-810G
- Certified for use in Explosive Atmosphere per MIL-PRF-28800F 8.4 inch daylight-viewable TFT LCD color resistive touchscreen – allows use while wearing gloves
- Touchscreen keyboard
- USB and Ethernet data transfer
- Web Remote Control
- Master Software Tools™
- 3 hour battery operation time



LMR Master™ S412E featuring 8.4 inch Daylight Viewable Touchscreen
 Compact Size: 273 mm x 199 mm x 91 mm, (10.7 in x 7.8 in x 3.6 in),
 Lightweight: 3.6 kg, (7.9 lb)

Table of Contents

Spectrum Analyzer4

Vector Network Analyzer6

Interference Analyzer (Option 25).....11

Channel Scanner (Option 27).....11

GPS Receiver (Option 31)11

Ethernet Connectivity11

Coverage Mapping (Option 431).....12

Electromagnetic Field Test (Option 444)12

CW Signal Generator.....12

Internal Power Meter13

High Accuracy Power Meter (Option 19)13

NBFM Analyzer and Coverage Mapping14

P25/P25p2 Analyzer and P25/P25p2 Talk-Out Coverage (Options 521 and 522)15

P25/P25p2 Signal Generator16

DMR (MOTOTRBO) Analyzer and DMR Talk-Out Coverage (Options 591 and 592).....17

dPMR Analyzer (Options 573 and 572).....18

NXDN Analyzer and NXDN Talk-Out Coverage (Options 531 and 532).....19

TETRA Analyzer and TETRA Coverage Mapping (Options 581 and 582)20

TETRA Signal Generator20

PTC-ITCR Analyzer and PTC-ITCR Talk-Out Coverage (Options 721 and 722)21

PTC-ACES Analyzer and PTC ACSES Talk-Out Coverage (Options 731 and 733).....22

AM/FM/PM Signal Analyzers (Option 509).....23

LTE Signal Analyzers (Options 541, 542, 546, and 886)24

TDD LTE Signal Analyzers (Options 551, 552, and 556)25

GSM/GPRS/EDGE Measurements (Option 880).....26

IEEE 802.16 Fixed WiMAX Signal Analyzers (Options 46 and 47)27

IEEE 802.16 Mobile WiMAX Signal Analyzers (Options 66, 67, and 37)28

General Specifications29

Master Software Tools31

easyTest Tools™.....31

Line Sweep Tools.....32

Web Remote Control.....32

Programmable Remote Control32

Ordering Information – Options33

Standard Accessories34

USB Power Sensors34

Optional Accessories.....35

Manuals, Related Literature.....43

Troubleshooting Guides.....43

Definitions

All specifications and characteristics apply to Revision 4 instruments under the following conditions, unless otherwise noted:

Warm-Up Time	After 15 minutes of warm-up time in VNA mode, where the instrument is left in the ON state.
Temperature Range	Over the 23 °C ± 5 °C temperature range, unless otherwise noted.
Reference Signal	When using internal reference signal.
Typical Performance	Typical specifications that are not in parenthesis are not tested and not warranted. They are generally representative of characteristic performance. Typical specifications in parenthesis () represent the mean value of measured units and do not include any guard-bands or uncertainties. They are not warranted.
Uncertainty	A coverage factor of x1 is applied to the measurement uncertainties to facilitate comparison with other industry handheld analyzers.
Calibration Cycle	Calibration is within the recommended 12 month period (residual specifications also require calibration kit calibration cycle adherence.)

All specifications subject to change without notice. For the most current data sheet, please visit the Anritsu web site: www.anritsu.com



Spectrum Analyzer

Measurements

Smart Measurements	Field Strength (uses antenna calibration tables to measure dBm/m ² or dBmV/m) Occupied Bandwidth (measures 99% to 1% power channel of a signal) Channel Power (measures the total power in a specified bandwidth) ACPR (Adjacent Channel Power Ratio) AM/FM/SSB Audio Demodulation (Wide/Narrow FM, AM, Upper/Lower SSB) C/I (carrier-to-interference ratio) Emission Mask Coverage Mapping (requires option 431) PIM Alert Application (available for download) PIM Hunting
--------------------	--

Setup Parameters

Frequency	Center/Start/Stop, Span, Frequency Step, Signal Standard, Channel #, Channel Increment
Amplitude	Reference Level (RL), Scale, Attenuation Auto/Level, RL Offset, Preamp On/Off, Detection
Span	Span, Span Up/Down (1-2-5), Full Span, Zero Span, Last Span
Bandwidth	RBW, Auto RBW, VBW, Auto VBW, RBW/VBW, Span/RBW
File	Save, Save-on-Event, Recall, Copy, Delete
Save	Setups, Measurements, Screen Shots (JPEG), Limit Lines, Spurious Emission Mask
Save-on-Event	Crossing Limit Line, Sweep Complete, Save-then-Stop, Clear All
Recall	Setups, Measurements, Limit Lines, Spurious Emission Mask
Copy	Selected file or files to internal/external memory (USB)
Delete	Selected file or files from internal/external memory (USB)
Application Options	Bias-Tee On/Off, Impedance (50 Ω, 75 Ω, Other)

Sweep Functions

Sweep	Single/Continuous, Manual Trigger, Reset, Detection, Minimum Sweep Time, Trigger Type
Detection	Peak, RMS, Negative, Sample, Quasi-peak
Triggers	Free Run, External, Video, Change Position, Manual

Trace Functions

Traces	Up to three Traces (A, B, C), View/Blank, Write/Hold, Trace A/B/C Operations
Trace A Operations	Normal, Max Hold, Min Hold, Average, # of Averages, (always the live trace)
Trace B Operations	A → B, B ↔ C, Max Hold, Min Hold
Trace C Operations	A → C, B ↔ C, Max Hold, Min Hold, A - B → C, B - A → C, Relative Reference (dB), Scale

Marker Functions

Markers	Markers 1-6 each with a Delta Marker, or Marker 1 Reference with Six Delta Markers, Marker Table On/Off, All Markers Off
Marker Types	Style (Fixed/Tracking), Noise Marker, Frequency Counter Marker, Marker Auto-Position Peak Search, Next Peak (Right/Left), Peak Threshold %, Set Marker to Channel, Marker Frequency to Center, Delta Marker to Span, Marker to Reference Level
Marker Table	1-6 markers frequency and amplitude plus delta markers frequency offset and amplitude

Limit Line Functions

Limit Lines	Upper/Lower, On/Off, Edit, Move, Envelope, Advanced, Limit Alarm, Default Limit
Limit Line Edit	Frequency, Amplitude, Add Point, Add Vertical, Delete Point, Next Point Left/Right
Limit Line Move	To Current Center Frequency, By dB or Hz, To Marker 1, Offset from Marker 1
Limit Line Envelope	Create Envelope, Update Amplitude, Points (41 max), Offset, Shape Square/Slope
Limit Line Advanced	Type (Absolute/Relative), Mirror, Save/Recall

 **Spectrum Analyzer Performance**

Frequency

Frequency Range	9 kHz to 1.6 GHz, (6 GHz with Option 6)
Tuning Resolution	1 Hz
Frequency Reference Aging	$\pm 1.0 \times 10^{-6}$ per year
Frequency Reference Accuracy	$\pm 1.2 \times 10^{-7}$ ($\pm 25^\circ\text{C}$) + aging, standard $< \pm 5.0 \times 10^{-8}$ with GPS on, 3 minutes after satellite is locked in selected mode
Frequency Span	10 Hz to 1.6 GHz including zero span (10 Hz to 6 GHz with Option 6)
Sweep Time	100 ms min, 7 μs to 3600 seconds in zero span
Sweep Time Accuracy	$\pm 2\%$ in zero span

Bandwidth

Resolution Bandwidth (RBW)	10 Hz to 3 MHz in 1-3 sequence $\pm 10\%$ (1 MHz max in zero span) (-3 dB bandwidth)
Video Bandwidth (VBW)	1 Hz to 3 MHz in 1-3 sequence (-3 dB bandwidth) (auto or manually selectable)
RBW with Quasi-Peak Detection	200 Hz, 9 kHz, 120 kHz (-6 dB bandwidth)
VBW with Quasi-Peak Detection	Auto VBW is On, RBW/VBW = 1

Spectral Purity

SSB Phase Noise @ 1 GHz	-100 dBc/Hz, -110 dBc/Hz typical @ 10 kHz offset -105 dBc/Hz, -112 dBc/Hz typical @ 100 kHz offset -115 dBc/Hz, -121 dBc/Hz typical @ 1 MHz offset
-------------------------	--

Amplitude Ranges

Dynamic Range	> 95 dB (2.4 GHz), 2/3 (TOI-DANL) in 10 Hz RBW
Measurement Range	DANL to +26 dBm (≥ 50 MHz) DANL to 0 dBm (< 50 MHz)
RF In Port Damage Level	+33 dBm peak, ± 50 VDC, Maximum Continuous Input (≥ 10 dB attenuation)
Display Range	1 to 15 dB/div in 1 dB steps, ten divisions displayed
Reference Level Range	-150 dBm to +30 dBm
Attenuator Resolution	0 to 55 dB, 5.0 dB steps
Amplitude Units	Log Scale Modes: dBW, dBm, dB μ W, dBV, dBmV, dB μ V, dBA, dBmA, dB μ A Linear Scale Modes: nV, μ V, mV, V, nW, μ W, mW, W, nA, μ A, mA, A

Amplitude Accuracy

(Single sine wave, input power < Ref level and > DANL, Attenuation: Auto, Ambient: -10 °C to 50 °C after 30 minute warm-up)

9 kHz to 100 kHz	± 2.0 dB typical (Preamp Off)
> 100 kHz to 4.0 GHz	± 1.25 dB, ± 0.5 dB typical
> 4.0 GHz to 6 GHz	± 1.50 dB, ± 0.5 dB typical

Displayed Average Noise Level (DANL)

	Preamp Off (Reference Level -20 dBm)		Preamp On (Reference Level -50 dBm)	
	Maximum	Typical	Maximum	Typical
(RBW = 1 Hz, 0 dB attenuation)				
10 MHz to 2.4 GHz	-141 dBm	-146 dBm	-157 dBm	-162 dBm
> 2.4 GHz to 4 GHz	-137 dBm	-141 dBm	-154 dBm	-159 dBm
> 4 GHz to 5 GHz	-134 dBm	-138 dBm	-150 dBm	-155 dBm
> 5 GHz to 6 GHz	-126 dBm	-131 dBm	-143 dBm	-150 dBm
(RBW = 10 Hz, 0 dB attenuation)				
10 MHz to 2.4 GHz	-131 dBm	-136 dBm	-147 dBm	-152 dBm
> 2.4 GHz to 4 GHz	-127 dBm	-131 dBm	-144 dBm	-149 dBm
> 4 GHz to 5 GHz	-124 dBm	-128 dBm	-140 dBm	-145 dBm
> 5 GHz to 6 GHz	-116 dBm	-121 dBm	-133 dBm	-140 dBm

Spurs

Residual Spurious	< -90 dBm (RF input terminated, 0 dB input attenuation, > 10 MHz)
Input-Related Spurious	< -75 dBc (0 dB attenuation, -30 dBm input, span < 1.7 GHz, carrier offset > 4.5 MHz)
Exceptions, typical	< -70 dBc @ < 2.5 GHz with 2072.5 MHz Input < -68 dBc @ F1 - 280 MHz with F1 Input < -70 dBc @ F1 + 190.5 MHz with F1 Input < -52 dBc @ 7349 - 2F2 MHz with F2 Input, where F2 < 2437.5 MHz < -52 dBc @ 190.5 \pm 0.5F1/2 MHz with F1 < 1 GHz and equal to input frequency and center frequency

Third-Order Intercept (TOI) (Preamp Off, -20 dBm tones, 100 kHz apart, 10 dB attenuation)

800 MHz	+16 dBm
2400 MHz	+20 dBm
200 MHz to 2200 MHz	+25 dBm typical
> 2.2 GHz to 5.0 GHz	+28 dBm typical
> 5.0 GHz to 6.0 GHz	+33 dBm typical

Second Harmonic Distortion (Preamp Off, 0 dB input attenuation, -30 dBm input)

50 MHz	-56 dBc
> 50 MHz to 200 MHz	-60 dBc typical
> 200 MHz to 3000 MHz	-70 dBc typical

VSWR

2:1 typical

 **Vector Network Analyzer**

Block Diagram

As shown in the following simplified block diagram, the LMR Master has a 2-port, 1-path architecture that automatically measures two S-parameters with error-correction precision inherent to VNA operation. The magnitude and phase information gained from vector network data enables the LMR Master to make significant error corrections and provide improved field measurements.

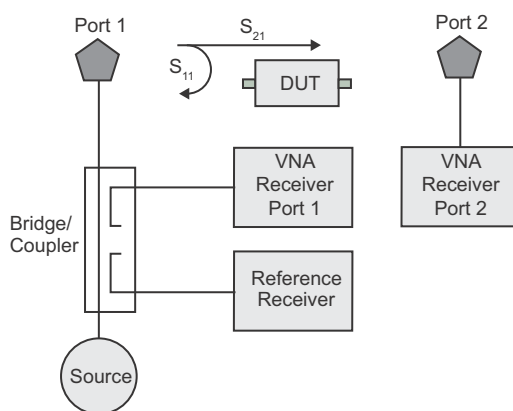

Frequency

Frequency Range	500 kHz to 1.6 GHz (500 kHz to 6.0 GHz with Option 16)
Frequency Accuracy	2.5 ppm
Frequency Resolution	1 Hz

Test Port Power (Typical)

LMR Master supports selection of High, Default, or Low test port power. Changing power after calibration can degrade the calibrated performance. Typical test port power by bands is shown in the following table.

Frequency Range	High Port Power	Default Port Power	Low Port Power
500 kHz to ≤ 3 GHz	+3 dBm	-5 dBm	-25 dBm
3 GHz to ≤ 6 GHz	0 dBm	-5 dBm	-25 dBm

Transmission Dynamic Range

The transmission dynamic range (the difference between test port power and noise floor) using 10 Hz IF Bandwidth and High Port Power:

2 MHz to ≤ 4 GHz	100 dB
4 GHz to ≤ 6 GHz	90 dB

Sweep Speed (Typical)

The two-receiver architecture will simultaneously collect S_{21} and S_{11} in a single sweep. The typical sweep speed for IF Bandwidth of 100 Hz, 1001 data points, and single display is:

Frequency Range	500 kHz to 6 GHz
Typical Sweep Speed	850 μ s / point

Noise Floor (Typical)

Frequency Range	Typical Noise Floor
500 kHz to 3 GHz	-100 dBm
3 GHz to 4 GHz	-103 dBm
4 GHz to 6 GHz	-93 dBm

Temperature Stability (S11 or S21, Short, 23 °C ± 5 °C)

Frequency Range	Magnitude (Typical)	Phase (Typical)
500 kHz to 6 GHz	0.020 dB/°C	0.200 deg/°C

Interference Immunity

On-Channel	+17 dBm at > 1.0 MHz from carrier frequency
On-Frequency	0 dBm within ± 10 kHz of the carrier frequency



Vector Network Analyzer (Continued)

Measurements

Measurement Parameters	S_{11} , S_{21}
Number of Traces	Four: TR1, TR2, TR3, TR4
Trace Format	Single, Dual, Tri, Quad. When used with Number of Traces, overlays are possible including a Single Format with Four trace overlays.
Graph Types	Log Magnitude, SWR, Phase, Real, Imaginary, Group Delay, Smith Chart, Log Mag/2 (1-Port Cable Loss), Linear Polar, Log Polar, Real Impedance, Imaginary Impedance
Domains	Frequency Domain, Distance Domain
Frequency	Start Frequency, Stop Frequency, Center Frequency, Span
Distance	Start Distance, Stop Distance
Frequency Sweep Type: Linear	Single Sweep, Continuous
Data Points	2 to 4001 (arbitrary setting); data points can be reduced without recalibration.
Limit Lines	Upper, Lower, 10 segmented Upper, 10 segmented Lower
Test Limits	Pass/Fail for Upper, Pass/Fail for Lower, Limit Audible Alarm
Data Averaging	Sweep-by-sweep
Smoothing	0 to 20 %
IF Bandwidth	10, 20, 50, 100, 200, 500, 1 k, 2 k, 5 k, 10 k, 20 k, 50 k, 100 k (Hz)
Reference Plane	The reference planes of a calibration (or other normalization) can be changed by entering a line length. Assumes no loss, flat magnitude, linear phase, and constant impedance.
Auto Reference Plane Extension	Instead of manually entering a line length, this feature automatically adjusts phase shift from the current calibration (or other normalization) to compensate for external cables (or test fixtures). Assumes no loss, flat magnitude, linear phase, and constant impedance.
Frequency Range	Frequency range of the measurement can be narrowed (reduces number of data points) within the calibration range without recalibration. When Interpolation is On, narrowed frequency range will retain original number of data points.
Group Delay Aperture	Defined as the frequency span over which the phase change is computed at a given frequency point. The aperture can be changed without recalibration. The minimum aperture is the frequency range divided by the number of points in calibration and can be increased to 20% of the frequency range.
Group Delay Range	< 180° of phase change within the aperture
Trace Memory	A separate memory for each trace can be used to store measurement data for later display. The trace data can be saved and recalled.
Trace Math	Complex trace math operations of subtraction, addition, multiplication, or division are provided.
Number of Markers	12, arbitrary assignments to any trace
Marker Types	Reference, Delta
Marker Readout Styles	Log Mag, Cable Loss (Log Mag/2), Log Mag and Phase, Phase, Real and Imaginary, SWR, Impedance, Admittance, Normalized Impedance, Normalized Admittance, Polar Impedance, and Group Delay
Marker Search	Peak Search, Valley Search, Find Marker Value
Calibration Type	Full S_{11} , 1-Path, 2-Port (S_{11} and S_{21}), Response S_{11} , Response S_{21}
Calibration Methods	Short-Open-Load-Through (SOLT)
Calibration Standards' Coefficients	Coax: N-Connector, K-Connector, 7/16, TNC, SMA, and four User Defined
Cal Correction Toggle	On/Off
Interpolation	On/Off (Interpolation may be activated before or after calibration)
Impedance Conversion (Smith Chart)	Support for 50 Ω and 75 Ω are provided.
Units	Meters, Feet
Bias Tee Settings	Internal, Off
Timebase Reference	Internal
File Storage Types	Measurement, Setup (with CAL), Setup (without CAL), S2P (Real/Imag), S2P (Lin Mag/Phase), S2P (Log Mag/Phase), JPEG
Languages	English, French, German, Spanish, Chinese, Japanese, Korean, Italian, Russian, and Portuguese

 **Vector Network Analyzer** (Continued)

Corrected System Measurement Accuracy¹ — High Port Power, N-Type (OSLN50A-8 or OSLNF50A-8, TOSLN50A-8 or TOSLNF50A-8)

Frequency Range	Directivity (dB)	Source Match (dB)	Reflection Tracking (dB)	Transmission Tracking (dB)
< 20 MHz	≥ 42	≥ 30	± 0.01	± 0.01
20 MHz to < 3 GHz	≥ 42	≥ 30	± 0.05	± 0.01
3 GHz to 6 GHz	≥ 42	≥ 30	± 0.05	± 0.01

Corrected Measurement Uncertainty (Transmission from Port 1 to Port 2)

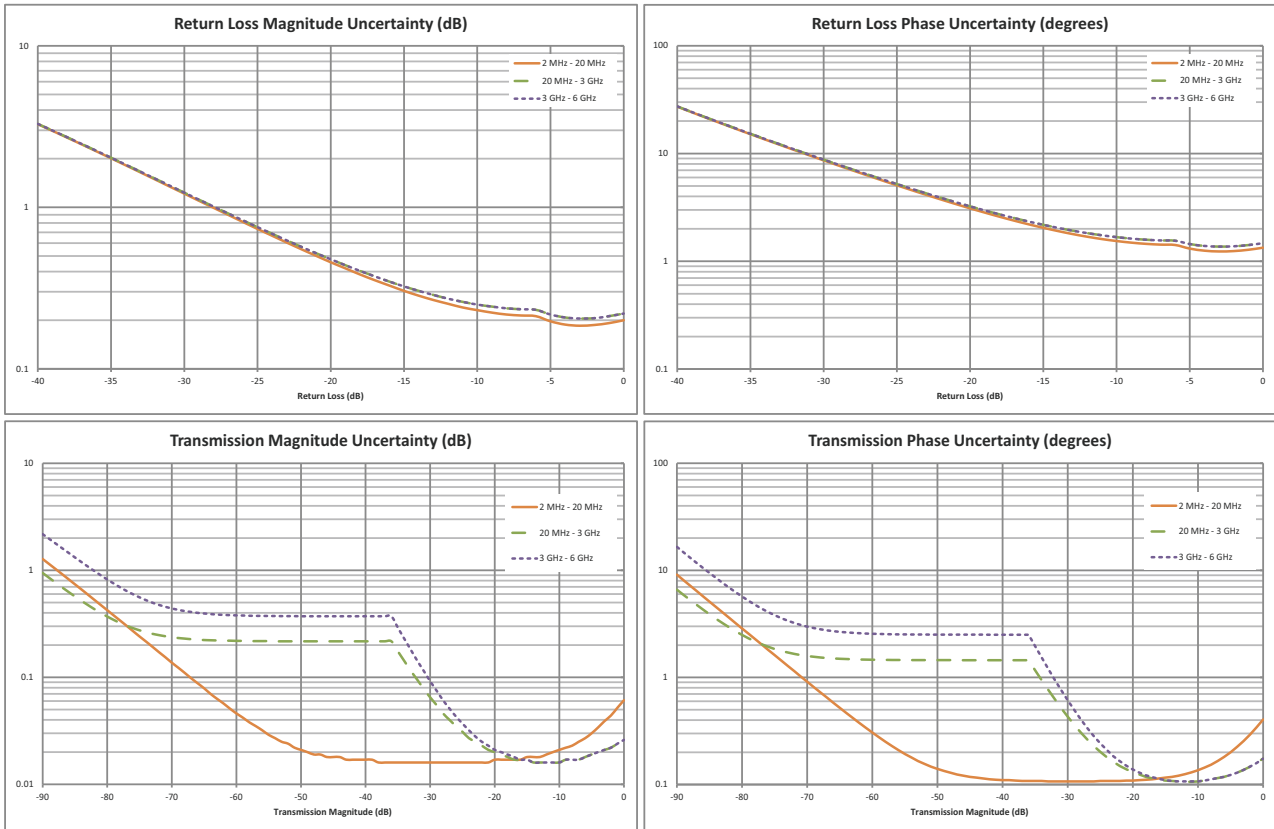

1. Full 1-path, 2-port forward path calibration with isolation, high power, 10 Hz IFBW, no averaging, 10 minute warm-up. OSLN50A-8, OSLNF50A-8, TOSLN50A-8, or TOSLNF50A-8 calibration kit. Reflection and Transmission Tracking are typical.

 **Vector Network Analyzer** (Continued)

Corrected System Measurement Accuracy¹ — High Port Power, K-Type (OSLK50A-20 or TOSLKF50A-20. Compatible with 3.5 mm and SMA connectors)

Frequency Range	Directivity (dB)	Source Match (dB)	Reflection Tracking (dB)	Transmission Tracking (dB)
< 20 MHz	≥ 42	≥ 33	± 0.01	± 0.01
20 MHz to < 3 GHz	≥ 42	≥ 33	± 0.05	± 0.01
3 GHz to 6 GHz	≥ 42	≥ 33	± 0.05	± 0.01

Corrected Measurement Uncertainty (Transmission from Port 1 to Port 2)

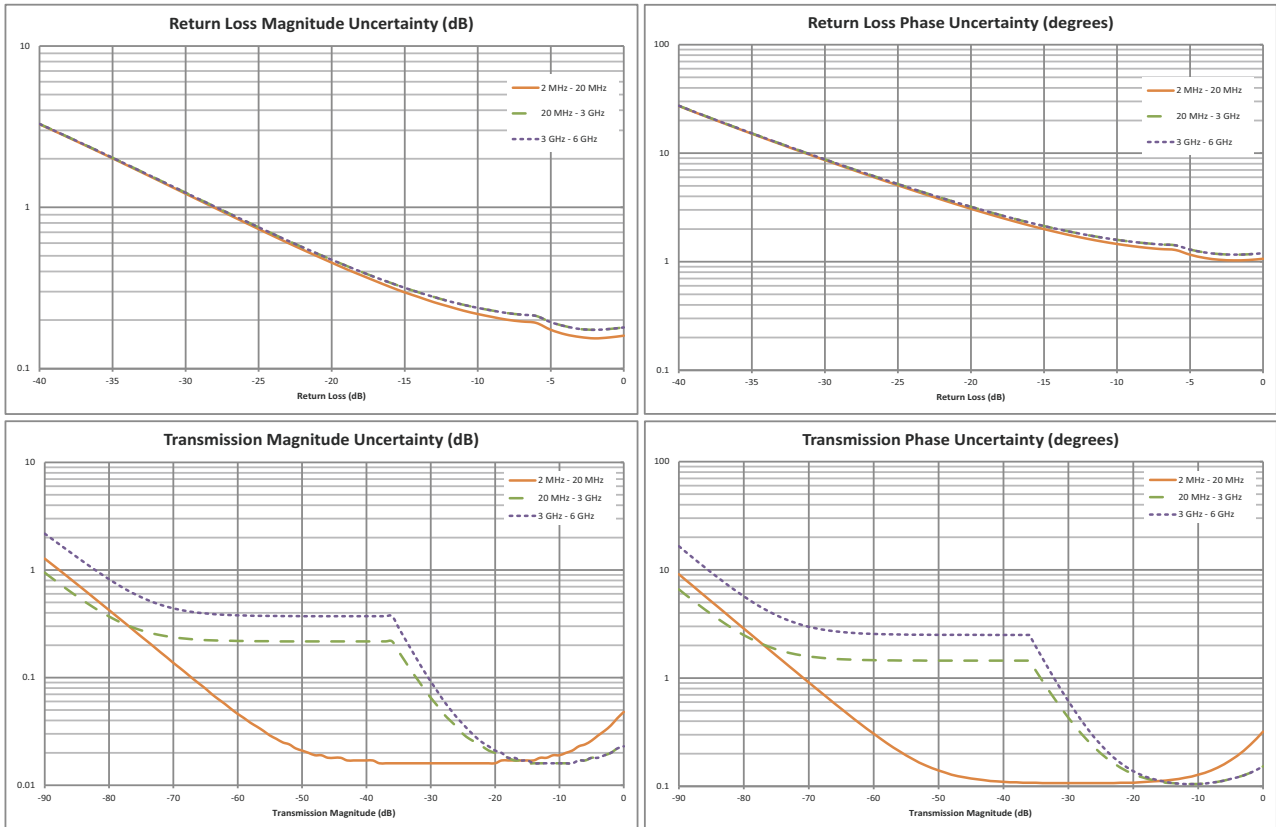

1. Full 1-path, 2-port forward path calibration with isolation, high power, 10 Hz IFBW, no averaging, 10 minute warm-up. TOSLK50A-20, TOSLKF50A-20 calibration kit. Reflection and Transmission Tracking are typical.

 **Vector Network Analyzer** (Continued)

Bias Tee (Option 10) For tower mounted amplifier tests, the S412E with optional internal bias tees can supply both DC and RF signals on the center conductor of the cable during measurements. For frequency sweeps in excess of 2 MHz, the LMR Master can supply internal voltage control from +12 to +32 V in 0.1 V steps up to 450 mA. Bias is available on VNA Port 2 and the SPA Input (RF In) for use with antenna preamplifiers.

Frequency Range	2 MHz to 4/6 GHz at VNA Port 2
Internal Voltage/Current	+12 V to +32 V at 450 mA (Steady state)
Internal Resolution	0.1 V
Bias Tee Selections	Internal, Off

The Compact LMR Master offers optional integrated bias tee for supplying DC plus RF to the DUT as shown in this simplified block diagram.

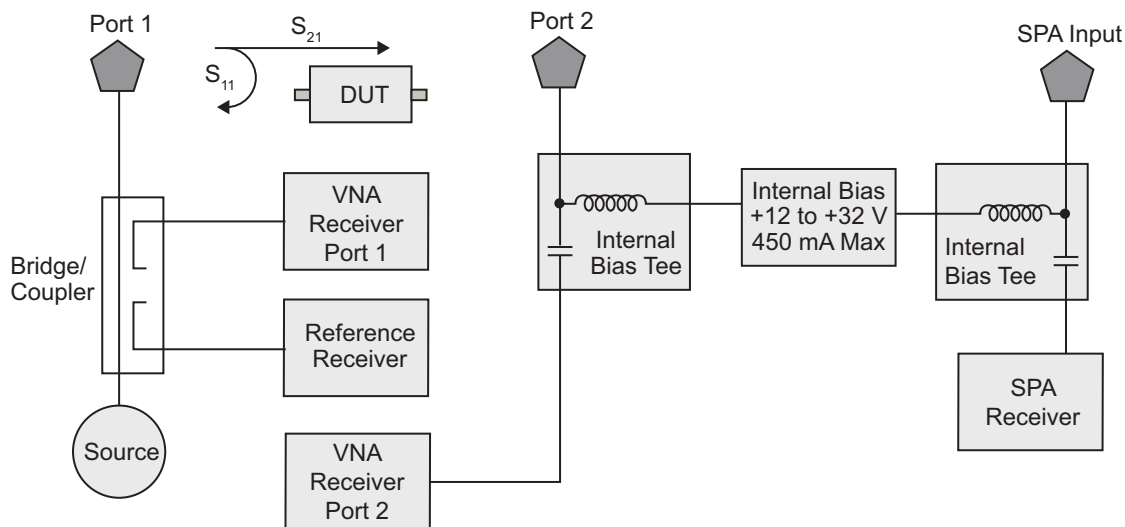

Vector Voltmeter (Option 15)

A phased array system relies on phase matched cables for nominal performance. For this class of application, the LMR Master offers this special software mode to simplify phase matching cables at a single frequency. The similarity between the popular vector voltmeter and this software mode ensures minimal training is required to phase match cables. Operation is as simple as configuring the display for absolute or relative measurements. The easy-to-read large fonts show either reflection or transmission measurements using impedance, magnitude, or VSWR readouts. For instrument landing system (ILS) or VHF Omni-directional Range (VOR) applications, a table view improves operator efficiency when phase matching up to twelve cables. The S412E solution is superior because the signal source is included internally, precluding the need for an external signal generator.

CW Frequency Range	500 kHz to 1.6 GHz (6 GHz with Option 16)
Measurement Display	CW, Table (Twelve Entries, Plus Reference)
Measurement Types	Return Loss, Insertion
Measurement Format	dB/VSWR/Impedance

Distance Domain

Distance-to-Fault Analysis is a powerful field test tool to analyze cables for faults, including minor discontinuities that may occur due to a loose connection, corrosion, or other aging effects. By using Frequency Domain Reflectometry (FDR), the VNA's DTF mode exploits a user-specified band of full power operational frequencies (instead of DC pulses from TDR approaches) to more precisely identify discontinuities. The VNA converts S-parameters from frequency domain into distance domain on the horizontal display axis, using a mathematical computation called Inverse Fourier Transform.

Connect a reflection at the opposite end of the cable and the discontinuities appear versus distance to reveal any potential maintenance issues. When access to both ends of the cable is convenient, a similar distance domain analysis is available on transmission measurements.

Distance Domain will improve your productivity with displays of the cable in terms of discontinuities versus distance. This readout can then be compared against previous measurements (from stored data) to determine whether any degradations have occurred since installation (or the last maintenance activity). More importantly, you will know precisely where to go to fix the problem and minimize or prevent downtime of the system.

Maximum Distance (4001 data points, 1.6 GHz span)	374.9 m (1,229.9 ft)
Maximum Distance (4001 data points, 6.0 GHz span)	99.9 m (327.75 ft)
Minimum Distance Resolution (1.6 GHz span)	18.7 cm (7.36 in)
Minimum Distance Resolution (6.0 GHz span)	4.99 cm (1.97 in)
Measurement Display	Return Loss, VSWR
Measurement Format	dB, VSWR



Interference Analyzer (Option 25) (GPS Option 31 recommended)

Measurements

Spectrum	Field Strength Occupied Bandwidth Channel Power Adjacent Channel Power Ratio (ACPR) AM/FM/SSB Demodulation (Wide/Narrow FM, Upper/Lower SSB - audio out only) Carrier-to-Interference ratio (C/I)
Spectrogram	Collect data up to 72 hours
Signal Strength	Gives visual and aural indication of signal strength
Signal ID	Up to 12 signals Center Frequency Bandwidth Signal Type: FM, GSM, W-CDMA, CDMA, Wi-Fi Closest Channel Number Number of Carriers
Signal-to-Noise Ratio (SNR)	> 10 dB
Interference Mapping	Triangulate location of interference with on-display maps
Application Option	Bias-Tee On/Off Impedance (50 Ω, 75 Ω, Other) Compatible with the MA2700A InterferenceHunter™ Handheld Direction Finding System



Channel Scanner (Option 27)

Number of Channels	1 to 20 Channels
Measurements	Graph/Table, Max Hold On/5 sec/Off, Freq/Channel, Current/Max, Single/Dual Color
Scanner	Scan Channels, Scan Frequencies, Scan Customer List, Scan Script Master™
Amplitude	Reference Level, Scale
Custom Scan	Signal Standard, Channel, # of Channels, Channel Step Size, Custom Scan
Frequency Accuracy	± 10 Hz + Frequency Reference
Measurement Range	-110 dBm to +26 dBm
Application Options	Bias-Tee On/Off, Impedance (50 Ω, 75 Ω, Other)

GPS Receiver (Option 31) (requires external GPS antenna, sold separately)

Setup	On/Off, Antenna Voltage 3.3/5.0 V, GPS Info
GPS Time/Location Indicator	Time, Latitude, Longitude and Altitude on display Time, Latitude, Longitude and Altitude with trace storage
GPS-Enhanced Frequency Accuracy	< 50 ppb with GPS On, 3 minutes after satellite is locked in selected mode (Applies to Spectrum Analyzer, Interference Analyzer, LMR Signal Analyzers)
Connector	SMA, Female

Ethernet Connectivity

Connector	RJ45
LAN Speed	10 Mbps
Mode	Static, DHCP
Static IP settings	IP address Subnet Mask IP Gateway
Remote Control	Remote capability provided with Web Remote Control and SCPI programming
Data Upload	With Line Sweep Tools through Ethernet connection



Coverage Mapping (Option 431)

Measurements

Indoor Mapping	RSSI, ACPR
Outdoor Mapping	RSSI, ACPR

Setup Parameters

Frequency	Center/Start/Stop, Span, Freq Step, Signal Standard, Channel #, Channel Increment
Amplitude	Reference Level (RL), Scale, Attenuation Auto/Level, RL Offset, Preamp On/Off, Detection
Span	Span, Span Up/Down (1-2-5), Full Span, Zero Span, Last Span
BW	RBW, Auto RBW, VBW, Auto VBW, RBW/VBW, Span/VBW
Measurement Setup	ACPR, RSSI
Point Distance / Time Setup	Repeat Type Time Distance
Save Points Map	Save KML, JPEG, Tab Delimited
Recall Points Map	Recall Map, Recall KML Points only, Recall KML Points with Map, Recall Default Grid



Electromagnetic Field Test (Option 444)

Measurements

Setup	Limit lines, axis dwell time, measurement time, auto-logging, measurement units, trace display
Spectrum Analyzer	Field strength is measured
LTE OTA	P-SS, S-SS, and RS are measured and displayed based on each Cell ID received
Units	Spectrum Analyzer: dBm/m ² , dBV/m, dBmV/m, dBuV/m, V/m, W/m ² , dBW/m ² , A/m, dBA/m, W/cm ² LTE OTA: dBm/m ² , V/m, W/m ²
Results	Maximum, minimum, and average of all measurements conducted
Display	Measurement status, number of measurements taken, pass/fail indicators

Frequency Range

Supported Antenna

2000-1800-R	9 kHz to 300 MHz
2000-1792-R	30 MHz to 3 GHz
2000-1791-R	700 MHz to 6 GHz

Modes where EMF Measurements Available

Spectrum Analyzer
LTE OTA (Option 546)



CW Signal Generator

Setup Parameters

Generator	On/Off
Tx Output Level	0.1 dB resolution, 0 dBm to -130 dBm (spec to -120 dBm)
Tx Pattern	CW, AM w/ 1 kHz, FM w/ 1 kHz

RF Characteristics

Power Level Accuracy	2.0 dB (CW Pattern, temperature range 15 °C to 35 °C, -120 dBm to 0 dBm) typical
Frequency Range	500 kHz to 1.6 GHz
Frequency Accuracy	Same as Spectrum Analyzer



Internal Power Meter

Frequency	Center/Start/Stop, Span, Frequency Step, Signal Standard, Channel #, Full Band
Amplitude	Maximum, Minimum, Offset, Relative On/Off, Units, Auto Scale
Average	Acquisition Fast/Med/Slow, # of Running Averages
Limits	Limit On/Off, Limit Upper/Lower
Frequency Range	10 MHz to 1.6 GHz (Standard), 10 MHz to 6 GHz (Option 6)
Span	1 kHz to 100 MHz
Display Range	-140 dBm to +30 dBm, ≤ 40 dB span
Measurement Range	-120 dBm to +26 dBm
Offset Range	0 dB to +100 dB
VSWR	2:1 typical
Maximum Power	Same as RF In Damage Level
Accuracy	Same as Spectrum Analyzer
Application Option	Impedance (50 Ω, 75 Ω, Other)



High Accuracy Power Meter (Option 19) (Requires external USB power sensor, sold separately)

Amplitude	Maximum, Minimum, Offset, Relative On/Off, Units, Auto Scale				
Average	# of Running Averages, Max Hold				
Zero/Cal	Zero On/Off, Cal Factor (Center Frequency, Signal Standard)				
Limits	Limit On/Off, Limit Upper/Lower				
Power Sensor Model	MA24105A	MA24106A	MA24108A/18A/26A	MA24208A/18A	MA24330A/40A/50A
Description	Inline High Power Sensor	High Accuracy RF Power Sensor	Microwave USB Power Sensor	Microwave Universal USB Power Sensor	Microwave CW USB Power Sensor
Frequency Range	350 MHz to 4 GHz	50 MHz to 6 GHz	10 MHz to 8/18/26 GHz	10 MHz to 8/18 GHz	10 MHz to 33/40/50 GHz
Connector	Type N(f), 50 Ω	Type N(m), 50 Ω	Type N(m), 50 Ω (8/18 GHz) Type K(m), 50 Ω (26 GHz)	Type N(m), 50 Ω	Type K(m), 50 Ω (33/40 GHz) Type V(m), 50 Ω (50 GHz)
Dynamic Range	+3 dBm to +51.76 dBm (2 mW to 150 W)	-40 dBm to +23 dBm (0.1 μW to 200 mW)	-40 dBm to +20 dBm (0.1 μW to 100 mW)	-60 dBm to +20 dBm (1 nW to 100 mW)	-70 dBm to +20 dBm (0.1 nW to 100 mW)
Measurand	True-RMS	True-RMS	True-RMS, Slot Power, Burst Average Power	True-RMS, Slot Power, Burst Average Power	Average Power
Measurement Uncertainty	± 0.17 dB ^a	± 0.16 dB ^b	± 0.18 dB ^c	± 0.17 dB ^d	± 0.17 dB ^e
Data sheet (for complete specifications)	11410-00621	11410-00424	11410-00504	11410-00841	11410-00906

- Notes:
- a. Expanded uncertainty with K=2 for power measurements of a CW signal greater than +20 dBm with a matched load. Measurement results referenced to the input side of the sensor.
 - b. Total RSS measurement uncertainty (0 °C to 50 °C) for power measurements of a CW signal greater than -20 dBm with zero mismatch errors.
 - c. Expanded uncertainty with K=2 for power measurements of a CW signal greater than -20 dBm with zero mismatch errors.
 - d. Power uncertainty expressed with two sigma confidence level for CW measurement after zero operation. Includes calibration factor and linearity over temperature uncertainties, but not the effects of mismatch, zero set and drift, or noise.
 - e. Includes linearity over temperature uncertainties, but not the effects of calibration factor, mismatch, zero set and drift, and noise.

 **NBFM Analyzer and Coverage Mapping**

Measurements

NBFM Analyzer	NBFM Talk-Out Coverage (requires Option 31 GPS and a suitable GPS antenna)
Carrier Power	RSSI
Carrier Frequency	THD
Frequency Error	SINAD
FM Deviation (Peak, Average, RMS)	External SINAD
Modulation Rate	
SINAD	
Quieting	
THD	
Occupied Bandwidth (% Int Pwr or > dBc method)	
Decoded CTCSS/DCS/DTMF	
Encoded CTCSS/DCS/DTMF	

Graphs

NBFM Analyzer	NBFM Talk-Out Coverage
Spectrum	Outdoor measured values are overlaid on a geo-tagged map, or displayed on a value vs. time graph. Captured data is exportable to both KML and CSV text (requires Option 31 GPS and a suitable GPS antenna). Indoor measured values are referenced by creating touchscreen points on a floorplan.
Audio Spectrum	
Audio Waveform/Scope	
Summary Display	

Setup Parameters

Frequency	Receive Frequency, Transmit Frequency, Span, Offset
Amplitude	Reference level, Scale, Ext Attenuation, Auto Range, Adjust Range
Setup	Tone Type (CTCSS, DCS, DTMF)
Filters	High Pass (300 Hz, 3 kHz, None) and Low Pass (300 Hz, 3 kHz, 15 kHz, None) De-emphasis On/Off
Measurement	NBFM Analyzer, NBFM Coverage, Quieting, SINAD
Auto Scan	Detection and frequency lock when RF In > +10 dBm, FM or CW signal
Tx Patterns	CW, FM w/ CTCSS/DCS/DTMF, FM w/ CTCSS/DCS/DTMF + Tone Modulation, FM + Tone Modulation
NBFM Analyzer	Active Graph, Maximize Active Trace, Graph Type, Audio Span, Audio Sweep Time, Occupied Bandwidth, Frequency Display (Carrier or Error)
Graph Type	Spectrum, Audio Spectrum, Audio Waveform/Scope, Summary Display
NBFM Coverage (requires Option 31 GPS)	Display Type (Map or Time Graph) USB Memory File formats: .nbfm, .kml, both Log data On/Off

RF Measurements (temperature range 15 °C to 35 °C)

Received Power dBm	± 1.25 dB, ± 0.5 dB typical
Frequency Error Hz	± 10 Hz + Frequency Reference
SINAD/Quieting	Audio In port conforms to TIA-603-D for input voltage and impedance
Additional Summary Measurements	Deviation Modulation Rate THD Occupied Bandwidth
Tone Decode	CTCSS/DCS (standard tones per TIA-603-D), DTMF

Coverage Measurements

RSSI, SINAD, THD

 **NBFM Signal Generator**

Setup Parameters

Generator	On/Off
TX Output Level	0.1 dB resolution, 0 dBm to -130 dBm (spec to -120 dBm)
Frequency Accuracy	Same as Spectrum Analyzer



P25/P25p2 Analyzer and P25/P25p2 Talk-Out Coverage (Options 521 and 522)

Measurements	
P25/P25p2 Analyzer (Option 521)	P25/P25p2 Talk-Out Coverage (Option 522, requires Options 31 and 521)
Received Power Frequency Error Modulation Fidelity NAC (hex) Symbol Rate Error BER (1011 for P25, 1031 for P25p2), O.153 (P25), Voice, and Control Channel Symbol Deviation Hexadecimal Display of Control Channel Traffic SINR (Control Channel)	BER RSSI Modulation Fidelity
Graphs	
P25/P25p2 Analyzer (Option 521)	P25/P25p2 Talk-Out Coverage (Option 522, requires Options 31 and 521)
Constellation (P25 only) Linear Constellation Spectrum [Spans (kHz) = 25, 50, 100, 500, 1000, 5000] Histogram Eye Diagram Demodulation Summary Display Base Station Control Channel Summary Displays (Active Control Channel, Band Plan, Backup Control Channel, Adjacent Site Summary) TDMA Power Profile (P25p2 only)	Outdoor measured values are overlaid on a geo-tagged map, or displayed on a value vs time graph, and are exportable to both KML and CSV text (requires Option 31 GPS and a suitable GPS antenna). Indoor measured values are referenced by creating touchscreen points on a floorplan.
Standards Compliance	
P25	Relevant sections of TIA-102.CAAA-C
P25 Phase 2	Relevant sections of TIA-102.CCAA
SINR	TIA TSB-88.1-E
Setup Parameters	
Frequency	Receive Frequency, Transmit Frequency, Span, Offset
Amplitude	Reference level, Scale, Ext Attenuation, Auto Range, Adjust Range
Setup	P25 Modulation Types: C4FM, CQPSK P25 BER patterns: 1011, O.153 (V.52), Voice, Control Channel P25 Phase 2 Modulation Types: Base Station (H-DQPSK) & Mobile Station (H-CPM) P25 Phase 2 BER patterns: 1031, Silence, Voice, Control Channel Averaging, WACN ID, System ID, Color Code, Descrambling (Off/On)
Measurement	P25 Analyzer, P25 Coverage
P25/P25p2 Analyzer	Active Graph, Maximize Active Trace, Graph Type, Symbol Span
Graph Type	Constellation (P25 only), Linear Constellation, Spectrogram, Histogram, Eye Diagram, Demodulation Summary Display, Base Station Control Channel Summary Displays (Active Control Channel, Band Plan, Backup Control Channel, Adjacent Site Summary)
Eye Diagram Symbol Span	2, 3, 4, 5
P25/P25p2 Coverage	USB Memory File formats .p25, .kml, both (Option 522, requires Option 31 GPS)
Log Data	On/Off
RF Measurements (Option 521) (temperature range 15 °C to 35 °C)	
Received Power dBm	± 1.25 dB, ± 0.5 dB typical
Frequency Error Hz	± 10 Hz + Frequency Reference
SINR dB	± 1.5 dB from 10 to 25 dB; ± 2.0 dB from 0 to 10 dB and 25 to 30 dB
Additional Summary Measurements	Modulation Fidelity (%) BER/MER (%) Symbol Deviation (Hz) Network Access Code (Hex) Symbol Rate Error (Hz)
Coverage Measurements (Option 522)	
	RSSI, BER, Modulation Fidelity



P25/P25p2 Signal Generator

Setup Parameters

Generator	On/Off
Tx Output Level	0.1 dB resolution, 0 dBm to -130 dBm (spec to -120 dBm)
P25 Tx Patterns	P25: 1011, 1011 Cal, Interference, Silence, Busy, Idle, High Dev, Low Dev, O.153 (v. 52) p25_ism: 1011, 511 (O.153/v.52), 1011 Cal, Interference, Silence, Busy, Idle, Fidelity CW, AM and FM
P25p2 Tx Patterns	Base Station (H-DQPSK): 1031, 1031 Cal, Silence Mobile Station (H-CPM, Selectable timeslot): 1031, 1031 Cal, Silence CW, AM, FM

RF Characteristics

Power Level Accuracy	2.0 dB (CW Pattern, temperature range 15 °C to 35 °C, -120 dBm to 0 dBm) typical
Frequency Accuracy	Same as Spectrum Analyzer
Frequency Range	500 kHz to 1.6 GHz
P25 Modulation Fidelity	< 1.25 % max, < 0.75 % typical
P25p2 Modulation Fidelity	< 2.0 % max, < 1.75 % typical



DMR (MOTOTRBO) Analyzer and DMR Talk-Out Coverage (Options 591 and 592)

Measurements	
DMR (MOTOTRBO) Analyzer (Option 591)	DMR Talk-Out Coverage (Option 592, requires Options 31 and 591)
Received Power Frequency Error Modulation Fidelity Color Code (decimal) RX Timeslot (Base Station only) Symbol Rate Error Symbol Deviation Base Station: 1031, 1031-1 % BER, O.153, O.153-1 % BER, Silence, tscc Mobile Station: 1031, 1031-1 % BER, O.153, O.153-1 % BER, Silence Repeater Receiver Sensitivity Test CW, AM, FM	BER RSSI Modulation Fidelity

Graphs	
DMR (MOTOTRBO) Analyzer (Option 591)	DMR Talk-Out Coverage (Option 592, requires Options 31 and 591)
Constellation Linear Constellation Spectrum [Spans (kHz) = 25, 50, 100, 500, 1000, 5000] Histogram Eye Diagram Summary Display DMR Summary Power Profile	Outdoor measured values are overlaid on a geo-tagged map, or displayed on a value vs. time graph, and are exportable to both KML and CSV text (requires Option 31 GPS and a suitable GPS antenna). Indoor measured values are referenced by creating touchscreen points on a floorplan.

Setup Parameters	
Frequency	Receive Frequency, Transmit Frequency, Span, Rx/Tx Coupling, Coupling Offset
Amplitude	Reference level, Scale, Ext Attenuation, Auto Range, Adjust Range
Setup	Modulation Type (Base Station, Mobile Station), BER pattern (1031, O.153, Voice, Silence)
Measurement	DMR Analyzer, DMR Coverage, DMR Bit Capture
DMR Analyzer	Active Graph, Maximize Active Trace, Graph Type, Symbol Span
Graph Type	Constellation, Linear Constellation, Spectrogram, Histogram, Eye Diagram, Summary, DMR Summary, Power Profile
Eye Diagram Symbol Span	2, 3, 4, 5
DMR Coverage (Option 592, requires Option 31 GPS)	USB Memory File formats .dmr2, .kml, both Log data On/Off

RF Measurements (Option 591) (temperature range 15 °C to 35 °C)	
Received Power dBm	± 1.25 dB, ± 0.5 dB typical
Frequency Error Hz	± 10 Hz + Frequency Reference
Summary Measurements	Received Power, Frequency Error, Modulation Fidelity, BER, Symbol Deviation, Color Code, Symbol Rate Error
DMR Summary Measurements	MS ID, Target ID, Talk Group ID, FID, Call Type, Base Station ID

Coverage Measurements (Option 592)	
	RSSI, BER, Modulation Fidelity



DMR Signal Generator

Setup Parameters	
Generator	On/Off
Tx Output Level	0.1 dB resolution, 0 dBm to -130 dBm (spec to -120 dBm)
Tx Pattern	Base Station: 1031, 1031-1 % BER, O.153, O.153-1 % BER, Silence, tscc Mobile Station: 1031, 1031-1 % BER, O.153, O.153-1 % BER, Silence CW, AM, FM

RF Characteristics	
Power Level Accuracy	2.0 dB (CW Pattern, temperature range 15 °C to 35 °C, -120 dBm to 0 dBm) typical
Frequency Range	500 kHz to 1.6 GHz
Mod Fidelity	1.25 % max, 0.75 % typical
Frequency Accuracy	Same as Spectrum Analyzer

 **dPMR Analyzer (Options 573 and 572)**

Measurements	
dPMR RF Analyzer (Option 573)	dPMR Talk-Out Coverage (Option 572, requires Options 31 and 573)
Received Power Frequency Error Modulation Fidelity Symbol Rate Error Symbol Deviation	RSSI Modulation Fidelity

Graphs	
dPMR RF Analyzer (Option 573)	dPMR Talk-Out Coverage (Option 572, requires Options 31 and 573)
Constellation Linear Constellation Spectrum [Spans (kHz) = 25, 50, 100, 500, 1000, 5000] Histogram Eye Diagram Summary Display	Outdoor measured values are overlaid on a geo-tagged map and exportable to both KML and CSV text (requires Option 31 GPS and a suitable GPS antenna). Indoor measured values are referenced by creating touchscreen points on a floorplan.

Setup Parameters	
Frequency	Receive Frequency, Transmit Frequency, Span, Offset
Amplitude	Reference level, Scale, Ext Attenuation, Auto Range, Adjust Range
Setup	Modulation Bandwidth (6.25 kHz)
Measurement	dPMR Analyzer, dPMR Coverage
dPMR Analyzer	Active Graph, Maximize Active Trace, Graph Type, Symbol Span
Graph Type	Constellation, Linear Constellation, Spectrogram, Histogram, Eye Diagram, Summary
Eye Diagram Symbol Span	2, 3, 4, 5
dPMR Coverage	USB Memory File formats .dpmr, .kml, both Log data On/Off

RF Measurements (Option 573) (temperature range 15 °C to 35 °C)	
Received Power dBm	± 1.25 dB, ± 0.5 dB typical
Frequency Error Hz	± 10 Hz + Frequency Reference
Additional Summary Measurements	Modulation Fidelity (%) Symbol Deviation (Hz) Symbol Rate Error (Hz)

Coverage Measurements (Option 572)	
	RSSI, Modulation Fidelity

 **Signal Generator**

Setup Parameters	
Generator	On/Off
Tx Output Level	0.1 dB resolution, 0 dBm to -130 dBm (spec to -120 dBm)
Tx Patterns	CW, AM, FM, O.153

RF Characteristics	
Power Level Accuracy	2.0 dB (CW Pattern, temperature range 15 °C to 35 °C, -120 dBm to 0 dBm) typical
Frequency Range	500 kHz to 1.6 GHz
Frequency Accuracy	Same as Spectrum Analyzer



NXDN Analyzer and NXDN Talk-Out Coverage (Options 531 and 532)

Measurements

NXDN Analyzer (Option 531)	NXDN Talk-Out Coverage (Option 532, requires Options 31 and 531)
Received Power Frequency Error Modulation Fidelity RAN (decimal) Symbol Rate Error BER (1031, O.153, Voice, and Control Channel) Symbol Deviation	BER RSSI Modulation Fidelity

Graphs

NXDN Analyzer (Option 531)	NXDN Talk-Out Coverage (Option 532, requires Options 31 and 531)
Constellation Linear Constellation Spectrum [Spans (kHz) = 25, 50, 100, 500, 1000, 5000] Histogram Eye Diagram Summary Display	Outdoor measured values are overlaid on a geo-tagged map and exportable to both KML and CSV text (requires Option 31 GPS and a suitable GPS antenna). Indoor measured values are referenced by creating touchscreen points on a floorplan.

Setup Parameters

Frequency	Receive Frequency, Transmit Frequency, Span, Offset
Amplitude	Reference level, Scale, Ext Attenuation, Auto Range, Adjust Range
Setup	Modulation Bandwidth (6.25 kHz and 12.5 kHz), BER pattern (1031, O.153, Voice, Control Channel)
Measurement	NXDN Analyzer, NXDN Coverage
NXDN Analyzer	Active Graph, Maximize Active Trace, Graph Type, Symbol Span
Graph Type	Constellation, Linear Constellation, Spectrogram, Histogram, Eye Diagram, Summary
Eye Diagram Symbol Span	2, 3, 4, 5
NXDN Coverage (Option 532, requires Option 31 GPS)	USB Memory File formats .nxdn, .kml, both Log data On/Off

RF Measurements (Option 531)

	(temperature range 15 °C to 35 °C)
Received Power dBm	± 1.25 dB, ± 0.5 dB typical
Frequency Error Hz	± 10 Hz + Frequency Reference
Additional Summary Measurements	Modulation Fidelity (%) BER/MER (%) Symbol Deviation (Hz) Radio Access Number (RAN) Decimal Symbol Rate Error (Hz)

Coverage Measurements (Option 532)

RSSI, BER, Modulation Fidelity



NXDN Signal Generator

Setup Parameters

Modulation Bandwidth	6.25 kHz, 12.5 kHz
Generator	On/Off
Tx Output Level	0.1 dB resolution, 0 dBm to -130 dBm (spec to -120 dBm)
Tx Patterns (9600 and 4800)	1031, O.153 (v. 52), High Dev, Low Dev, UDCH Pattern 10, CAC, 1031 DTS, FACCH3 DTS, Framed PN9, 1031 Cal, CW, AM, FM

RF Characteristics

Power Level Accuracy	2.0 dB (CW Pattern, temperature range 15 °C to 35 °C, -120 dBm to 0 dBm) typical
Frequency Range	500 kHz to 1.6 GHz
Mod Fidelity	1.25 % max
Frequency Accuracy	Same as Spectrum Analyzer



TETRA Analyzer and TETRA Coverage Mapping (Options 581 and 582)

Measurements	
TETRA Analyzer (Option 581)	TETRA Coverage (Option 582, requires Options 31 and 581)
Received Power Frequency Error Vector Error, RMS and Peak Bit Error Rate (BER) Residual Carrier Magnitude IQ Imbalance Magnitude & Phase Error Symbol Rate Error Base Station Extended Color Code Base Station Receiver Sensitivity Test	RSSI BER RMS Vector Error (EVM)

Graphs	
TETRA Analyzer (Option 581)	TETRA Coverage (Option 582, requires Options 31 and 581)
Constellation Spectrum [Spans (kHz) = 25, 50, 100, 500, 1000, 5000] Eye Diagram Summary Display TETRA Summary	Outdoor measured values are overlaid on a geo-tagged map and exportable to both KML and CSV text (requires Option 31 GPS and a suitable GPS antenna). Indoor measured values are referenced by creating touchscreen points on a floorplan.

Setup Parameters	
Frequency	Receive Frequency, Tx Frequency, Rx Coupling, Coupling Offset, Span
Amplitude	Reference level, Scale, Ext Attenuation, Auto Range, Adjust Range, Tx Output Lvl, Tx Power Offset, Units
Setup	Mod Type, Rx Pattern, Tx Pattern, Squelch Lvl, Numeric Averaging
Measurements	TETRA Analyzer, TETRA Coverage, TETRA BS Sensitivity
TETRA Analyzer	Active Graph, Maximize Active Graph, Graph Type, Symbol Span
Graph Type	Constellation, Spectrum, Eye Diagram, Summary, TETRA Summary
Eye Diagram Symbol Span	2, 3, 4, 5
TETRA Coverage (Option 582, requires Option 31 GPS)	USB Memory File formats .tetra, .kml, or both Log data On/Off

RF Measurements (Option 581)	
Received Power dBm	(temperature range 15 °C to 35 °C) ± 1.25 dB, ± 0.5 dB typical
Frequency Error Hz	± 10 Hz + Frequency Reference
Additional Summary Measurements	Vector Error, RMS and Peak (%) BER Residual Carrier Magnitude (%) IQ Imbalance (dB) Phase Error (Degrees) Magnitude Error (%) Symbol Rate Error (Hz)
TETRA Summary Measurements	Mobile Color Code (Decimal) Mobile Network Code (Decimal) Base Station Color Code (Decimal) Base Station Extended Color Code (Hex) Location Area Code (Decimal) Mobile Station Maximum Transmit Power (dBm)

Coverage Measurements (Option 582)	
	RSSI, BER, RMS Vector Error (EVM)



TETRA Signal Generator

Setup Parameters	
Modulation Type	Π/4 (Pi/4) DQPSK
Generator	On/Off
Tx Output Level	0.1 dB resolution, 0 dBm to -130 dBm (spec to -120 dBm)
Base Station Test Patterns	tetra_bs_idle_unallocPCH tetra_bs_busy_allocPCH T1_TCH_7p2 (Airbus TB3, Hytera, Sepura, Motorola, ETELM NeTIS)

RF Characteristics	
Power Level Accuracy	2.0 dB (CW Pattern, temperature range 15 °C to 35 °C, -120 dBm to 0 dBm) typical
Frequency Range	500 kHz to 1.6 GHz
EVM	3.5 % max
Frequency Accuracy	Same as Spectrum Analyzer



PTC-ITCR Analyzer and PTC-ITCR Talk-Out Coverage (Options 721 and 722)

Measurements	
PTC-ITCR Analyzer (Option 721)	PTC-ITCR Talk-Out Coverage (Option 722, requires Options 31 and 721)
Received Power Burst Power Peak Envelope Power Frequency Error Π/4 DQPSK: Error Vector Magnitude, BER, IQ Offset, Phase Error, Magnitude Error, Symbol Rate Error	BER RSSI Modulation Fidelity
Graphs	
PTC-ITCR Analyzer (Option 721)	PTC-ITCR Talk-Out Coverage (Option 722, requires Options 31 and 721)
Constellation Linear Constellation Spectrum [Spans (kHz) = 25, 50, 100, 500, 1000, 5000] Histogram Eye Diagram Summary Display	Outdoor measured values are overlaid on a geo-tagged map, or displayed on a value vs time graph, and are exportable to both KML and CSV text (requires Option 31 GPS and a suitable GPS antenna). Indoor measured values are referenced by creating touchscreen points on a floorplan.
Setup Parameters	
Frequency	Receive Frequency, Transmit Frequency, Offset, Span, Signal Standard, AAR Channel #
Amplitude	Reference level, Scale, Ext Attenuation, Auto Range, Adjust Range
Setup	RX Pattern (O.153/V.52, PN9 Normal), Symbol Rate (Half Rate 8 ksps, Full Rate 16 ksps), TX Pattern (O.153 Continuous, PN9 Normal Types 1-4, PN9 Normal Continuous), CW, AM 1 kHz tone, FM 1 kHz tone
Measurement	PTC-ITCR Analyzer, PTC-ITCR Coverage
PTC-ITCR Analyzer	Active Graph, Maximize Active Trace, Graph Type, Symbol Span
Graph Type	Constellation, Linear Constellation, Spectrum, Histogram, Eye Diagram, Summary
Eye Diagram Symbol Span	2, 3, 4, 5
PTC-ITCR Coverage (Option 722)	USB Memory File formats .ptc and .kml (both require Options 31 and 731)
Log data	On/Off
RF Measurements (Option 721)	
	(temperature range 15 °C to 35 °C)
Received Power dBm	± 1.25 dB, ± 0.5 dB typical
Burst Power dBm	± 1.25 dB, ± 0.5 dB typical
Peak Envelope Power dBm	± 1.25 dB, ± 0.5 dB typical
Frequency Error Hz	± 10 Hz + Frequency Reference
Additional Summary Measurements	Error Vector Magnitude % BER % IQ Offset dB Phase Error degrees Magnitude Error % Symbol Rate Error (Hz)
Coverage Measurements (Option 722) (Requires Options 31 and 721)	
	RSSI, BER, Modulation Fidelity



PTC-ITCR Signal Generator

Setup Parameters	
Modulation Type	Π/4 DQPSK
Symbol Rate (ksps)	8 (Half Rate), 16 (Full Rate)
Generator	On/Off
Tx Output Level	0.1 dB resolution, 0 dBm to -130 dBm (spec to -120 dBm)
Tx Pattern	PN9 Continuous, PN9 Burst, CW, AM, FM
RF Characteristics	
Power Level Accuracy	2.0 dB (CW Pattern, temperature range 15 °C to 35 °C, -120 dBm to 0 dBm) typical
Frequency Range	500 kHz to 1.6 GHz
EVM	3.5 % max
Frequency Accuracy	Same as Spectrum Analyzer



PTC-ACES Analyzer and PTC ACSES Talk-Out Coverage (Options 731 and 733)

Measurements

PTC-ACES Analyzer (Option 731, requires Option 31 GPS)	PTC-ACES Talk-Out Coverage (Option 733, requires Options 31 and 731)
Received PowerPeak Envelope Power Frequency Error GMSK: Error Vector Magnitude, BER, Phase Error, Magnitude Error RS decoder	BER RSSI EVM PER

Graphs

PTC-ACES Analyzer (Option 731, requires Option 31 GPS)	PTC-ACES Talk-Out Coverage (Option 733, requires Option 31 and 731)
Constellation Spectrum [Spans (kHz) = 25, 50, 100, 500, 1000, 5000] Eye Diagram	Outdoor measured values are overlaid on a geo-tagged map, or displayed on a value vs time graph, and are exportable to both KML and CSV text (requires Option 31 GPS and a suitable GPS antenna).

Setup Parameters

Frequency	Receive Frequency, Transmit Frequency, Receive/Transmit Coupling, Coupling Offset, Span, Signal Standard, AAR Channel #
Amplitude	Ref Level, Scale, Receive Power Offset, Auto Receive Range, Adjust Receive, Transmit Output Level, Transmit Power Offset, Receive and Transmit units
Setup	Averaging, Reset PER Counter, Receive Trigger Setup, Decode Setup, Squelch Level
Measurement	PTC-ACES Analyzer, PTC-ACES Coverage, PTC-ACES Radio Receiver Tester
PTC-ACES Analyzer	Active Graph, Maximize Active Trace, Graph Type, Symbol Span
Graph Type	Constellation, Spectrum, Eye Diagram, Summary, Payload, and Decoded message (only for unencrypted)
Eye Diagram Symbol Span	2, 3, 4, 5
PTC-ACES Coverage (Option 733)	USB Memory File formats .ptc and .kml, both (requires Option 31 GPS)
Log data	On/Off

RF Measurements (Option 731)

	(temperature range 15 °C to 35 °C)
Received Power dBm	± 1.25 dB, ± 0.5 dB typical
Peak Envelope Power dBm	± 1.25 dB, ± 0.5 dB typical
Frequency Error Hz	± 10 Hz + time base error, 99% confidence level
Additional Summary Measurements	Error Vector Magnitude % BER % PER Rx Packets Phase Error degrees Magnitude Error % Requires Option 31

Message Decode Table and Payload Table

Message Decode	Parsed information (ATCS addresses, time slot in Frame and Epoch)
Payload	Hex over-the-air

Coverage Measurements (Option 733)

RSSI, BER, EVM (require Options 31 and 731)



PTC ACSES Signal Generator

Setup Parameters

Modulation Type	GMSK
Symbol Rate (bps)	9600
Generator	On/Off
Tx Output Level	0 dBm to -130 dBm (spec to -120 dBm)
Tx Pattern	Generic TSR ¹ , TSR+beacon, Customer pattern, CW, AM, FM

RF Characteristics

Power Level Accuracy	2.0 dB (CW Pattern, temperature range 15 °C to 35 °C, -120 dBm to 0 dBm) typical
Frequency Range	500 kHz to 1.6 GHz
Frequency Accuracy	Same as Spectrum Analyzer

1. Temporary Speed Restriction

 **AM/FM/PM Signal Analyzers (Option 509)**

Measurements

Display Type	RF Spectrum AM/FM/PM	Audio Spectrum (AM)	Audio Spectrum (FM/PM)	Audio Waveform (AM)	Audio Waveform (FM/PM)	Summary (AM)	Summary (FM/PM)
Graphic Display	Power (dBm) vs. Frequency	Depth (%) vs. Modulation Frequency	Deviation (kHz/rad) vs. Modulation Frequency	Depth (%) vs. Time	Deviation (kHz/rad) vs. Time	None	None
Numerical Displays	Carrier Power Carrier Frequency Occupied Bandwidth	AM Rate RMS Depth (Pk-Pk)/2 Depth SINAD ^a THD ^a Distortion/Total Vrms ^a	FM/PM Rate RMS Deviation (Pk-Pk)/2 Deviation SINAD ^a THD ^a Distortion/Total Vrms ^a	AM Rate RMS Depth (Pk-Pk)/2 Depth SINAD ^a THD ^a Distortion/Total Vrms ^a	FM/PM Rate RMS Depth (Pk-Pk)/2 Depth SINAD ^a THD ^a Distortion/Total Vrms ^a	RMS Depth (AM) Peak + Depth Peak - Depth (Pk-Pk)/2 Depth Carrier Power Carrier Frequency Occupied Bandwidth AM Rate SINAD ^a THD ^a Distortion/Total Vrms ^a	RMS Deviation (FM/PM) Peak + Depth Peak - Depth (Pk-Pk)/2 Depth Carrier Power Carrier Frequency Carrier Frequency Occupied Bandwidth AM Rate SINAD ^a THD ^a Distortion/Total Vrms ^a

a. Requires Sinewave modulation

Setup Parameters

Frequency	Center Freq, Span, Freq Step, Signal Standard, Channel, Channel Increment, Set Carrier Freq
Amplitude	Scale, Power Offset, Adjust Range
Setup	Demod Type (AM, FM, PM), IFBW, Auto IFBW
Measurements	RF Spectrum AM/FM/PM, Audio Spectrum (AM/FM/PM), Audio Waveform (AM/FM/PM), Summary (AM/FM/PM), Average
Marker	On/Off, Delta, Peak Search, Marker Freq to Center, Marker to Ref Lvl, Marker Table, All Markers Off

Specifications

AM	Modulation Rate: ± 1 Hz (< 100 Hz), ± 2% (> 100 Hz) Depth: ± 5% for modulation rates 10 Hz to 100 kHz
FM	Modulation Rate: ± 1 Hz (< 100 Hz); ± 2% (100 Hz to 100 kHz) Deviation Accuracy: ± 5% (100 Hz to 100 kHz, IFBW must be greater than 95 % occupied BW)
PM	Modulation Rate: ± 1 Hz (< 100 Hz); ± 2% (100 Hz to 100 kHz) Deviation Accuracy: ± 5% (deviation 0 to 93 Rad, rate 10 Hz to 5 kHz, IFBW must be greater than 95 % occupied BW)
IF Bandwidth	1 kHz to 300 kHz in 1-3 sequence
Frequency Span	RF Spectrum: 10 kHz to 10 MHz Audio Spectrum: 2 kHz, 5 kHz, 10 kHz, 20 kHz
RBW/VBW	30
Span/RBW	100
Sweep time	50 µs to 50 ms (Audio Waveform)

 LTE Signal Analyzers (Options 541, 542, 546, and 886)

Measurements			
RF (Option 541)	Demodulation (Options 542 and 886)	Over-the-Air (OTA) (Option 546)	Pass/Fail (User Editable)
Channel Spectrum Channel Power Occupied Bandwidth ACPR Spectral Emission Mask Category A or B (Opt 1) RF Summary	Power vs. Resource Block (RB) RB Power (PDSCH) Active RBs, Utilization %, Channel Power, Cell ID OSTP, Frame EVM by modulation Constellation QPSK, 16QAM, 64QAM 256QAM Demod (Option 886) Modulation Results Ref Signal Power (RS) Sync Signal Power (SS) EVM - rms, peak, max hold Frequency Error - Hz, ppm Carrier Frequency Cell ID Control Channel Power Bar Graph or Table View RS, P-SS, S-SS PBCH, PCFICH, PHICH, PDCCH Total Power (Table View) EVM Modulation Results Tx Time Alignment Modulation Summary Includes EVM by modulation Antenna Icons Detects active antennas (1/2)	Scanner Cell ID (Group, Sector) S-SS Power, RSRP, RSRQ, SINR Dominance Modulation Results - On/Off Tx Test Scanner RS Power of MIMO antennas (2x2, 4x4) Cell ID, Average Power Delta Power (Max-Min) Graph of Antenna Power Modulation Results - On/Off Mapping On-screen S-SS Power, RSRP, RSRQ, or SINR Scanner Modulation Results - Off	View Pass/Fail Limits All, RF, Modulation Available Measurements Channel Power Occupied Bandwidth ACL Frequency Error Carrier Frequency Dominance EVM peak, rms RS Power RS EVM SS, P-SS, S-SS Power SS, P-SS, S-SS EVM PBCH Power PBCH EVM PCFICH Power PCFICH EVM PHICH Power, EVM PDCCH Power, EVM Cell, Group, Sector ID OSTP Tx Time Alignment

Setup Parameters

Frequency	E-UTRA bands 1 - 5, 7 - 14, 17 - 21, 23 - 32, 66A (tunable 10 MHz to 1.6 GHz; to 6 GHz with Option 6) Center, Signal Standard, Channel #, Closest Channel, Decrement/Increment Channel
Bandwidth	1.4, 3, 5, 10 MHz
Span	Auto, 1.4, 3, 5, 10, 15, 20, 30 MHz
Amplitude	Scale/Division, Power Offset, Auto Range, Adjust Range
Sweep	Single/Continuous, Trigger Sweep
EVM Mode	Auto, PBCH only
Save/Recall	Setup, Measurement, Screen Shot (save only), to internal/external memory
Measurement Summary Screens	Overall Measurements, RF Measurements, Modulation Measurements

RF Measurements (Option 541)

RF Channel Power Accuracy ± 1.5 dB, ± 1.0 dB typical, (RF input -50 dBm to +10 dBm)

Demodulation Measurements (Option 542)

Frequency Error ± 10 Hz + Frequency Reference, 99 % confidence level
Residual EVM (rms) 2.0 % typical (E-UTRA Test Model 3.1, RF Input -50 dBm to +10 dBm) for BW ≤ 10 MHz

Over-the-Air (OTA) Measurements (Option 546)

Scanner Six strongest signals if present
Auto Save — Sync Signal Power and Modulation Results with GPS tagging
Auto Save Scanner — three strongest signals if present
RS Power — strongest signal
Mapping Map On-screen S-SS Power, RSRP, RSRQ, or SINR of Cell ID with strongest signal
Scanner — three strongest signals if present
Save and Export Scanner data: *.kml, *.mtd (tab delimited)



TDD LTE Signal Analyzers (Options 551, 552, and 556) (Option 31 Recommended)

Measurements			
RF (Option 551)	Demodulation (Options 552)	Over-the-Air (OTA) (Option 556)	Pass/Fail (User Editable)
Channel Spectrum	Power vs. Resource Block (RB)	Scanner	View Pass/Fail Limits
Channel Power	RB Power (PDSCH)	Cell ID (Group, Sector)	All, RF, Modulation
Occupied Bandwidth	Active RBs, Utilization %,	S-SS Power, RSRP, RSRQ, SINR	
Power vs. Time	Channel Power, Cell ID	Dominance	Available Measurements
Frame View	OSTP, Frame EVM by modulation	Modulation Results – On/Off	Channel Power
Sub-Frame View	Constellation	Auto Save On/Off	Occupied Bandwidth
Total Frame Power	QPSK, 16QAM, 64QAM	Tx Test	ACL R
DwPTS Power	256QAM Demod (Option 886)	Scanner	Frequency Error
Transmit Off Power	Modulation Results	RS Power of MIMO antennas (2x2, 4x4)	Carrier Frequency
Cell ID	Ref Signal Power (RS)	Cell ID, Average Power	Dominance
Timing Error	Sync Signal Power (SS)	Delta Power (Max-Min)	EVM peak, rms
ACL R	EVM – rms, peak, max hold	Graph of Antenna Power	Frame EVM, rms
Spectral Emission Mask	Frequency Error – Hz, ppm	Modulation Results – On/Off	Frame EVM by mod type
Category A or B (Opt 1)	Carrier Frequency	Mapping	RS, SS Power
RF Summary	Cell ID	On-screen	RS EVM
	Control Channel Power	S-SS Power, RSRP, RSRQ, or SINR	P-SS, S-SS: Power
	Bar Graph or Table View	Scanner	P-SS, S-SS: EVM
	RS, P-SS, S-SS	Modulation Results – On/Off	PBCH: Power, EVM
	PBCH, PCFICH, PHICH, PDCCH	Carrier Aggregation	PCFICH: Power, EVM
	Total Power (Table View)	Up to 5 component carriers (CC1 to CC5)	PHICH: Power, EVM
	EVM	CP, MIMO status, RS & SS Power, EVM,	PDCCH: Power, EVM
	Modulation Results	Frequency Error, Time Alignment Error,	Cell, Group, Sector ID
	Tx Time Alignment	Cell ID	OSTP
	Modulation Summary		Tx Time Alignment
	Includes EVM by modulation		Frame Power (TDD option 551)
	Antenna Icons		DwPTS Power (TDD option 551)
	Detects active antennas (1/2)		Transmit Off Power (TDD option 551)
			Timing Error (TDD option 551)

Setup Parameters

Frequency	E-UTRA bands 1 – 5, 7 – 14, 17 – 21, 23 – 32, 66A (tunable 10 MHz to 1.6 GHz; to 6 GHz with Option 6)
Center, Signal Standard, Channel #, Closest Channel, Decrement/Increment Channel	
Bandwidth	1.4, 3, 5, 10 MHz
Span	Auto, 1.4, 3, 5, 10, 15, 20, 30 MHz
Amplitude	Scale/Division, Power Offset, Auto Range, Adjust Range
Sweep	Single/Continuous, Trigger Sweep
EVM Mode	Auto, PBCH only
Save/Recall	Setup, Measurement, Screen Shot (save only), to internal/external memory
Measurement Summary Screens	Overall Measurements, RF Measurements, Modulation Measurements

RF Measurements (Option 551)

RF Channel Power Accuracy ± 1.5 dB, ± 1.0 dB typical, (RF input –30 dBm to +10 dBm)

Demodulation Measurements (Option 552)

Frequency Error ± 10 Hz + Frequency Reference, 99 % confidence level
 Residual EVM (rms) 2.0 % typical (E-UTRA Test Model 3.1, RF Input –50 dBm to +10 dBm) for BW ≤ 10 MHz

Over-the-Air (OTA) Measurements (Option 556)

Scanner Six strongest signals if present
 Auto Save — Sync Signal Power and Modulation Results with GPS tagging
 Tx Test Show Mod Results
 Mapping Map On-screen S-SS Power, RSRP, RSRQ, or SINR of Cell ID with strongest signal
 Scanner — three strongest signals if present
 Save and Export Scanner data: *.kml, *.mtd (tab delimited)

 **GSM/GPRS/EDGE Measurements (Option 880)**

Measurements

RF	Demodulation	Over-the-Air (OTA)	Pass/Fail
Channel Spectrum Channel Power Occupied Bandwidth Burst Power Average Burst Power Frequency Error Modulation Type BSIC (NCC, BCC)	Phase Error EVM Origin Offset C/I Modulation Type Magnitude Error	There are no additional OTA Measurements RF and Demodulation Measurements can be made OTA	View Pass/Fail Limits GSM, EDGE Available Measurements Channel Power Occupied Bandwidth Burst Power Average Burst power Frequency Error Phase Error Script Master™
Multi-channel Spectrum Power vs. Time (Frame/Slot) Channel Power Occupied Bandwidth Burst Power Average Burst Power Frequency Error Modulation Type BSIC (NCC, BCC)			

Setup Parameters

GSM/EDGE Select	Auto, GSM, EDGE
Frequency	Center, Signal Standard, Channel #, Closest Channel, Decrement/Increment Channel
Amplitude	Power Offset, Auto Range, Adjust Range
Sweep	Single/Continuous, Trigger Sweep
Save/Recall	Setup, Measurement, Screen Shots (JPEG - save only), to internal/external memory
Measurement Summary Screen	Overall Measurements

RF Measurements

Frequency Error	± 10 Hz + time base error, 99 % confidence level
Occupied Bandwidth	Bandwidth within which lies 99 % of the power transmitted on a single channel
Burst Power Error	± 1.5 dB; ± 1 dB typical (-50 dBm to +20 dBm)

Demodulation Measurements

GMSK Modulation Quality (RMS Phase)	
Measurement Accuracy	± 1°
Residual Error (GMSK)	1°
8PSK Modulation Quality (EVM)	
Measurement Accuracy	± 1.5 %
Residual Error (8PSK)	2.5 %



IEEE 802.16 Fixed WiMAX Signal Analyzers (Options 46 and 47) (Requires Option 6)

Measurements			
RF (Option 46)	Demodulation (Option 47)	Over-the-Air (OTA)	Pass/Fail (User Editable)
Channel Spectrum Channel Power Occupied Bandwidth Power vs. Time Channel Power Preamble Power Data Burst Power Crest Factor ACPR	Constellation RCE (RMS/Peak) EVM (RMS/Peak) Frequency Error Carrier Frequency Base Station ID Spectral Flatness Adjacent Subcarrier Flatness EVM vs. Subcarrier/Symbol RCE EVM Frequency Error Carrier Frequency Base Station ID	There are no additional OTA Measurements. RF Measurements and Demodulation can be made OTA.	Channel Power Occupied Bandwidth Burst Power Preamble Power Crest Factor Frequency Error Carrier Frequency EVM RCE Base Station ID

Setup Parameters

Bandwidth	1.25, 1.50, 2.50, 3.50, 5.00, 5.50, 6.00, 7.00, 10.00 MHz
Cyclic Prefix Ratio (CP)	1/4, 1/8, 1/16, 1/32
Span	5, 10, 15, 20 MHz
Frame Length	2.5, 5.0, 10.0 ms
Frequency	Center, Signal Standard, Channel #, Closest Channel, Decrement/Increment Channel
Amplitude	Scale/Division, Power Offset, Auto Range, Adjust Range
Sweep	Single/Continuous, Trigger Sweep
Save/Recall	Setup, Measurement, Screen Shot (save only), to internal/external memory
Measurement Summary Screens	Overall Measurements, RF Measurements, Signal Quality Measurements

RF Measurements (Option 46) (temperature range 15 °C to 35 °C)

RF Channel Power Accuracy ± 1.5 dB, ± 1.0 dB typical, (RF input -50 dBm to +20 dBm)

Demodulation (Option 47) (temperature range 15 °C to 35 °C)

Frequency Error 0.07 ppm + Frequency Reference, 99 % confidence level
Residual EVM (rms) 3 % typical, 3.5 % max (RF Input -50 dBm to +20 dBm)



IEEE 802.16 Mobile WiMAX Signal Analyzers (Options 66, 67, and 37)

(Requires Option 6, Option 37 requires Option 31 for full functionality)

Measurements			
RF (Option 66)	Demodulation (Option 67)	Over-the-Air (OTA) (Option 37)	Pass/Fail (User Editable)
Channel Spectrum	Constellation	Channel Power Monitor	Channel Power
Channel Power	RCE (RMS/Peak)	Preamble Scanner (Six)	Occupied Bandwidth
Occupied Bandwidth	EVM (RMS/Peak)	Preamble	Downlink Burst Power
Power vs. Time	Frequency Error	Relative Power	Uplink Burst Power
Channel Power	CINR	Cell ID	Preamble Power
Preamble Power	Base Station ID	Sector ID	Crest Factor
Downlink Burst Power	Sector ID	PCINR	Frequency Error
Uplink Burst Power	Spectral Flatness	Dominant Preamble	Carrier Frequency
ACPR	Adjacent Subcarrier Flatness	Base Station ID	EVM
	EVM vs. Subcarrier/Symbol		RCE
	RCE (RMS/Peak)		Sector ID
	EVM (RMS/Peak)		
	Frequency Error		
	CINR		
	Base Station ID		
	Sector ID		
	DL-MAP (Tree View)		

Setup Parameters

Zone Type	PUSC
DL-MAP Auto Decoding	Convolutional Coding (CC), Convolutional Turbo Coding (CTC)
Bandwidths	3.50, 5.00, 7.00, 8.75, 10.00 MHz
Cyclic Prefix Ratio (CP)	1/8
Span	5, 10, 20, 30 MHz
Frame Lengths	5, 10 ms
Demodulation	Auto, Manual, FCH
Frequency	Center, Signal Standard, Channel #, Closest Channel, Decrement/Increment Channel
Amplitude	Scale/Division, Power Offset, Auto Range, Adjust Range
Sweep	Single/Continuous, Trigger Sweep
Save/Recall	Setup, Measurement, Screen Shot (save only), to internal/external memory
Measurement Summary Screens	Overall Measurements, RF Measurements, Signal Quality Measurements

RF Measurements (Option 66) (Temperature range 15 °C to 35 °C)

RF Channel Power Accuracy ± 1.5 dB, ± 1.0 dB typical, (RF input -50 dBm to +20 dBm)

Demodulation (Option 67) (Temperature range 15 °C to 35 °C)

Frequency Error 0.02 ppm + Frequency Reference, 99 % confidence level
 Residual EVM (rms) 2.5 % typical, 3.0 % max, (RF Input -50 dBm to +20 dBm)

Over-the-Air (OTA) Measurements (Option 37)

Channel Power Monitor	Over time (one week), measurement time interval 1 to 60 sec
Preamble Scanner	Six Strongest Preambles
Auto Save	Yes
GPS Logging	Yes

General Specifications

System Parameters

System	Status (Temperature, Battery Info, Serial Number, Firmware Version, Options Installed) Self Test, Application Self Test, GPS (see Option 31)
System Options	Name, Date and Time, Brightness, Volume Language (English, French, German, Spanish, Chinese, Japanese, Korean, Italian, Russian, Portuguese) Reset (Factory Defaults, Master Reset, Update Firmware)
Internal Trace/Setup Memory	2,000 traces, 2,000 setups
External Trace/Setup Memory	Limited by size of USB Flash drive
Mode Switching	Auto-Stores/Recalls most recently used Setup Parameters in the Mode

File Management

File Types	Vary with measurement mode
File	Save, Recall, Copy, Delete
Save	Setups, Measurements, Screen Shots (JPEG)
Recall	Setups, Measurements
Copy	Selected file or files to internal/external memory (USB)
Delete	Selected file or files from internal/external memory (USB)
File Sort Method	By Name/Date/Type, Ascend/Descend

Connectors

VNA Port 1, VNA Port 2	Type N, female, 50 Ω
VNA Port Damage Level	23 dBm, ± 50 VDC
RF In Port	Type N, female, 50 Ω
RF In Port Damage Level	+33 dBm peak, ± 50 VDC, Maximum Continuous Input (≥ 10 dB attenuation)
Signal Generator Port	Type N, female, 50 Ω
Signal Generator Port Damage Level	+27 dBm, ± 16 VDC
GPS	SMA, female
External Power	5.5 mm barrel connector, 12.5 VDC to 15 VDC, < 4.0 A
USB Interface (2)	Type A (Connect USB Flash Drive and Power Sensor)
USB Interface	5-pin mini-B, Connect to PC for data transfer
Ethernet Interface	RJ45 connector for Ethernet 10-Base T
Headset Jack	3.5 mm mini-phone plug
External Reference In	BNC, female, 1 MHz, 1.2288 MHz, 1.544 MHz, 2.048 MHz, 2.4576 MHz, 4.8 MHz, 4.9152 MHz, 5 MHz, 9.8304 MHz, 10 MHz, 13 MHz, and 19.6608 MHz at -10 dBm to +10 dBm
Audio In (SINAD/Quieting)	BNC, female, Impedance 50 kΩ, Maximum Voltage > 1.77 Vrms (TIA-603-D compliant)
External Trigger/Clock Recovery	BNC, female, Maximum Input ± 5 VDC

Display

Type	Resistive TFT Touchscreen
Size	8.4 inch daylight viewable color LCD
Resolution	800 x 600
Pixel Defects	No more than five defective pixels (99.9989% good pixels)

Power

Field Replaceable Battery	Li-Ion, 7500 mAh rated capacity 40 W on battery power only
DC Power	Universal 110/220 V AC/DC Adapter 55 W running with AC/DC adapter while charging battery
Life Time Charging Cycles	> 300 (80 % of initial capacity)
Battery Operation	3.6 hours, typical
Battery Charging Limits	0 °C to +45 °C, Relative Humidity ≤ 80 %

General Specifications (Continued)

Regulatory Compliance

European Union	EMC 2014/30/EU, EN 61326:2013, CISPR 11/EN 55011, IEC/EN 61000-4-2/3/4/5/6/8/11 Low Voltage Directive 2014/35/EU Safety EN 61010-1:2010 RoHS Directive 2011/65/EU applies to instruments with CE marking placed on the market after July 22, 2017
Australia and New Zealand	RCM AS/NZS 4417:2012
Canada	ICES-1(A)/NMB-1(A)
South Korea	KCC-REM-A21-0004

Environmental

	MIL-PRF-28800F Class 2
Operating Temperature Range	-10 °C to 55 °C
Storage Temperature Range	-51 °C to 71 °C
Maximum Relative Humidity	95 % RH at 30 °C, non-condensing
Vibration, Sinusoidal	5 Hz to 55 Hz
Vibration, Random	10 Hz to 500 Hz
Half Sine Shock	30 g _n
Altitude	4600 meters, operating and non-operating
Explosive Atmosphere	MIL-PRF-28800F, Section 4.5.6.3 MIL-STD-810G, Method 511.5, Procedure 1

ESD

RF Port Center Pin	Withstands up to ±15 kV
--------------------	-------------------------

Size and Weight

Size	273 mm x 199 mm x 91 mm (10.7 in x 7.8 in x 3.6 in)
Weight	3.6 kg (7.9 lb)

Warranty

Duration	Standard three-year warranty (battery one-year warranty)
----------	--

Master Software Tools (for your PC)

Database Management

Full Trace Retrieval	Retrieve spectrum analyzer traces from instrument into one PC directory
Trace Catalog	Index all traces into one catalog
Trace Rename Utility	Rename measurement traces
Group Edit	Titles, subtitles, plot scaling, markers and limit lines, simultaneously on similar files
DAT File Converter	Converts HHST files to MST file format and vice-versa

Data Analysis

Trace Math and Smoothing	Compare multiple traces
Data Converter	Convert from/to Return Loss, VSWR, Cable Loss, DTF and also into Smith Charts
Measurement Calculator	Translates into other units

Report Generation

Report Generator	Includes GPS, power level, and calibration status along with measurements
Edit Graph	Change scale, limit lines, and markers
Report Format	Create reports in HTML for PDF format
Export Measurements	Export measurements to *.s2p, *.jpg or *.csv format
Notes	Annotate measurements

Mapping (GPS Required)

Spectrum Analyzer Mode	MapInfo, MapPoint
------------------------	-------------------

Folder Spectrogram (Spectrum Monitoring for Interference Analysis and Spectrum Clearing)

Folder Spectrogram – 2D View	Creates a composite file of multiple traces Peak Power, Total Power, Peak Frequency, Histogram, Average Power (Max/Min) File Filter (Violations over limit lines or deviations from averages) Playback
Video Folder Spectrogram – 2D View	Create AVI file to export for management review/reports
Folder Spectrogram – 3D View	Views (Set Threshold, Markers) - 3D (Rotate X, Y, Z Axis, Level Scale, Signal ID) - 2D View (Frequency or Time Domain, Signal ID) - Top Down Playback (Frequency and/or Time Domain)

List/Parameter Editors

Traces	Add, delete, and modify limit lines and markers
Antennas, Cables, Signal Standards	Modify instrument's Antenna, Cable, and Signal Standard List
Product Updates	Auto-checks Anritsu website for latest revision firmware
Languages	Customize non-English language menus
Display	Modify display settings

Script Master™

Channel Scanner Mode	Automate scan up to 1200 channels, repeat for sets of 20 channels, repeat all channels
----------------------	--

Connectivity

Connections	Connect to PC using USB, LAN, or Direct Ethernet connection
Network Search	Find all Anritsu handheld instruments on local network
Download	Download measurements and live traces to PC for storage and analysis
Upload	Upload measurements and other files from PC to instrument
Export	Measurements can be saved in various formats, depending on the measurement type, including JPEG, CSV, and Anritsu DAT format
Printing	Print individual or all measurement screens

 **easyTest Tools™** (for your PC)

Instrument Modes

Cable & Antenna Analyzer
Spectrum Analyzer

Commands

Display Image	Allows putting a custom image on the instrument screen
Recall Setup	Places the instrument into a known state; auto-advance to next command available
Prompt	Displays instructional messages on the instrument screen; timed advance to next command available; instrument users can be allowed or disallowed from making setup adjustments
Save	Allows automatic or manual saving of traces; auto-advance to next command available



Line Sweep Tools (for your PC)

Features Line Sweep Tools (LST) is a free PC based program that increases productivity for people who deal with numerous Cable and Antenna traces every day. LST is the next generation of Anritsu's familiar Handheld Software Tools (HHST) and shares its uncomplicated user interface, giving a new face to the term "ease of use."

Trace Capture

Browse to Instrument	View and copy traces from the test equipment to your PC using Windows Explorer
Open Legacy Files	Open DAT files captured with Handheld Software Tools v6.61
Open Current Files	Open VNA or DAT files
Capture Plots To	The Line Sweep Tools screen, DAT files, Database, or JPEG

Traces

Trace Types	Return Loss, VSWR, DTF-RL, DTF-VSWR, Cable Loss, Smith Chart, and PIM
Trace Formats	DAT, VNA, CSV, PNG, BMP, JPG, HTML, Data Base, and PDF

Report Generation

Report Generator	Includes GPS location along with measurements
Report Format	Create reports in HTML or PDF format
Report Setup	Report Title, Company, Prepared for, Location, Date and Time, Filename, Company logo (optionally set by user)
Trace Setup	One Trace Portrait Mode, Two Trace Portrait Modes, One Trace Landscape Mode

Trace Validation

Presets	Seven presets allow "one click" setting of up to 6 markers and one limit line
Marker Controls	Six regular Markers, Marker Peak, Marker Valley, Marker between, and frequency entry
Delta Markers	Six Delta markers
Limit Line	Enable and drag or value entry. Also works with presets
Next Trace Button	Next Trace and Previous Trace arrow keys allow quick switching between traces

Tools

Cable Editor	Allows creation of custom cable parameters (instrument type/model must match original)
Distance to Fault	Converts a Return Loss trace to a Distance to Fault trace (only *.dat and *.vna file types supported)
Measurement Calculator	Converts Real, Imaginary, Magnitude, Phase, RL, VSWR, Rho, and Transmit power
Signal Standard Editor	Creates new band and channel tables (instrument type/model must match original)
Renaming Grid	36 user definable phrases for creation of file names, trace titles, and trace subtitles

Connectivity

Connections	Ethernet, USB cable, and USB memory stick
-------------	---























Web Remote Control

Control	Full instrument control through a browser - all instrument functions except power switch and rotary knob
Connections	RJ45 Ethernet jack Third party Wi-Fi router
Protocol	HTTP/TCP/IP
Physical Layer	Cat 5 Cable, Wi-Fi router compatible
Software Required	HTML 5-compliant browser - Google Chrome, Mozilla Firefox
Operating System	iOS, Windows, Linux, Android operating systems that can host the HTML 5-compliant browser
Remote Hardware	PCs, tablets, and smart phones with Ethernet or Wi-Fi connection and an HTML 5-compliant browser
Download	Individual instrument files downloaded via browser Multiple instrument files and directories zipped and downloaded via browser File downloads are not supported by iOS Screen capture capability
Display Modes	Normal: All modes and displays supported Fast: Spectrum traces update faster (up to five updates per second)
Password	The instrument can be password protected Passwords may be used to manage who is controlling the instrument
Users/Instruments	One user/device can view and control many instruments

Programmable Remote Control

Functionality	Many instrument functions are programmable. See the Programming Manual for details.
Programming Language	Standard Commands for Programmable Instruments (SCPI)
Interfaces	Ethernet, USB
Available Drivers	LabView. Visit NI.com for driver

Ordering Information – Options





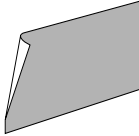

	S412E	Description
	500 kHz to 1.6 GHz	Vector Network Analyzer
	9 kHz to 1.6 GHz	Spectrum Analyzer
	10 MHz to 1.6 GHz	Power Meter
	500 kHz to 1.6 GHz	CW Signal Generator
	10 MHz to 1.6 GHz	NBFM Analyzer
Options		
	S412E-0010	High Voltage Variable Bias Tee
	S412E-0031	GPS Receiver (requires GPS antenna)
	S412E-0019	High-Accuracy Power Meter (requires External Power Sensor)
	S412E-0025	Interference Analyzer (Option 31 recommended)
	S412E-0027	Channel Scanner
	S412E-0006	6 GHz Coverage on Spectrum Analyzer
	S412E-0016	6 GHz Coverage on Vector Network Analyzer
	S412E-0015	Vector Voltmeter
	S412E-0431	Coverage Mapping (requires Option 31)
	S412E-0444	EMF Measurements (requires Anritsu Isotropic Antenna)
	S412E-0509	AM/FM/PM Analyzer
	S412E-0521	P25/P25p2 Analyzer Measurements
	S412E-0522	P25/P25p2 Coverage Measurements (requires Options 31 and 521)
	S412E-0531	NXDN Analyzer Measurements
	S412E-0532	NXDN Coverage Measurements (requires Options 31 and 531)
	S412E-0573	dPMR RF Analyzer Measurements
	S412E-0572	dPMR Coverage Measurements (requires Options 31 and 573)
	S412E-0581	TETRA Analyzer Measurements
	S412E-0582	TETRA Coverage Measurements (requires Options 31 and 581)
	S412E-0591	DMR (MOTOTRBO) Analyzer Measurements
	S412E-0592	DMR (MOTOTRBO) Coverage Measurements (requires Options 31 and 591)
	S412E-0731	PTC-ACSES Analyzer (requires Options 31)
	S412E-0733	PTC-ACSES Talk-Out Coverage (requires Options 31 and 731)
	S412E-0721	PTC-ICTR Analyzer
	S412E-0722	PTC-ICTR Coverage Measurements (requires Options 31 and 721)
	S412E-0541	LTE RF Measurements
	S412E-0542	LTE Modulation Quality
	S412E-0546	LTE Over-the-Air Measurements (requires Option 31)
	S412E-0551	TDD LTE RF Measurements (requires Option 541)
	S412E-0552	TDD LTE Modulation Quality (requires Option 542)
	S412E-0556	TDD LTE Over-the-Air Measurements (requires Options 31 & 546)
	S412E-0886	LTE 256QAM Demodulation (Requires Option 542 or 552)
	S412E-0880	GSM/GPRS/EDGE Measurements
	S412E-0046	IEEE 802.16 Fixed WiMAX RF Measurements (requires Option 6)
	S412E-0047	IEEE 802.16 Fixed WiMAX Demodulation (requires Option 6)
	S412E-0066	IEEE 802.16 Mobile WiMAX RF Measurements (requires Option 6)
	S412E-0067	IEEE 802.16 Mobile WiMAX Demodulation (requires Option 6)
	S412E-0037	IEEE 802.16 Mobile WiMAX Over-the-Air Measurements (requires Option 6; Option 31 required for full functionality)
	S412E-0098	Standard Calibration to ISO17025 and ANSI/NCSL Z540-1. Includes calibration certificate.
	S412E-0099	Premium Calibration to ISO17025 and ANSI/NCSL Z540-1. Includes calibration certificate, test report, and uncertainty data.





Standard Accessories (included with instrument)

Accessory	Description
	2000-1654-R Soft Carrying Case
	2000-1691-R Stylus with Coiled Tether
	633-75 Rechargeable Li-Ion Battery, 7500 mAh
	806-141-R Automotive Power Adapter, 12 VDC, 60 W

Accessory	Description
	2000-1797-R Screen Protector Film, 8.4 inch (2, one installed)
	3-2000-1498 USB A/5-pin mini-B Cable, 10 ft
	40-187-R AC-DC Adapter
	Certificate of Calibration and Conformance



USB Power Sensors (for complete ordering information, see the respective data sheets of each sensor)

Accessory	Description
	MA24330A Microwave CW USB Power Sensor, 10 MHz to 33 GHz, +20 dBm
	MA24340A Microwave CW USB Power Sensor, 10 MHz to 40 GHz, +20 dBm
	MA24350A Microwave CW USB Power Sensor, 10 MHz to 50 GHz, +20 dBm
	MA24208A Microwave Universal USB Power Sensor, 10 MHz to 8 GHz, +20 dBm to -60 dBm
	MA24218A Microwave Universal USB Power Sensor, 10 MHz to 18 GHz, +20 dBm to -60 dBm
	MA24106A High Accuracy RF Power Sensor, 50 MHz to 6 GHz, +23 dBm to -40 dBm

Accessory	Description
	MA24108A Microwave USB Power Sensor, 10 MHz to 8 GHz, +20 dBm to -40 dBm
	MA24118A Microwave USB Power Sensor, 10 MHz to 18 GHz, +20 dBm to -40 dBm
	MA24126A Microwave USB Power Sensor, 10 MHz to 26 GHz, +20 dBm to -40 dBm
	MA24105A Inline Dual Directional High Power Sensor, 350 MHz to 4 GHz, +3 dBm to +51.76 dBm
	MA25100A RF Power Indicator

Optional Accessories

Backpack and Transit Case

Accessory	Description
	67135 Anritsu Backpack (for Handheld Instrument and PC)
	760-243-R Large Transit Case with Wheels and Handle 56 cm x 45.5 cm x 26.5 cm (22.07" x 17.92" x 10.42")
	760-286-R Compact Transit Case with Wheels and Handle 55.6 cm x 35.5 cm x 22.9 cm (21.89" x 13.98" x 9.01")



Accessory	Description
	760-261-R Large Transit Case with Wheels and Handle 63.1 cm x 50 cm x 30 cm (24.83" x 19.69" x 11.88"), space for MA2700A, antennas, filters, instrument inside soft case, and other interference hunting accessories/tools
	760-262-R Transit Case for MA2700A, holds several Yagi antennas and filters/port extender 96.8 x 40.6 x 15.5 cm (38.12" x 16.00" x 6.12")
	760-271-R Transit Case for Portable Directional Antennas and Port Extender 52.4 cm x 42.8 cm x 20.6 cm (20.62" x 16.87" x 8.12") (for 2000-1777-R, 2000-1778-R, 2000-1779-R, 2000-1798-R)

Baseband Audio Generator and Oscilloscope

Accessory	Description
	2000-1897-R USB Baseband Audio generator and 2-Channel oscilloscope 10 MHz bandwidth, 8 kS buffer memory, 16 protocol serial decoder, USB connected and powered

Accessory	Description
	2000-1898-R USB Low Distortion Baseband Audio generator and 2-Channel oscilloscope 16-bit resolution, low distortion (96 dB SFDR), low noise (8.5 μ V RMS), 5 MHz bandwidth, 16 MS buffer memory, low-distortion signal generator, arbitrary waveform generator, USB powered

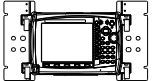

Miscellaneous Accessories



Accessory	Description
	MA2700A Handheld Interference Hunter (For full specifications, refer to the MA2700A Technical Data Sheet 11410-00692)
	2000-2149-R EMI Near-Field Probe Kit, 100 kHz to 1 GHz Requires 1092-172-R Type N to BNC Adapter and 1 m BNC to BNC Cable (sold separately) (For full specifications, refer to the Near-Field Probe Set User Guide 10580-00347)
	66864 Rack Mount Kit, Master Platform

Accessory	Description
	MA25200A High Power Tx/Rx Input Protection Module
	2000-1374-R External Dual Charger for Li-Ion Batteries

Full Temperature N-Type Coaxial Calibration Kits

-10 °C to +55 °C (see individual data sheets on www.anritsu.com)

Accessory	Description
	OSLN50A-8 High Performance Type N(m), DC to 8 GHz, 50 Ω
	TOSLN50A-8 High Performance with Through, Type N(m), DC to 8 GHz, 50 Ω





Accessory	Description
	OSLNF50A-8 High Performance with Through, Type N(m), DC to 8 GHz, 50 Ω
	TOSLNF50A-8 High Performance with Through, Type N(f), DC to 8 GHz, 50 Ω

Coaxial Calibration Components 50 Ω

Accessory	Description
	22N50 Precision N(m) Short/Open, 18 GHz
	22NF50 Precision N(f) Short/Open, 18 GHz
	2000-1915-R Precision Open/Short/Load, 4.3-10(m), DC to 6 GHz, 50 Ω
	2000-1619-R Precision Open/Short/Load, 7/16 DIN(f), DC to 6.0 GHz, 50 Ω
	SM/PL-1 Precision Load, N(m), 42 dB, 6.0 GHz, 50 Ω

Accessory	Description
	28N50-2 Precision Termination, DC to 18 GHz, 50 Ω, N(m)
	2000-1914-R Precision Open/Short/Load, 4.3-10(f), DC to 6 GHz, 50 Ω
	2000-1618-R Precision Open/Short/Load, 7/16 DIN(m), DC to 6.0 GHz, 50 Ω
	28NF50-2 Precision Termination, DC to 18 GHz, 50 Ω, N(f)
	SM/PLNF-1 Precision Load, N(f), 42 dB, 6.0 GHz, 50 Ω

Coaxial Calibration Components, 75 Ω

Accessory	Description	Accessory	Description
	12N50-75B Matching Pad, DC to 3 GHz, 50 Ω to 75 Ω	1091-56-R	Short, TNC(f), DC to 18 GHz
	22N75 Open/Short, N(m), DC to 3 GHz, 75 Ω	1091-54-R	Short, TNC(m), DC to 18 GHz
	22NF75 Open/Short, N(f), DC to 3 GHz, 75 Ω	1015-54-R	Termination, TNC(f), DC to 18 GHz
	26NF75A Precision Termination, N(f), DC to 3 GHz, 75 Ω	1015-55-R	Termination, TNC(m), DC to 18 GHz
	1091-53-R Open, TNC(m), DC to 18 GHz	1091-55-R	Open, TNC(f), DC to 18 GHz
	26N75A Precision Termination, N(m), DC to 3 GHz, 75 Ω		

Adapters Accessory	Description
	1091-26-R SMA(m) to N(m), DC to 18 GHz, 50 Ω
	1091-27-R SMA(f) to N(m), DC to 18 GHz, 50 Ω
	1091-80-R SMA(m) to N(f), DC to 18 GHz, 50 Ω
	1091-81-R SMA(f) to N(f), DC to 18 GHz, 50 Ω
	1091-172-R BNC(f) to N(m), DC to 1.3 GHz, 50 Ω
	1091-315-R DC to 18 GHz, TNC(m) to N(f), 50 Ω
	1091-324-R DC to 18 GHz, TNC(f) to N(m), 50 Ω
	1091-325-R DC to 18 GHz, TNC(m) to N(m), 50 Ω
	1091-465-R Adapter, DC to 6 GHz, 4.3-10(f) to N(f), 50 Ω
	513-62-R DC to 18 GHz, TNC(f) to N(f), 50 Ω
	1091-323-R DC to 18 GHz, TNC(f) to TNC(f), 50 Ω

Precision Adapters Accessory	Description
	34NN50A N(m) to N(m), DC to 18 GHz, 50 Ω

Accessory	Description
	510-102-R N(m) to N(m), DC to 11 GHz, 50 Ω, 90 degrees right angle
	510-90-R 7/16 DIN(f) to N(m), DC to 7.5 GHz, 50 Ω
	510-91-R 7/16 DIN(f) to N(f), DC to 7.5 GHz, 50 Ω
	510-92-R 7/16 DIN(m) to N(m), DC to 7.5 GHz, 50 Ω
	510-93-R 7/16 DIN(m) to N(f), DC to 7.5 GHz, 50 Ω
	510-96-R 7/16 DIN(m) to 7/16 DIN(m), DC to 7.5 GHz, 50 Ω
	510-97-R 7/16 DIN(f) to 7/16 DIN(f), DC to 7.5 GHz, 50 Ω
	1091-317-R DC to 18 GHz, TNC(m) to SMA(f), 50 Ω
	1091-467-R Adapter, DC to 6 GHz, 4.3-10(m) to N(f), 50 Ω
	1091-318-R DC to 18 GHz, TNC(m) to SMA(m), 50 Ω
	1091-326-R DC to 18 GHz, TNC(m) to TNC(m), 50 Ω

Accessory	Description
	34NFN50 N(f) to N(f), DC to 18 GHz, 50 Ω

Bandpass Filters

Accessory	Description
	1030-114-R 806 MHz to 869 MHz, N(m) to SMA(f), 50 Ω
	1030-109-R 824 MHz to 849 MHz, N(m) to SMA(f), 50 Ω
	1030-110-R 880 MHz to 915 MHz, N(m) to SMA(f), 50 Ω
	1030-105-R 890 MHz to 915 MHz Band, 0.41 dB loss, N(m) to SMA(f), 50 Ω
	1030-111-R 1850 MHz to 1910 MHz, N(m) to SMA(f), 50 Ω
	1030-106-R 1710 MHz to 1790 MHz Band, 0.34 dB loss, N(m) to SMA(f), 50 Ω
	1030-107-R 1910 MHz to 1990 MHz Band, 0.41 dB loss, N(m) to SMA(f), 50 Ω
	1030-112-R 2400 MHz to 2484 MHz, N(m) to SMA(f), 50 Ω
	1030-149-R High Pass, 150 MHz, N(m) to N(f), 50 Ω
	1030-150-R High Pass, 400 MHz, N(m) to N(f), 50 Ω
	1030-151-R High Pass, 700 MHz, N(m) to N(f), 50 Ω
	1030-152-R Low Pass, 200 MHz, N(m) to N(f), 50 Ω
	1030-153-R Low Pass, 550 MHz, N(m) to N(f), 50 Ω
	1030-155-R 2500 MHz to 2700 MHz, N(m) to N(f), 50 Ω

Attenuators

Accessory	Description
	1010-121-R 40 dB, 100 W, DC to 18 GHz, N(f) to N(m), Uni-directional
	3-1010-122 20 dB, 5 W, DC to 12.4 GHz, N(m) to N(f)
	3-1010-123 30 dB, 50 W, DC to 8.5 GHz, N(m) to N(f)
	3-1010-124 40 dB, 100 W, DC to 8.5 GHz, N(f) to N(m), Uni-directional

Accessory	Description
	42N50-20 20 dB, 5 W, DC to 18 GHz, N(m) to N(f)
	42N50A-30 30 dB, 50 W, DC to 18 GHz, N(m) to N(f)
	1010-127-R 30 dB, 150 W, DC to 3 GHz, N(m) to N(f)
	1010-128-R 40 dB, 150 W, DC to 3 GHz, N(m) to N(f)

Phase-Stable Test Port Cables, Armored (recommended for use with tightly spaced connectors and other general purpose applications)



Accessory	Description
	15NNF50-1.5C 1.5 m, DC to 6 GHz, N(m) to N(f), 50 Ω
	15NN50-1.5C 1.5 m, DC to 6 GHz, N(m) to N(m), 50 Ω
	15NNF50-3.0C 3.0 m, DC to 6 GHz, N(m) to N(f), 50 Ω
	15NN50-3.0C 3.0 m, DC to 6 GHz, N(m) to N(m), 50 Ω
	15NNF50-5.0C 5.0 m, DC to 6 GHz, N(m) to N(f), 50 Ω
15NN50-5.0C 5.0 m, DC to 6 GHz, N(m) to N(m), 50 Ω	



Accessory	Description
	15NDF50-1.5C 1.5 m, DC to 6 GHz, N(m) to 7/16 DIN(f), 50 Ω
	15ND50-1.5-R 1.5 m, DC to 6 GHz, N(m) to 7/16 DIN(m), 50 Ω
	15N43M50-1.5C Test Port Extension Cable, Armored, 1.5 meters, DC to 6 GHz, N(m) to 4.3-10(m)
	15N43F50-1.5C Test Port Extension Cable, Armored, 1.5 meter, DC to 6 GHz, N(m) to 4.3-10(f)
	15N43M50-3.0C Test Port Extension Cable, Armored, 3 meters, DC to 6 GHz, N(m) to 4.3-10(m)
	15N43F50-3.0C Test Port Extension Cable, Armored, 3 meters, DC to 6 GHz, N(m) to 4.3-10(f)









Interchangeable Adapter, Phase Stable Test Port Cables, Armored w/Reinforced Grip (recommended for cable and antenna line sweep applications. It uses the same ruggedized grip as the Reinforced grip series cables. Now you can also change the adapter interface on the grip to four different connector types.)

Accessory	Description
	15RCN50-1.5-R 1.5 m, DC to 6 GHz, N(m), N(f), 7/16 DIN(m), 7/16 DIN(f), 50 Ω
	15RCN50-3.0-R 3.0 m, DC to 6 GHz, N(m), N(f), 7/16 DIN(m), 7/16 DIN(f), 50 Ω

GPS and Broadband Antennas (active)

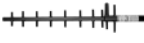
Accessory	Description
	2000-1528-R Magnet Mount, SMA(m) with 5 m (16.4 ft) cable, requires 5 VDC
	2000-1652-R Magnet Mount, SMA(m) with 0.3 m (1 ft) cable, requires 3.3 VDC or 5 VDC

Accessory	Description
	2000-1760-R Miniature Antenna, SMA(m), requires 2.5 VDC to 3.7 VDC
	2000-1946-R Mag Mount Broadband Antenna Cable 1: 617 MHz to 960 MHz, 3 dBi peak gain, 1710 MHz to 3700 MHz, 4 dBi peak gain, N(m), 50 Ω, 10 ft Cable 2: 3000 MHz to 6000 MHz, 5 dBi peak gain, N(m), 50 Ω, 10 ft Cable 3: GPS 26 dB gain, SMA(m), 50 Ω, 10 ft

Accessory	Description
	2000-1411-R 824 MHz to 896 MHz, N(f), 12.3 dBi, Yagi
	2000-1412-R 885 MHz to 975 MHz, N(f), 12.6 dBi, Yagi
	2000-1413-R 1710 MHz to 1880 MHz, N(f), 12.3 dBi, Yagi
	2000-1414-R 1850 MHz to 1990 MHz, N(f), 11.4 dBi, Yagi
	2000-1415-R 2400 MHz to 2500 MHz, N(f), 14.1 dBi, Yagi
	2000-1416-R 1920 MHz to 2170 MHz, N(f), 14.3 dBi, Yagi
	2000-1659-R 698 MHz to 787 MHz, N(f), 10.1 dBi, Yagi
	2000-1660-R 1425 MHz to 1535 MHz, N(f), 14.3 dBi, Yagi
	2000-2107-R Log Periodic, 20 MHz to 8.5 GHz



Accessory	Description
	2000-1726-R 2500 MHz to 2700 MHz, N(f), 14.1 dBi, Yagi
	2000-1798-R Port Extender, DC to 6 GHz
	2000-1748-R Log Periodic, 1 GHz to 18 GHz, N(f), 6 dBi, typical
	2000-1777-R 9 kHz to 20 MHz, N(f) (requires port extender 2000-1798-R when used with MA2700A)
	2000-1778-R 20 MHz to 200 MHz, N(f) (requires port extender 2000-1798-R when used with MA2700A)
	2000-1779-R 200 MHz to 500 MHz, N(f) (requires port extender 2000-1798-R when used with MA2700A)
	2000-1812-R Portable Yagi Antenna, 450 MHz to 512 MHz, N(f), 7.1 dBi
	2000-1825-R Portable Yagi Antenna, 380 MHz to 430 MHz, N(f), 7.1 dBi

Portable Antennas (requires 1091-27-R SMA(f) to N(m) or 1091-172-R BNC(f) to N(m) adapter)

Accessory	Description
	2000-1200-R 806 MHz to 866 MHz, SMA(m), 50 Ω
	2000-1473-R 870 MHz to 960 MHz, SMA(m), 50 Ω
	2000-1035-R 896 MHz to 941 MHz, SMA(m), 50 Ω (1/2 wave)
	2000-1030-R 1710 MHz to 1880 MHz, SMA(m), 50 Ω (1/2 wave)
	2000-1474-R 1710 MHz to 1880 MHz with knuckle elbow (1/2 wave)
	2000-1031-R 1850 MHz to 1990 MHz, SMA(m), 50 Ω (1/2 wave)



Accessory	Description
	2000-1475-R 1920 MHz to 1980 MHz and 2110 MHz to 2170 MHz, SMA(m), 50 Ω
	2000-1032-R 2400 MHz to 2500 MHz, SMA(m), 50 Ω (1/2 wave)
	2000-1751-R 698 MHz to 960 MHz, 1710 MHz to 2170 MHz 2500 MHz to 2700 MHz, SMA(m), 2 dB, typical, 50 Ω
	2000-1361-R 2400 MHz to 2500 MHz, 5000 MHz to 6000 MHz, SMA(m), 50 Ω
	2000-1636-R Antenna Kit (Consists of: 2000-1030-R, 2000-1031-R, 2000-1032-R, 2000-1200-R, 2000-1035-R, 2000-1361-R, and carrying pouch)
	2000-1487-R Telescoping Whip Antenna, BNC

Isotropic Antennas

Accessory	Description
	2000-1800-R H-Field, 9 kHz to 300 MHz
	2000-1792-R E-Field, 30 MHz to 3 GHz

Accessory	Description
	2000-1791-R E-Field, 0.7 GHz to 6 GHz

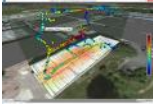
NEON® MA8100A Signal Mapper

Accessory	Description	Accessory	Description
	MA8100A-000 NEON Signal Mapper with Anritsu Integration and Tracking Unit. Includes 3 months NEON Software License with 3 months of maintenance and support and 3 months of Cloud Service (PN: 2300-607).		2300-606 Perpetual NEON Software License with 3 years of maintenance and support and 3 years of Cloud Service. Part number can also be used to order a perpetual license after a limited term license has expired.
	MA8100A-001 NEON Signal Mapper with Anritsu Integration and Tracking Unit. Includes 1 year NEON Software License with 1 year of maintenance and support and 1 year of Cloud Service (PN: 2300-574).		2300-612 Renewal of 1 year NEON Software License with 1 year of maintenance and support and 1 year of Cloud Service.
	MA8100A-003 NEON Signal Mapper with Anritsu Integration and Tracking Unit. Includes 3 year NEON Software License with 3 years of maintenance and support and 3 years of Cloud Service (PN: 2300-575).		2300-613 Renewal of 3 year NEON Software License with 3 years of maintenance and support and 3 years of Cloud Service.
	2000-1852-R NEON Tracking Unit (includes USB cable and belt clip, Worldwide version)		
	2000-2015-R NEON Tracking Unit (includes USB cable and belt clip, Japan version)		
	2000-1853-R Belt clip (for NEON Tracking Unit)		

Manuals, Related Literature (Soft copy at www.anritsu.com)

Part Number	Description
10100-00065	Product Information, Compliance, and Safety
10580-00318	LMR Master User Guide
10580-00289	Vector Network Analyzer Measurement Guide
10580-00243	Land Mobile Radio Measurement Guide
10580-00241	Cable and Antenna Analyzer Measurement Guide
10580-00349	Spectrum Analyzer Measurement Guide
10580-00240	Power Meter Measurement Guide
10580-00234	3GPP Signal Analyzer Measurement Guide
10580-00236	WiMAX Signal Analyzer Measurement Guide
10580-00455	EMF Measurement Guide
10580-00319	Programming Manual

Troubleshooting Guides (Soft copy at www.anritsu.com)

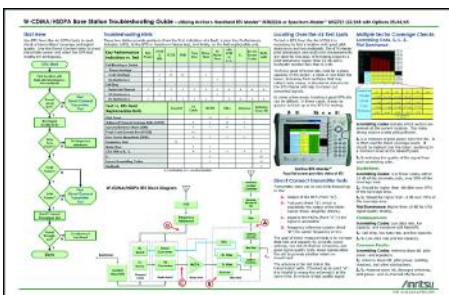

Part Number	Description
11410-00551	Spectrum Analyzers
11410-00472	Interference
11410-00566	LTE eNode Testing
11410-00466	GSM/GPRS/EDGE Base Stations
11410-00473	Cable, Antenna, and Component Troubleshooting Guide
11410-00427	Understanding Cable & Antenna Analysis White Paper



+1 (888) 880-6804
sales@testforce.com

Training at Anritsu

Anritsu has designed courses to help you stay up to date with technologies important to your job. For available training courses, visit: <https://www.anritsu.com> and search for training and education.

Anritsu Advancing beyond

• United States

Anritsu Americas Sales Company
450 Century Parkway, Suite 190,
Allen, TX 75013, U.S.A.
Phone: +1-800-Anritsu (1-800-267-4878)

• Canada

**Anritsu Electronics Ltd.
Americas Sales and Support**
450 Century Parkway, Suite 190,
Allen, TX 75013, U.S.A.
Phone: +1-800-Anritsu (1-800-267-4878)

• Brazil

Anritsu Eletronica Ltda.
Praça Amadeu Amaral, 27 - 1 Andar
01327-010 - Bela Vista - Sao Paulo - SP, Brazil
Phone: +55-11-3283-2511
Fax: +55-11-3288-6940

• Mexico

Anritsu Company, S.A. de C.V.
Blvd Miguel de Cervantes Saavedra #169 Piso 1,
Col. Granada, Mexico, Ciudad de Mexico,
11520, MEXICO
Phone: +52-55-4169-7104

• United Kingdom

Anritsu EMEA Ltd.
200 Capability Green,
Luton, Bedfordshire, LU1 3LU, U.K.
Phone: +44-1582-433200
Fax: +44-1582-731303

• France

Anritsu S.A.
12 avenue du Québec, Immeuble Goyave,
91140 VILLEBON SUR YVETTE, France
Phone: +33-1-60-92-15-50

• Germany

Anritsu GmbH
Nemetschek Haus, Konrad-Zuse-Platz 1,
81829 München, Germany
Phone: +49-89-442308-0
Fax: +49-89-442308-55

• Italy

Anritsu S.r.l.
Spaces Eur Arte, Viale dell'Arte 25, 00144 Roma, Italy
Phone: +39-6-509-9711

List Revision Date: 20230901

• Sweden

Anritsu AB
Kistagången 20 B, 2 tr, 164 40 Kista, Sweden
Phone: +46-8-534-707-00

• Finland

Anritsu AB
Technopolis Aviapolis, Teknobulevardi 3-5 (D208.5),
FI-01530 Vantaa, Finland
Phone: +358-20-741-8100

• Denmark

Anritsu A/S
c/o Regus Winghouse, Ørestads Boulevard 73, 4th
floor,
2300 Copenhagen S, Denmark
Phone: +45-7211-2200

• Spain

**Anritsu EMEA Ltd.
Representation Office in Spain**
Paseo de la Castellana, 141,
Planta 5, Edificio Cuzco IV
28046, Madrid, Spain
Phone: +34-91-572-6761

• Austria

Anritsu EMEA GmbH
Am Belvedere 10, A-1100 Vienna, Austria
Phone: +43-(0)1-717-28-710

• United Arab Emirates

**Anritsu EMEA Ltd.
Anritsu A/S**
Office No. 164, Building 17, Dubai Internet City
P. O. Box - 501901, Dubai, United Arab Emirates
Phone: +971-4-3758479

• India

Anritsu India Private Limited
6th Floor, Indiqube ETA, No.38/4, Adjacent to EMC2,
Doddanekundi, Outer Ring Road,
Bengaluru - 560048, India
Phone: +91-80-6728-1300
Fax: +91-80-6728-1301

• Singapore

Anritsu Pte. Ltd.
1 Jalan Kilang Timor, #07-04/06 Pacific Tech Centre
Singapore 159303
Phone: +65-6282-2400
Fax: +65-6282-2533

• Vietnam

Anritsu Company Limited
16th Floor, Peakview Tower, 36 Hoang Cau Street,
O Cho Dua Ward, Dong Da District, Hanoi, Vietnam
Phone: +84-24-3201-2730

• P.R. China (Shanghai)

Anritsu (China) Co., Ltd.
Room 2701-2705, Tower A, New Caohejing
International Business Center No. 391 Gui Ping Road
Shanghai, 200233, P.R. China
Phone: +86-21-6237-0898
Fax: +86-21-6237-0899

• P.R. China (Hong Kong)

Anritsu Company Ltd.
Unit 1006-7, 10/F., Greenfield Tower, Concordia Plaza,
No. 1 Science Museum Road, Tsim Sha Tsui East,
Kowloon, Hong Kong, P.R. China
Phone: +852-2301-4980
Fax: +852-2301-3545

• Japan

Anritsu Corporation
8-5, Tamura-cho, Atsugi-shi, Kanagawa, 243-0016
Japan
Phone: +81-46-296-6509
Fax: +81-46-225-8352

• South Korea

Anritsu Corporation, Ltd.
8F, A TOWER, 20, Gwacheondaero 7-gil, Gwacheon-si,
Gyeonggi-do, 13840, Republic of Korea
Phone: +82-2-6259-7300
Fax: +82-2-6259-7301

• Australia

Anritsu Pty. Ltd.
Unit 20, 21-35 Ricketts Road,
Mount Waverley, Victoria 3149, Australia
Phone: +61-3-9558-8177
Fax: +61-3-9558-8255

• Taiwan

Anritsu Company Inc.
7F, No. 316, Sec. 1, NeiHu Rd., Taipei 114, Taiwan
Phone: +886-2-8751-1816
Fax: +886-2-8751-1817