

# 7705 40-channel, Single-pole Control Module

## Datasheet



The 7705 plug-in module offers 40 channels of independent switching. These channels are designed to control power to the DUT and switching loads. They can also directly control light indicators, relays, etc.

### Key Features

- 300 V, 2 A capacity
- Two 50-pin female D-sub connectors are standard for secure hook-up and quick teardown
- Relay closures stored in onboard memory

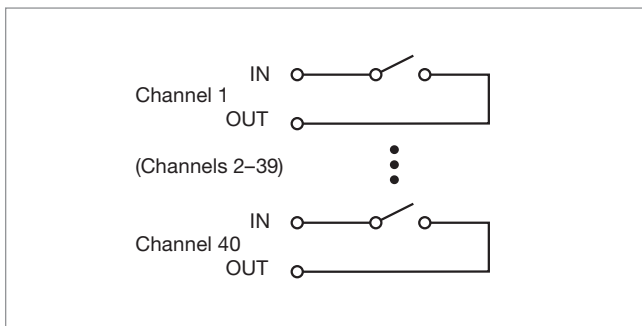

### Specifications

#### Inputs

<b>Maximum Signal Level</b>	300 VDC or rms, 2 A switched, 60 W (DC, resistive), 125 VA (AC, resistive).
<b>Contact Life</b>	<b>No Load<sup>1</sup>:</b> 10 <sup>8</sup> closures. <b>At Maximum Signal Levels:</b> 10 <sup>5</sup> closures. 1. Minimum signal level 10 mV, 10 $\mu$ A.
<b>Channel Resistance (per conductor)</b>	<1 $\Omega$ .
<b>Contact Potential</b>	$\leq$ 4 $\mu$ V per contact.
<b>Offset Current</b>	<100 pA.
<b>Actuation Time</b>	3 ms.
<b>Isolation</b>	Channel to Channel: >10 <sup>9</sup> $\Omega$ , <50 pF. Common Mode: >10 <sup>9</sup> $\Omega$ , <100 pF.
<b>Crosstalk (1 MHz, 50 <math>\Omega</math> load)</b>	<-35 dB.
<b>Insertion Loss (50 <math>\Omega</math> source, 50 <math>\Omega</math> load)</b>	<0.3 dB below 1 MHz, <3 dB below 10 MHz.
<b>Common Mode Voltage</b>	300 V between any terminal and chassis.

### General

<b>Relay Switch Configuration</b>	40 independent channels of 1-pole switching. Isolated from internal DMM.
<b>Contact Configuration</b>	1 pole Form A.
<b>Relay Type</b>	Latching electromechanical.
<b>Connector Type</b>	Two 50-pin female D-sub connectors.
<b>Environmental and Safety</b>	<b>Operating Environment:</b> Specified for 0° to 50°C. Specified to 80% R.H. at 35°C. <b>Storage Environment:</b> -25° to 65°C. <b>EMC:</b> Conforms to European Union EMC Directive. <b>Safety:</b> Conforms to European Union Low Voltage Directive <b>RoHS:</b> Conforms to European Union RoHS Directive
<b>Weight</b>	0.45 kg (1 lb).

### Supplied Accessories

7703-306A	50-pin D-Sub Male Shell Connector Kit, quantity 2
-----------	---

### Available Accessories

7705-MTC-2	50 Pin Male to Female D-sub Cable, 2 m (6.6 ft).
7788	50-pin D-Sub male connector kit, quantity 2
7790	50-pin male, 50-pin female, 25-pin male D-shell IDC connectors

### Available Services

7705-3Y-EW	1-year factory warranty extended to 3 years from date of shipment
------------	---

### Ordering Information

7705	40-channel, Single-pole Control Module
Warranty	1 year

**Contact Information:**

**Australia\*** 1 800 709 465  
**Austria** 00800 2255 4835  
**Balkans, Israel, South Africa and other ISE Countries** +41 52 675 3777  
**Belgium\*** 00800 2255 4835  
**Brazil** +55 (11) 3759 7627  
**Canada** 1 800 833 9200  
**Central East Europe / Baltics** +41 52 675 3777  
**Central Europe / Greece** +41 52 675 3777  
**Denmark** +45 80 88 1401  
**Finland** +41 52 675 3777  
**France\*** 00800 2255 4835  
**Germany\*** 00800 2255 4835  
**Hong Kong** 400 820 5835  
**India** 000 800 650 1835  
**Indonesia** 007 803 601 5249  
**Italy** 00800 2255 4835  
**Japan** 81 (3) 6714 3010  
**Luxembourg** +41 52 675 3777  
**Malaysia** 1 800 22 55835  
**Mexico, Central/South America and Caribbean** 52 (55) 56 04 50 90  
**Middle East, Asia, and North Africa** +41 52 675 3777  
**The Netherlands\*** 00800 2255 4835  
**New Zealand** 0800 800 238  
**Norway** 800 16098  
**People's Republic of China** 400 820 5835  
**Philippines** 1 800 1601 0077  
**Poland** +41 52 675 3777  
**Portugal** 80 08 12370  
**Republic of Korea** +82 2 6917 5000  
**Russia / CIS** +7 (495) 6647564  
**Singapore** 800 6011 473  
**South Africa** +41 52 675 3777  
**Spain\*** 00800 2255 4835  
**Sweden\*** 00800 2255 4835  
**Switzerland\*** 00800 2255 4835  
**Taiwan** 886 (2) 2656 6688  
**Thailand** 1 800 011 931  
**United Kingdom / Ireland\*** 00800 2255 4835  
**USA** 1 800 833 9200  
**Vietnam** 12060128

\* European toll-free number. If not accessible, call: +41 52 675 3777



Find more valuable resources at [TEK.COM](http://TEK.COM)

Copyright © Tektronix. All rights reserved. Tektronix products are covered by U.S. and foreign patents, issued and pending. Information in this publication supersedes that in all previously published material. Specification and price change privileges reserved. TEKTRONIX and TEK are registered trademarks of Tektronix, Inc. All other trade names referenced are the service marks, trademarks or registered trademarks of their respective companies.

